



AEW Dual Output Series

30W DC-DC Converters

Feature:

- Two wide input voltage range
- Input over-/under-voltage protection
- Trim function
- Output over-voltage shutdown
- Output over-current protection
- Load shortcircuit protection
- High efficiency, density and reliability
- Low profile (Typical height: 12.7mm)
- UL CSA TUV approved
- Meet with FCC Class A

Size: 76.2%~~63.5~~12.7 (3.0" ~~2.5~~0.5")

Application:

- * Data collection
- * Program controlled equipment
- * Instruments
- * Communication system
- * Separately power supply system

Introduction:

AEW series adopt 3"x2.5" standard industrial encapsulation and pin with height less than 0.5", providing 2-output and 3-output.

AEW 30W 2-output and AEW 30W 3-output products are compact, high performance DC/DC converters. They adopt state-of-the-art SMT and sealing structure, feature high power density, small weight, and are suitable for applications requiring isolated stabilized voltage. They provide +-5V, +-12V, +-15V 2-output or 5V/+-12V, 5V/+-15V 3-output. The input voltage can be 24VDC or 48VDC.

With low output ripple and noise, highly stabilized voltage accuracy, high efficiency and reliability, the AEW 2-output and AEW 3-output series are suitable for by-board distributed power supply system.

	USA	Europe	Asia
TEL:	1-760-930-4600	44-(0)1384-842-211	852-2437-9662
FAX:	1-760-930-0698	44-(0)1384-843-355	852-2402-4426



List 1 AEW dual output products list

Model	Input voltage (V)	Output voltage (V)	Output current (A)	Product code
<i>AEW03AA24</i>	18-36	±5	±3.0	02280360
<i>AEW01BB24</i>	18-36	±12	±1.25	02280358
<i>AEW01CC24</i>	18-36	±15	±1.0	02280362
<i>AEW03AA48</i>	36-72	±5	±3.0	02280359
<i>AEW01BB48</i>	36-72	±12	±1.25	02280264
<i>AEW01CC48</i>	36-72	±15	±1.0	02280361

Absolute maximum value:

The following list is the maximum stress that the module can endure. If the module works under the condition for a long time, it may short the lifetime and have bad effect on its reliability. If the environmental stress exceeds the absolute maximum value listed below, the module may be damaged forever.

List 2 Extreme limit parameters

Parameters	Model	Minimum	Maximum	Unit	Note
Input voltage (+Vin~-Vin)	Rated 24V	—	42	Vdc	Continuously
		—	50	Vdc	Instant < 100ms
	Rated 48V	—	82	Vdc	Continuously
		—	100	Vdc	Instant < 100ms
CNT voltage (CNT~-Vin)	Rated 24V	—	42	Vdc	Continuously
	Rated 48V	—	82	Vdc	Continuously
Isolated voltage Input-output	All	—	2000	Vdc	
Operating ambient temperature	All	-25	+70	°C	
Storage temperature	All	-40	+105	°C	
Pin soldering temperature	All	—	260	°C	Wave solder < 12S

Principle

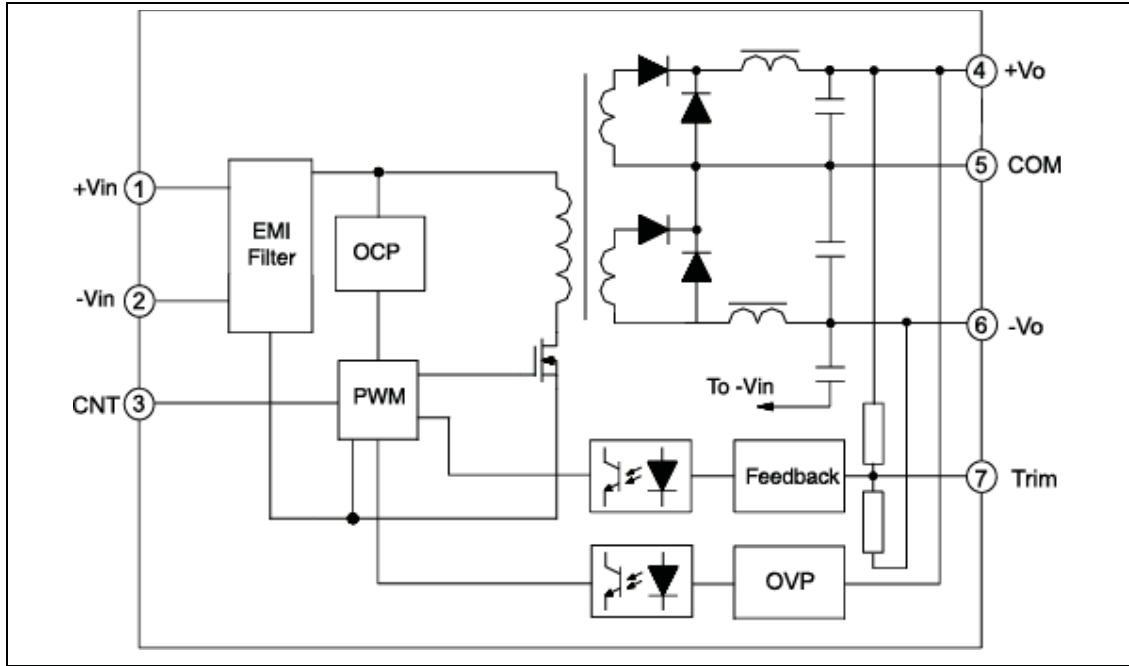

Outline Size

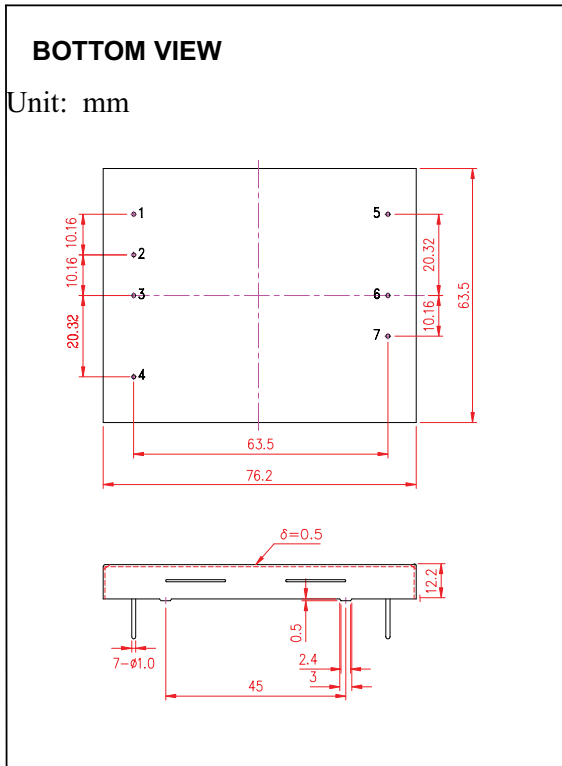

Pin definition:

Pin	Symbol	Function
1	TRM	Trim
2	+Vo	Output +
3	COM	Output common ground
4	-Vo	Output -
5	CNT	Remote control
6	+Vin	Input +
7	-Vin	Input -

Electrical Characteristic (continued)

List 3 Input characteristics

Parameter	Model	Symbol	Minimum	Typical	Maximum	Unit
Input voltage range	Rated 24V	V_i	18	24	36	Vdc
	Rated 48V	V_i	36	48	72	Vdc
Maximum input current (the lowest input voltage, rated output)	AEW03AA24	I_{in}	—	—	2.03	A
	AEW01BB24	I_{in}	—	—	1.98	A
	AEW01CC24	I_{in}	—	—	1.98	A
	AEW03AA48	I_{in}	—	—	1.01	A
	AEW01BB48	I_{in}	—	—	0.99	A
	AEW01CC48	I_{in}	—	—	0.99	A
Input under-voltage shutdown	Rated 24V	—	14	15.5	18	Vdc
	Rated 48V	—	30	33	36	Vdc
Input over-voltage shutdown	Rated 24V	—	36	40	42	Vdc
	Rated 48V	—	72	76	82	Vdc
Input reflected current (5Hz-20MHz, 12 μ H impedance, TA=25°C reference figure 3)	All	—	—	5	10	mAp-p

Note: there is no fuse inside the power module. Recommend adding an external fuse in the input of the module.

A common fuse can be selected, the value can refer to the maximum current in the list 3.

List 4 Remote ON/OFF

Parameter	Model	Symbol	Minimum	Typical	Maximum	Unit
Remote ON/OFF logic	All	CNT	CNT in the midair, output ON CNT connects with -VIN, output OFF			—

Electrical Characteristic (continued)

List 5 Output characteristics

Parameter	Model	Symbol	Minimum	Typical	Maximum	Unit
Output setpoint voltage Condition: 1. 25°C ambient temperature, 2. rated input, 3. full load	AEW03AA24	$V_{o,set}$! 4.95	! 5.0	! 5.05	Vdc
	AEW01BB24	$V_{o,set}$! 11.88	! 12.0	! 12.12	Vdc
	AEW01CC24	$V_{o,set}$! 14.85	! 15.0	! 15.15	Vdc
	AEW03AA48	$V_{o,set}$! 4.95	! 5.0	! 5.05	Vdc
	AEW01BB48	$V_{o,set}$! 11.88	! 12.0	! 12.12	Vdc
	AEW01CC48	$V_{o,set}$! 14.85	! 15.0	! 15.15	Vdc
Output voltage Conditions: 1. Full input range, output range and ambient temperature range. 2. 10%—100% load.	AEW03AA24	! V_o	! 4.83	! 5.0	! 5.17	Vdc
	AEW01BB24	! V_o	! 11.6	! 12.0	! 12.4	Vdc
	AEW01CC24	! V_o	! 14.15	! 15.0	! 15.85	Vdc
	AEW03AA48	! V_o	! 4.83	! 5.0	! 5.17	Vdc
	AEW01BB48	! V_o	! 11.6	! 12.0	! 12.4	Vdc
	AEW01CC48	! V_o	! 14.15	! 15.0	! 15.85	Vdc
Line regulation Low—high	All	—	—	0.01%	0.2%	—
Load regulation 10%—100% rated load (+ I_o =- I_o)	All	—	—	0.01%	0.5%	—
Temperature coefficient	All	Tcoeff	—	—	0.02%	/°C
Output ripple typical value (testing method reference to figure 4)	AEW03AA24	—	—	11	25	mVrms
	AEW01BB24	—	—	11	25	mVrms
	AEW01CC24	—	—	15	25	mVrms
	AEW03AA48	—	—	15	25	mVrms
	AEW01BB48	—	—	16	25	mVrms
	AEW01CC48	—	—	12	25	mVrms

Electrical Characteristic (continued)

List 5 Output characteristics (continued)

Parameter	Model	Symbol	Minimum	Typical	Maximum	Unit
Output ripple&noise peak-peak value (testing method reference to figure 4)	AEW03AA24	—	—	50	120	mVp-p
	AEW01BB24	—	—	65	120	mVp-p
	AEW01CC24	—	—	70	120	mVp-p
	AEW03AA48	—	—	60	120	mVp-p
	AEW01BB48	—	—	80	120	mVp-p
	AEW01CC48	—	—	70	120	mVp-p
Output current (when $I_o < I_{o,min}$, the module can operate normally, but the ripple&noise may exceed the standards.)	AEW03AA24	$\pm I_o$	± 0.3	—	± 3.0	A
	AEW01BB24	$\pm I_o$	± 0.125	—	± 1.25	A
	AEW01CC24	$\pm I_o$	± 0.1	—	± 1.0	A
	AEW03AA48	$\pm I_o$	± 0.3	—	± 3.0	A
	AEW01BB48	$\pm I_o$	± 0.125	—	± 1.25	A
	AEW01CC48	$\pm I_o$	± 0.1	—	± 1.0	A
Output current-limiting setpoint ($V_o = 90\% V_{o,set}$ reference to the figure 19 — 24)	AEW03AA24	$\pm I_o$	—	3.7	4.3	A
	AEW01BB24	$\pm I_o$	—	1.76	2.0	A
	AEW01CC24	$\pm I_o$	—	1.4	1.6	A
	AEW03AA48	$\pm I_o$	—	3.9	4.5	A
	AEW01BB48	$\pm I_o$	—	1.6	2.0	A
	AEW01CC48	$\pm I_o$	—	1.26	1.6	A
short-circuit output current ($V_o = 0.25V$)	AEW03AA24	$\pm I_o$	—	4.2	—	A
	AEW01BB24	$\pm I_o$	—	2	—	A
	AEW01CC24	$\pm I_o$	—	1.8	—	A
	AEW03AA48	$\pm I_o$	—	3.6	—	A
	AEW01BB48	$\pm I_o$	—	1.8	—	A
	AEW01CC48	$\pm I_o$	—	1.7	—	A

Electrical Characteristic (continued)

List 5 Output characteristics (continued)

Parameter	Model	Symbol	Minimum	Typical	Maximum	Unit
Efficiency (rated input voltage, rated load, ambient temperature 25°C, figure 7—12)	AEW03AA24	η	82%	85%	—	—
	AEW01BB24	η	84%	88%	—	—
	AEW01CC24	η	84%	88%	—	—
	AEW03AA48	η	82%	85%	—	—
	AEW01BB48	η	84%	88%	—	—
	AEW01CC48	η	84%	88%	—	—
Dynamic response Conditions: $\Delta I_o/\Delta t=1A/10\mu s$ 1. load variable $I_o=50\%-75\%$ Voltage inrush Response time 2. load variable $I_o=50\%-25\%$ Voltage inrush Response time	All All	— —	— —	1% 100	5% 200	$V_{o,set}$ μs
Switching frequency	All	—	—	300	—	KHz
Output voltage adjustable range	All	—	90%	—	110%	$V_{o,set}$
Output over-voltage shutdown $+V_o \sim -V_o$	AEW03AA24	—	12	14	15	V
	AEW01BB24	—	27	30	34	V
	AEW01CC24	—	33.5	36	40	V
	AEW03AA48	—	12	14	15	V
	AEW01BB48	—	27	30	34	V
	AEW01CC48	—	33.5	36	40	V

Electrical Characteristic (continued)

List 6 Common characteristics

Parameter	Model	Minimum	Typical	Maximum	Unit
MTBF (according to Bellcore standard, I=80% rated current, operating temperature 40°C)	All	—	1,300,000	—	Hour (h)
Weight	All	—	—	120	grams (g)
Hand soldering time (pin temperature 425°C)	All	—	—	15	second (S)

List 7 On/OFF characteristics

Parameter	Model	Symbol	Minimum	Typical	Maximum	Unit
Start delay and rise time (80% rated load, ambient temperature 25°C)						
1. CNT is set on, input voltage sudden change (ON)(figure 5)	All	Tdelay	—	20	—	ms
2. In the available range of input voltage, CNT voltage sudden change (ON) (figure 6)	All	Tdelay	—	0.2	—	ms
3. Output voltage rise time	All	Trise	—	5	—	ms
4. Output voltage rush over	All	—	—	0	—	%Vo

List 8 Safety Characteristics

Parameter	Model	Symbol	Minimum	Typical	Maximum	Unit
Isolation voltage:						
Input - output	All	—	1500	—	—	Vdc
Input -case	All	—	1500	—	—	Vdc
Output - case	All	—	1500	—	—	Vdc
Isolation resistance	All	—	300	—	—	MΩ

Operating characteristic(continued)

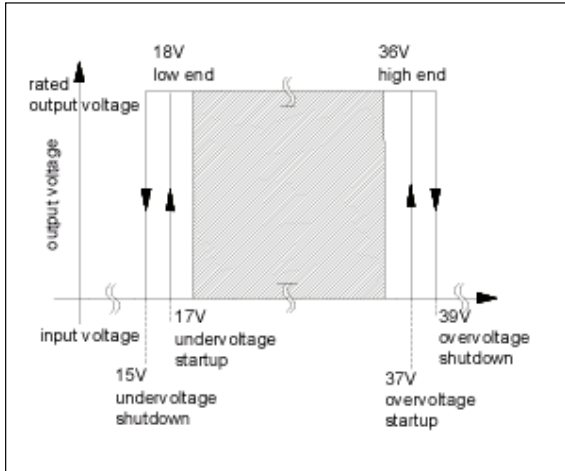

Fig. 1 24V input voltage range (typ.)

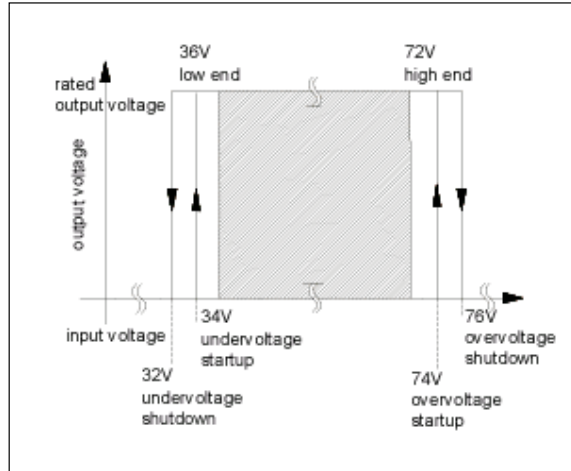

Fig. 2 48V input voltage range (typ.)

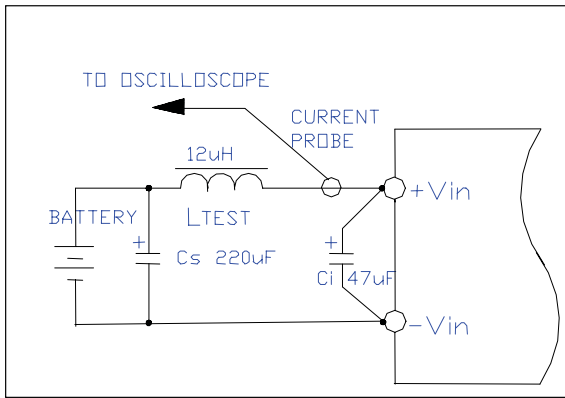

Fig. 3 Reflected noise current testing
With 12μH impedance, test point in the input line.

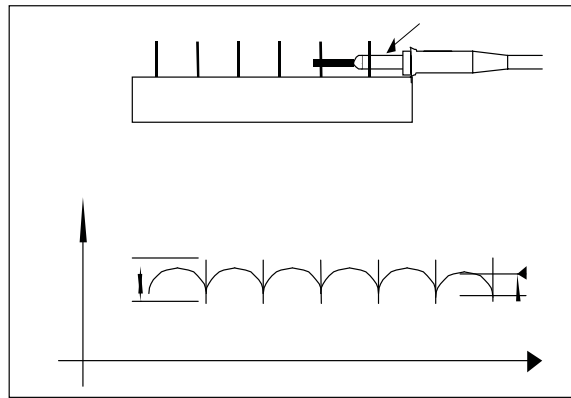

Fig. 4 Output ripple & noise testing method

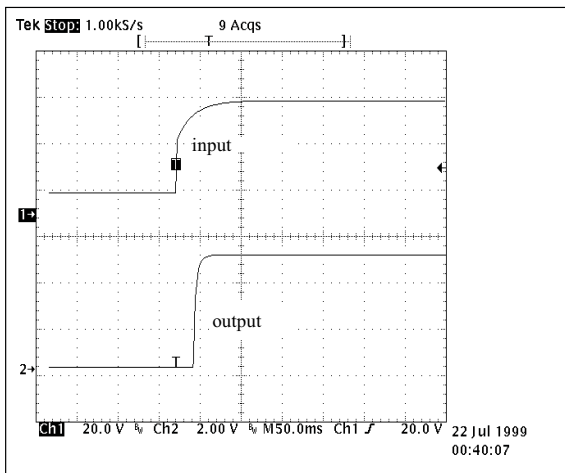

Fig. 5 Output voltage rise up curve
(Power on character, $I_o=80\%I_o,max$, $T_c=25^\circ C$)

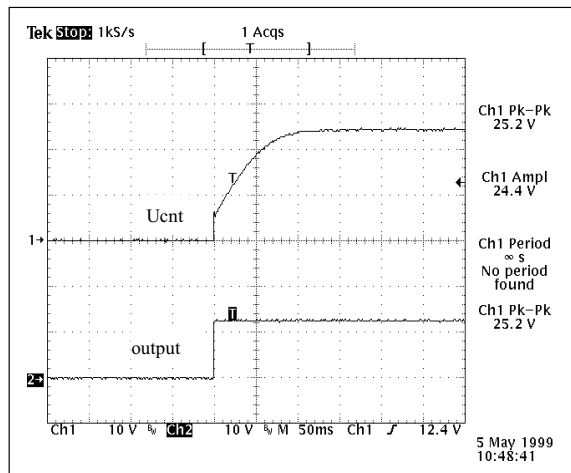

Fig. 6 output voltage rise up curve (rated voltage, current signal on CNT, $I_o=80\%I_o,max$, $T_c=25^\circ C$)

Operating characteristic(continued)

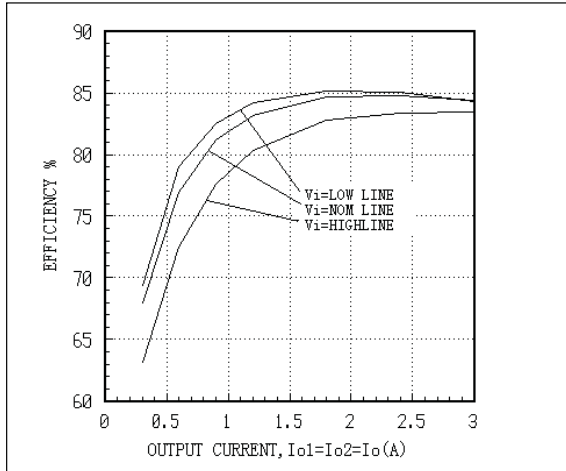

Fig. 7 AEW03AA24 Efficiency Curves

Tc=25°C

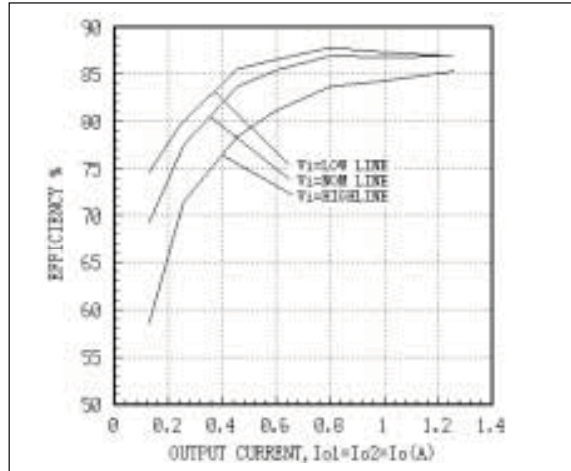

Fig. 8 AEW01BB24 Efficiency Curves

Tc=25°C

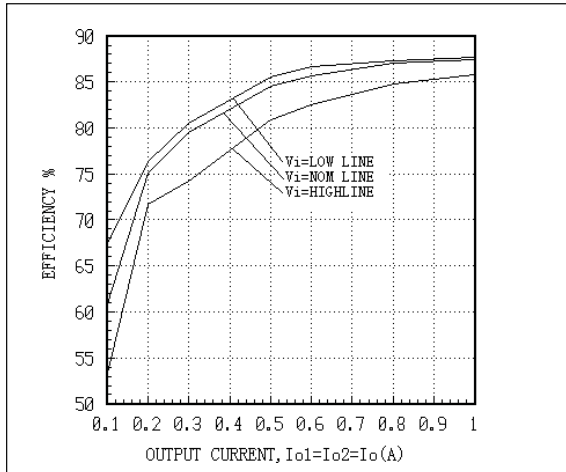

Fig. 9 AEW01CC24 Efficiency Curves

Tc=25°C

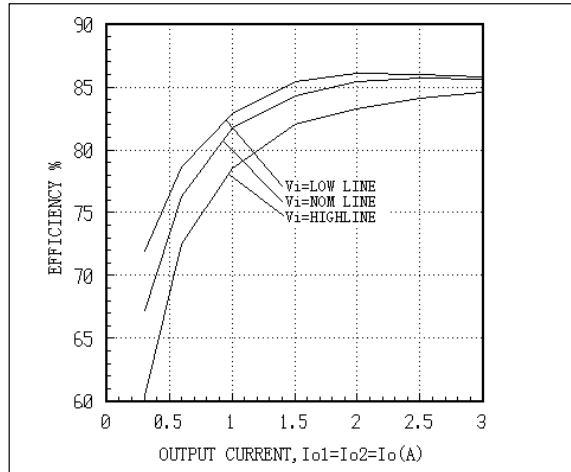

Fig. 10 AEW03AA48 Efficiency Curves

Tc=25°C

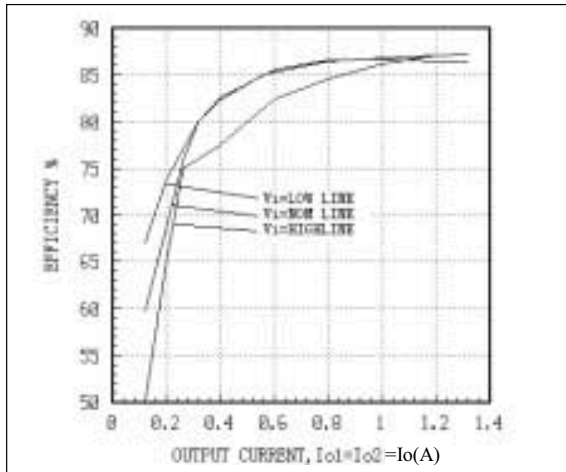

Fig. 11 AEW01BB48 Efficiency Curves

Tc=25°C

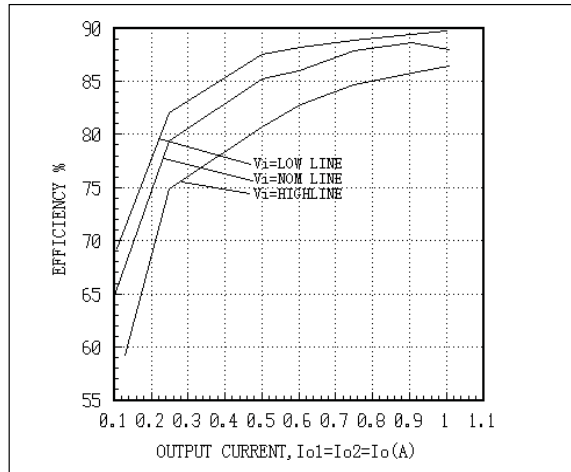

Fig. 12 AEW01CC48 Efficiency Curves

Tc=25°C

	USA	Europe	Asia
TEL:	1-760-930-4600	44-(0)1384-842-211	852-2437-9662
FAX:	1-760-930-0698	44-(0)1384-843-355	852-2402-4426



Operating characteristic(continued)

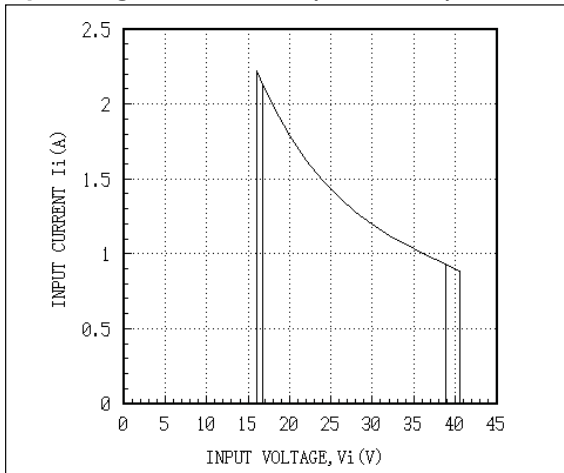

Fig. 13 AEW03AA24 Input Characteristic Curves
Tc=25°C

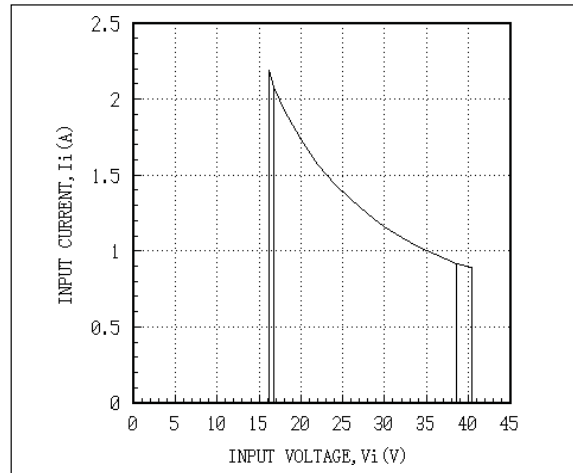

Fig. 14 AEW01BB24 Input Characteristic Curves
Tc=25°C

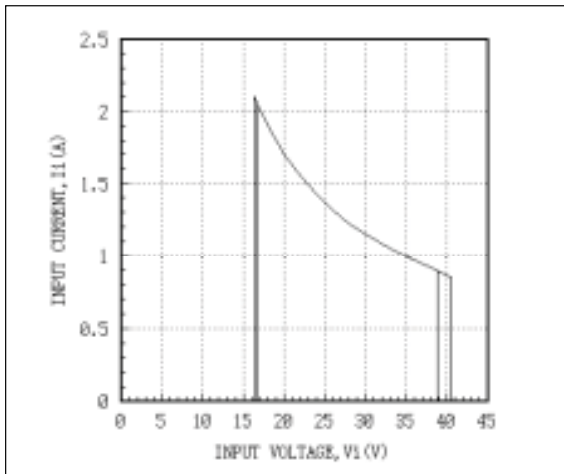

Fig. 15 AEW01CC24 Input Characteristic Curves
Tc=25°C

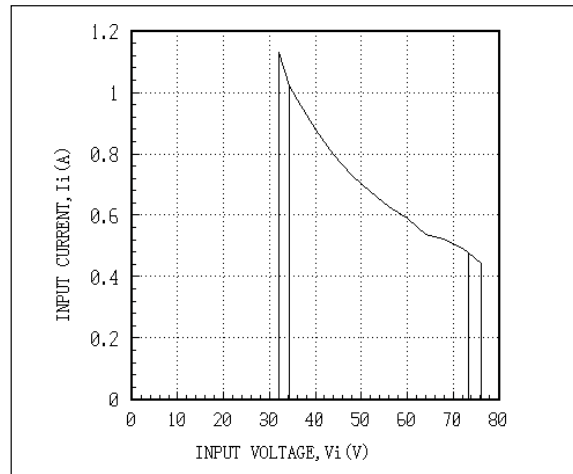

Fig. 16 AEW03AA48 Input Characteristic Curves
Tc=25°C

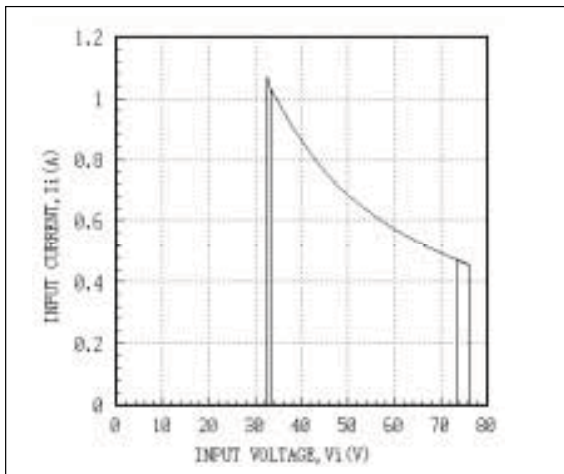

Fig. 17 AEW01BB48 Input Characteristic Curves
Tc=25°C

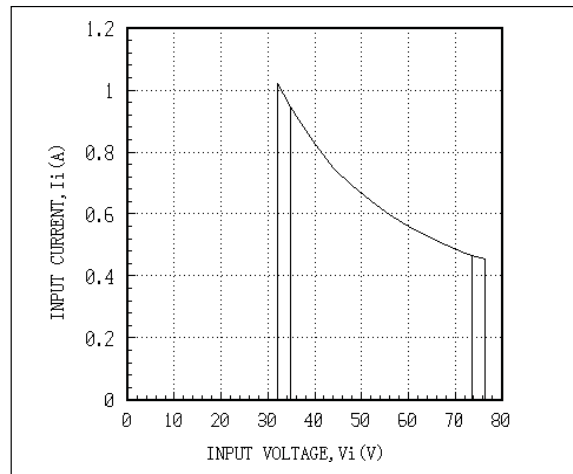

Fig. 18 AEW01CC48 Input Characteristic Curves
Tc=25°C

Operating characteristic(continued)

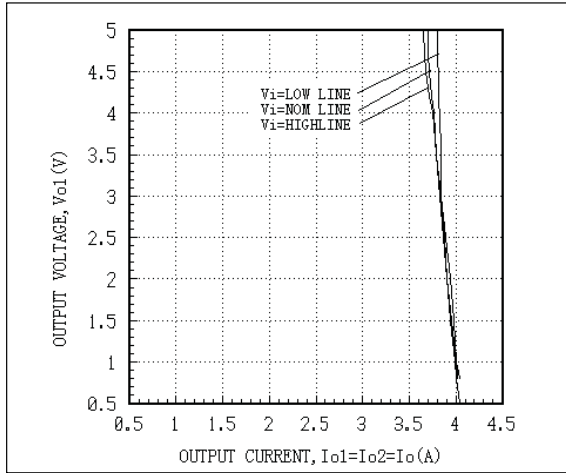

Fig. 19 AEW03AA24 Output Overcurrent Curves

Tc=25°C

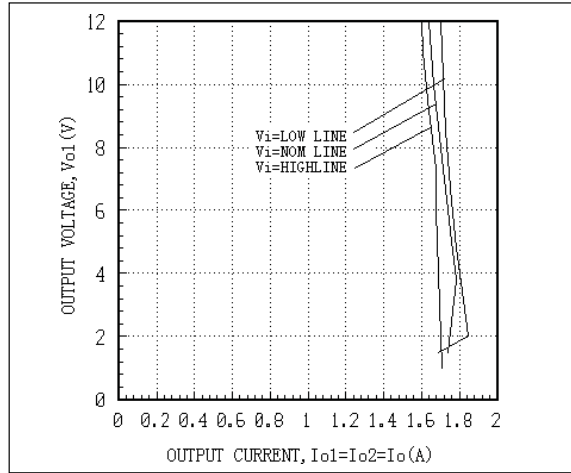

Fig. 20 AEW01BB24 Output Overcurrent Curves

Tc=25°C

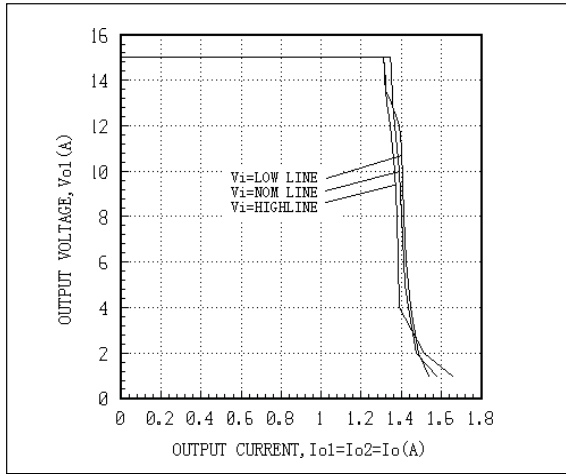

Fig. 21 AEW01CC24 Output Overcurrent Curves

Tc=25°C

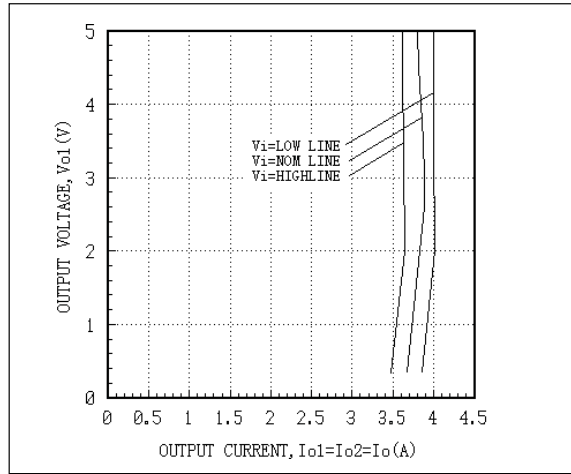

Fig. 22 AEW03AA48 Output Overcurrent Curves

Tc=25°C

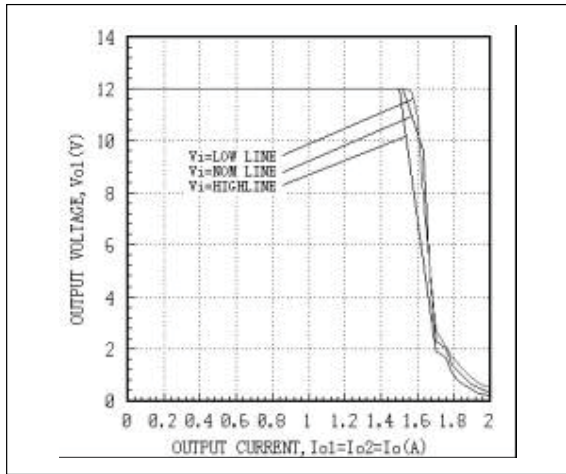

Fig. 23 AEW01BB48 Output Overcurrent Curves

Tc=25°C

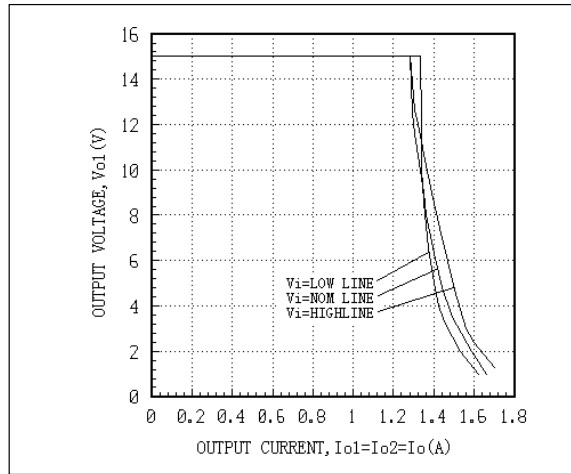

Fig. 24 AEW01CC48 Output Overcurrent Curves

Tc=25°C

Operating characteristic(continued)

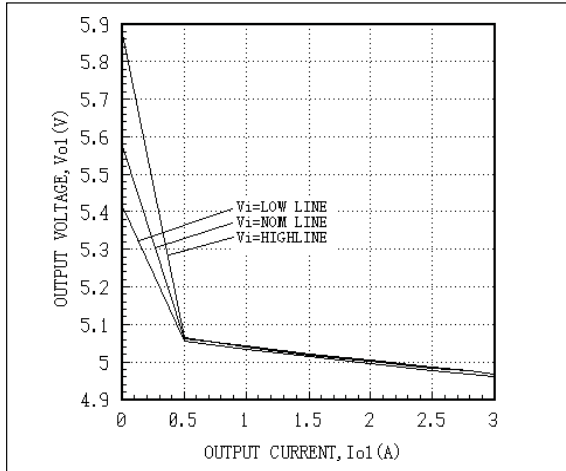

Fig. 25 AEW03AA24 Load Regulation Curves
 $Io2=10\%Io$ constant, $Io1$ variable, $Tc=25^{\circ}C$

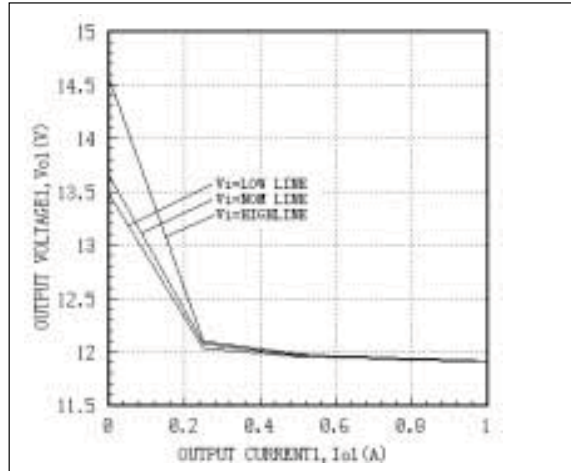

Fig. 26 AEW01BB24 Load Regulation Curves
 $Io2=10\%Io$ constant, $Io1$ variable, $Tc=25^{\circ}C$

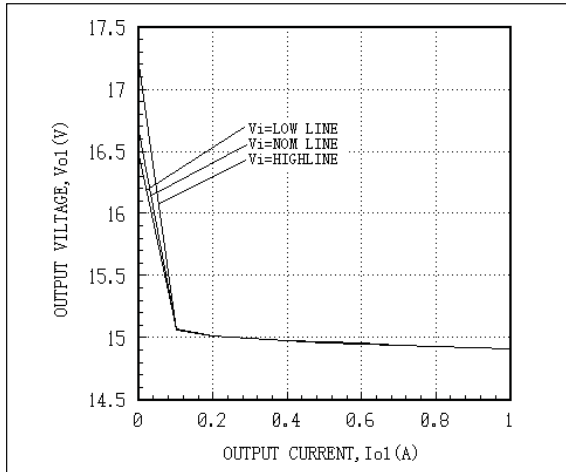

Fig. 27 AEW01CC24 Load Regulation Curves
 $Io2=10\%Io$ constant, $Io1$ variable, $Tc=25^{\circ}C$

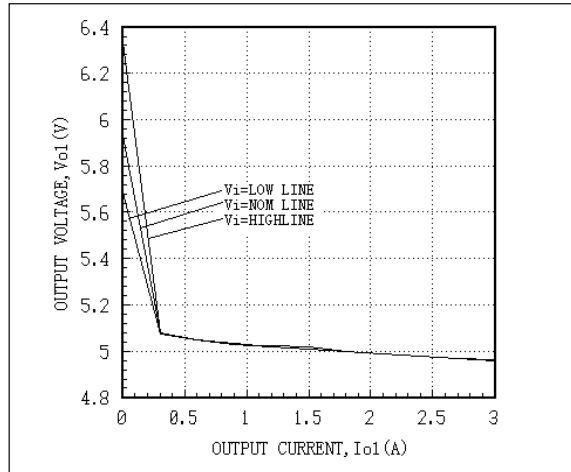

Fig. 28 AEW03AA48 Load Regulation Curves
 $Io2=10\%Io$ constant, $Io1$ variable, $Tc=25^{\circ}C$

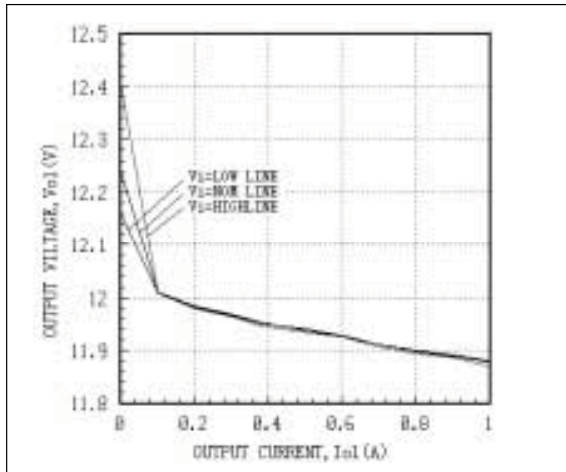

Fig. 29 AEW01BB48 Load Regulation Curves
 $Io2=10\%Io$ constant, $Io1$ variable, $Tc=25^{\circ}C$

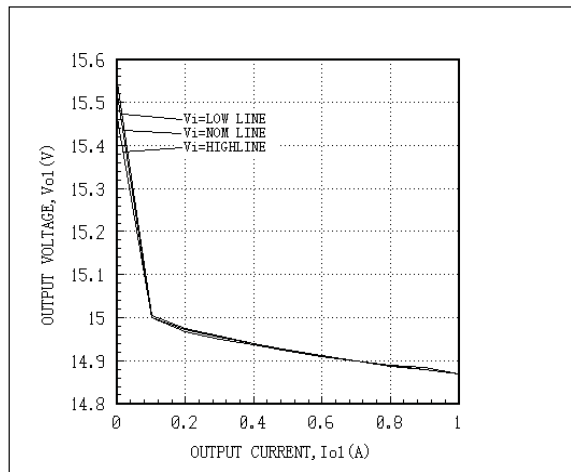

Fig. 30 AEW01CC48 Load Regulation Curves
 $Io2=10\%Io$ constant, $Io1$ variable, $Tc=25^{\circ}C$

Operating characteristic(continued)

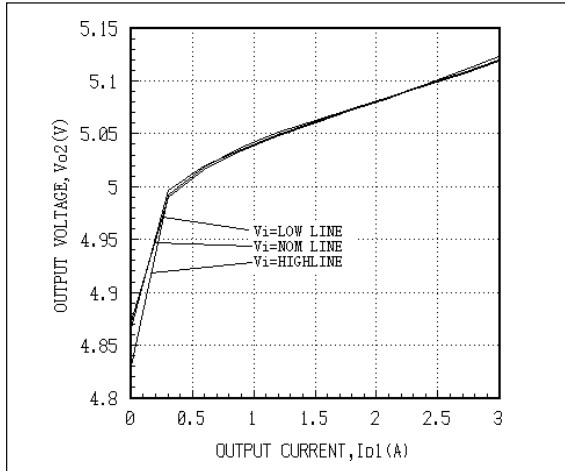

Fig. 31 AEW03AA24 Cross Regulation
Io2=10%Io constant, Io1 variable, Tc=25°C

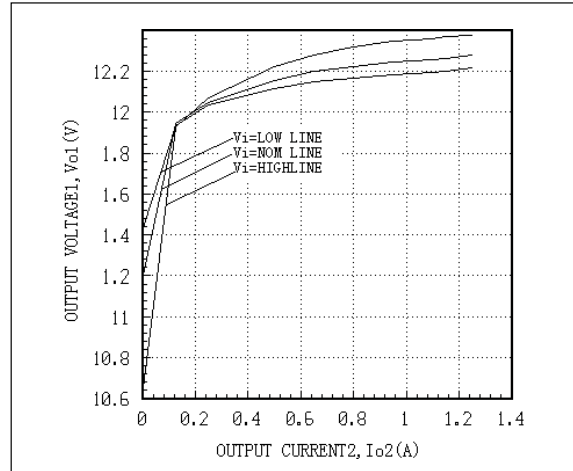

Fig. 32 AEW01BB24 Cross Regulation
Io2=10%Io constant, Io1 variable, Tc=25°C

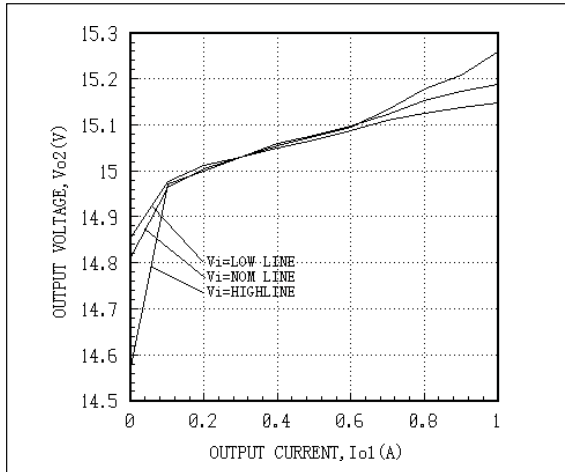

Fig. 33 AEW01CC24 Cross Regulation
Io2=10%Io constant, Io1 variable, Tc=25°C

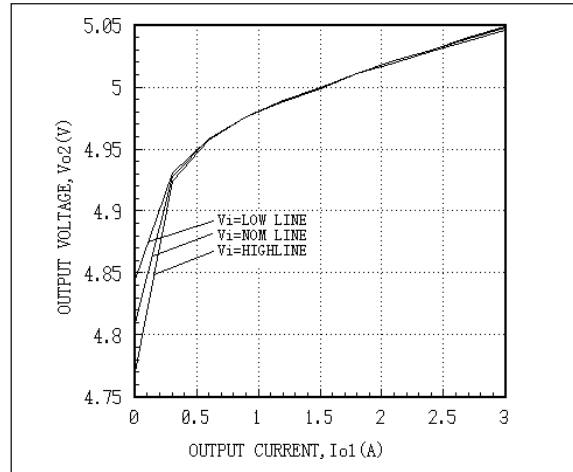

Fig. 34 AEW03AA48 Cross Regulation
Io2=10%Io constant, Io1 variable, Tc=25°C

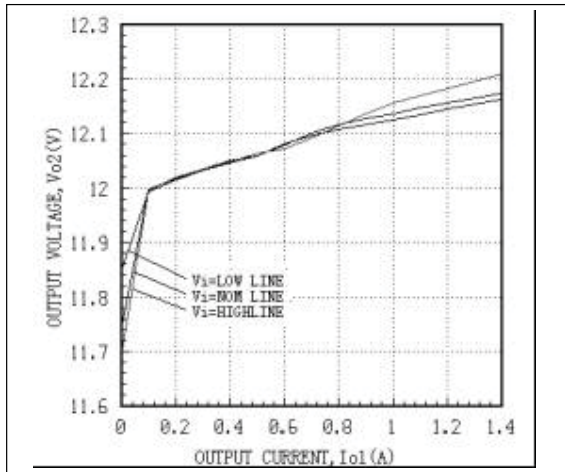

Fig. 35 AEW01BB48 Cross Regulation
Io2=10%Io constant, Io1 variable, Tc=25°C

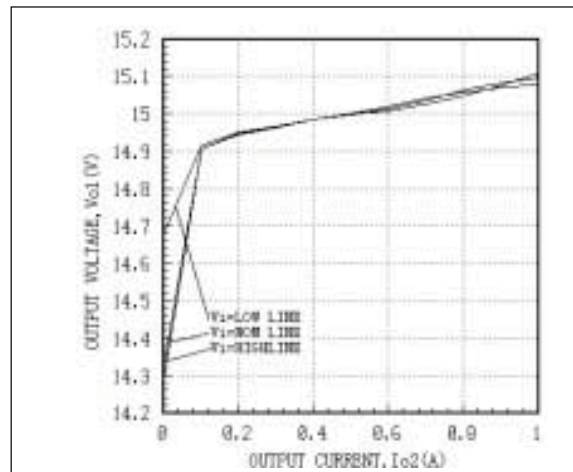

Fig. 36 AEW01CC48 Cross Regulation
Io2=10%Io constant, Io1 variable, Tc=25°C

Operating characteristic(continued)

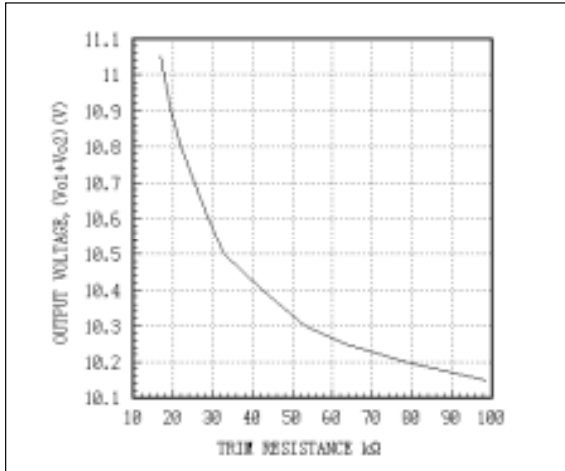

Fig. 37 AEW 5V Dual Output Trim Up Curve
Rated input, rated load, Tc=25°C

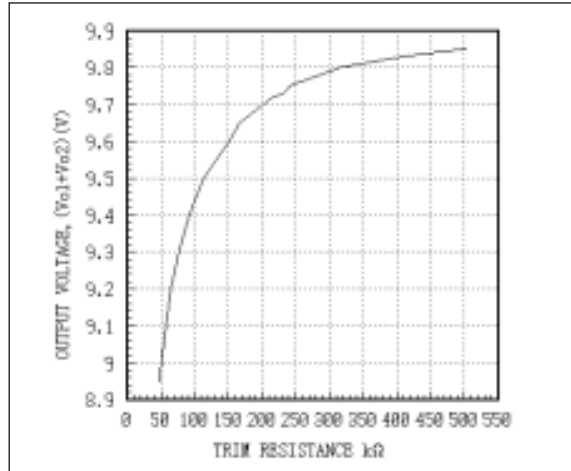

Fig. 38 AEW 5V Dual Output Trim Down Curve
Rated input, rated load, Tc=25°C

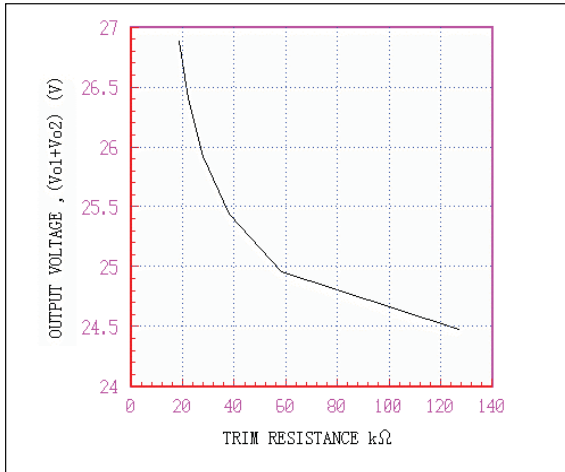

Fig. 39 AEW 12V Dual Output Trim Up Curve
Rated input, rated load, Tc=25°C

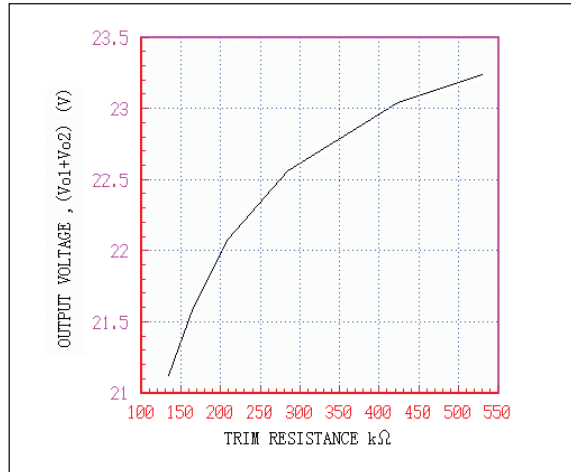

Fig. 40 AEW 12V Dual Output Trim Down Curve
Rated input, rated load, Tc=25°C

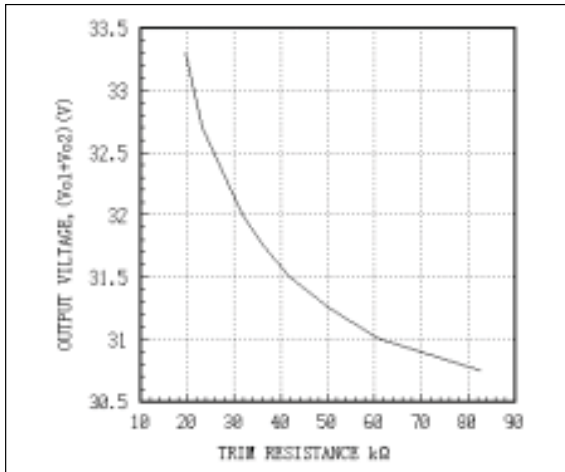

Fig. 41 AEW 15V Dual Output Trim Up Curve
Rated input, rated load, Tc=25°C

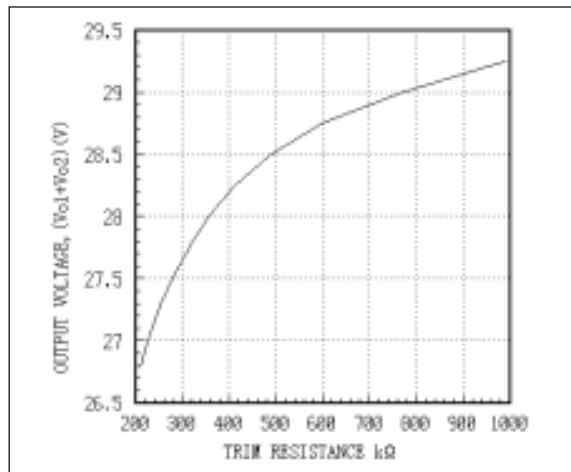

Fig. 42 AEW 15V Dual Output Trim Down Curve
Rated input, rated load, Tc=25°C

Operating characteristic(continued)

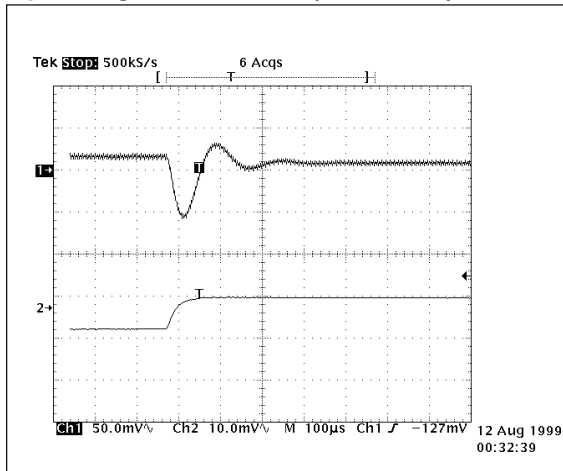

Fig. 43 Dynamic Response
50%-75% load variable, Tc=25°C

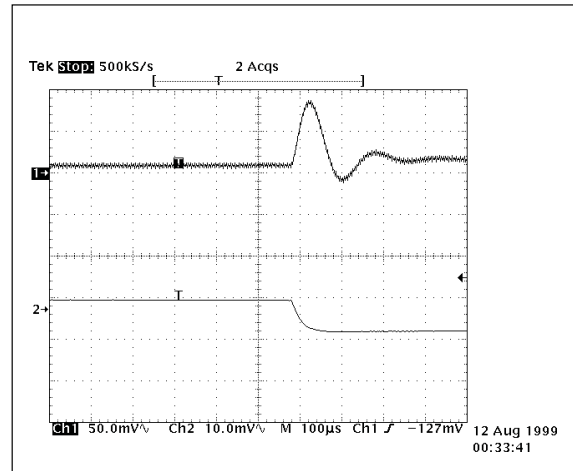

Fig. 44 Dynamic Response
50%-75% load variable, Tc=25°C



AEW Triple Output Series

30W DC-DC Converter

Feature:

- Two wide input voltage range
- Input over-/under-voltage protection
- Trim function
- Output over-voltage shutdown
- Output over-current protection
- Load shortcircuit protection
- High efficiency, density and reliability
- Low profile (Typical height: 12.7mm)
- UL CSA TUV approved
- Meet with FCC Class A

Size: 76.2%~~63.5~~12.7(3.0"%~~2.5~~0.5")

Application:

- * Data collection
- * Program controlled equipment
- * Instruments
- * Communication system
- * Separately power supply system

Introduction:

AEW series adopt 3"x2.5" standard industrial encapsulation and pin with height less than 0.5", providing 2-output and 3-output.

AEW 30W 2-output and AEW 30W 3-output products are compact, high performance DC/DC converters. They adopt state-of-the-art SMT and sealing structure, feature high power density, small weight, and are suitable for applications requiring isolated stabilized voltage. They provide +-5V, +-12V, +-15V 2-output or 5V/+-12V, 5V/+-15V 3-output. The input voltage can be 24VDC or 48VDC.

With low output ripple and noise, highly stabilized voltage accuracy, high efficiency and reliability, the AEW 2-output and AEW 3-output series are suitable for by-board distributed power supply system.

	USA	Europe	Asia
TEL:	1-760-930-4600	44-(0)1384-842-211	852-2437-9662
FAX:	1-760-930-0698	44-(0)1384-843-355	852-2402-4426



Table 1 AEW triple output products list

Model	Input voltage (V)	Output voltage (V) / Output current(A)	Code
◆ <i>AEW05ABB24</i>	18-36	5V/5A/±12V/1A	02280355
◆ <i>AEW05ACC24</i>	18-36	5V/5A/±15V/0.8A	02280357
◆ <i>AEW05ABB48</i>	36-72	5V/5A/±12V/1A	02280263
◆ <i>AEW05ACC48</i>	36-72	5V/5A/±15V/0.8A	02280356

Absolute maximum value:

The following list is the maximum stress that the module can endure. If the module works under the condition for a long time, it may short the lifetime and have bad effect on its reliability. If the environmental stress exceeds the absolute maximum value listed below, the module may be damaged forever.

List 2 Extreme limit parameters

Parameters	Model	Minimum	Maximum	Unit	Note
Input voltage (+Vin~-Vin)	Rated 24V	—	42	Vdc	Continuously
		—	50	Vdc	Instant < 100ms
	Rated 48V	—	82	Vdc	Continuously
		—	100	Vdc	Instant < 100ms
CNT voltage (CNT~-Vin)	Rated 24V	—	42	Vdc	Continuously
	Rated 48V	—	82	Vdc	Continuously
Isolated voltage Input-output	All	—	2000	Vdc	
Operating ambient temperature	All	-25	+70	°C	Derating at 55°C
Storage temperature	All	-40	+105	°C	
Pin soldering temperature	All	—	260	°C	Wave solder < 12S

Principle

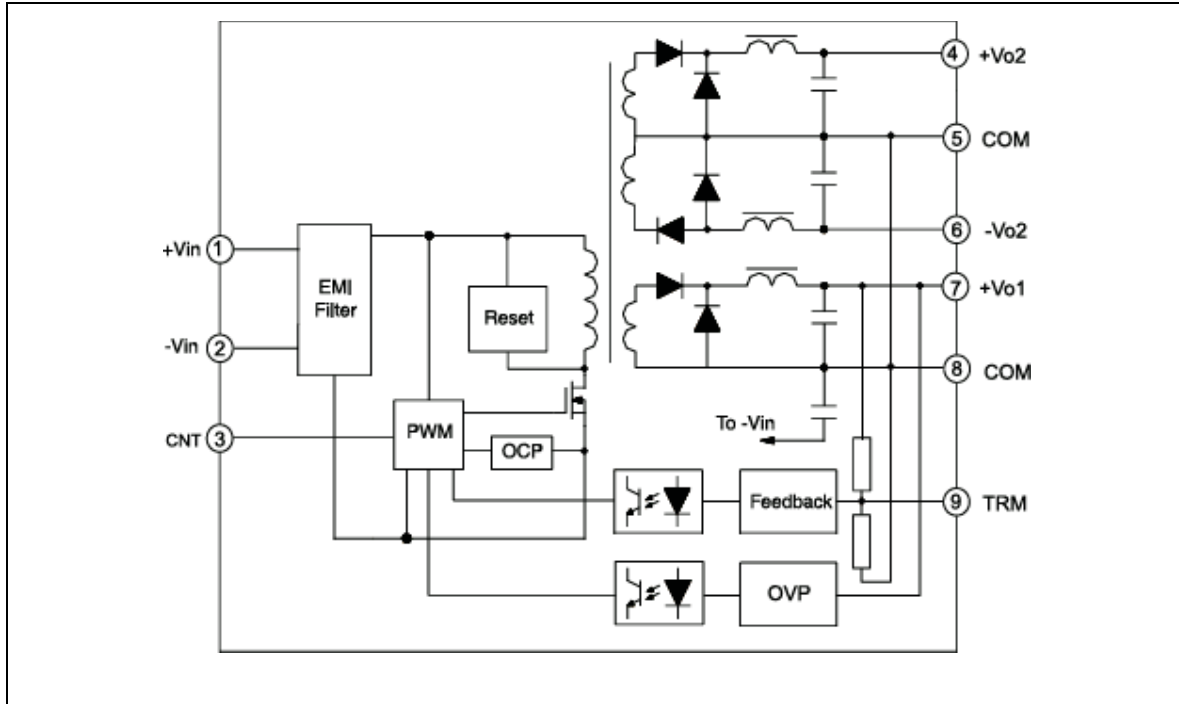

Outline size

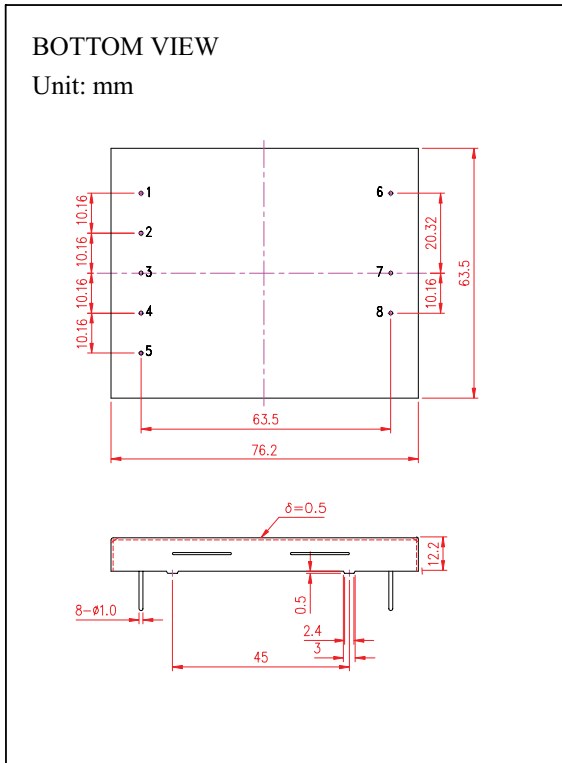

Pin definition

Pin	Symbol	Function
1	TRM	Trim
2	+Vo1	Output1 +
3	COM	Output common ground
4	+Vo2	Output2 +
5	-Vo2	Output2 -
6	CNT	Remote control
7	+Vin	Input +
8	-Vin	Input -

Electrical Characteristic (continued)

List 3 Input characteristics

Parameter	Model	Symbol	Minimum	Typical	Maximum	Unit
Input voltage range	Rated 24V	V _{in}	18	24	36	Vdc
	Rated 48V	V _{in}	36	48	72	Vdc
Maximum input current (the lowest input voltage, rated output)	AEW05ABB24	I _{in}	—	—	2.06	A
	AEW05ACC24	I _{in}	—	—	2.06	A
	AEW05ABB48	I _{in}	—	—	1.02	A
	AEW05ACC48	I _{in}	—	—	1.02	A
Input under-voltage shutdown	Rated 24V	—	14	15.5	18	Vdc
	Rated 48V	—	30	33	36	Vdc
Input over-voltage shutdown	Rated 24V	—	36	40	42	Vdc
	Rated 48V	—	72	76	82	Vdc
Input reflected current (5Hz-20MHz, 12μH impedance, TA=25°C reference AEW dual output figure 3)	All	—	—	5	20	mAp-p

Note: there is no fuse inside the power module. Recommend adding an external fuse in the input of the module.

A common fuse can be selected, the value can refer to the maximum current in the list 3.

List 4 Remote ON/OFF

Parameter	Model	Symbol	Minimum	Typical	Maximum	Unit
Remote ON/OFF logic	All	CNT	CNT in the midair, output ON CNT connects with -VIN, output OFF			—

Electrical Characteristic (continued)

List 5 Output characteristics

Parameter	Model	Symbol	Minimum	Typical	Maximum	Unit
Output setpoint voltage Condition: 1. 25°C ambient temperature, 2. rated input, 3. 20% load	AEW05ABB24	Vo1,set	+4.95	+5.0	+5.05	Vdc
		Vo2,set	+11.4	+12.0	+12.6	Vdc
		-Vo2,set	-11.4	-12.0	-12.6	Vdc
	AEW05ACC24	Vo1,set	+4.95	+5.0	+5.05	Vdc
		Vo2,set	+14.25	+15.0	+15.75	Vdc
		-Vo2,set	-14.25	-15.0	-15.75	Vdc
	AEW05ABB48	Vo1,set	+4.95	+5.0	+5.05	Vdc
		Vo2,set	+11.4	+12.0	+12.6	Vdc
		-Vo2,set	-11.4	-12.0	-12.6	Vdc
	AEW05ACC48	Vo1,set	+4.95	+5.0	+5.05	Vdc
		Vo2,set	+14.25	+15.0	+15.75	Vdc
		-Vo2,set	-14.25	-15.0	-15.75	Vdc
Output voltage Conditions: 1. Full input range, output range and ambient temperature range. 2. 20% — 100% load.	AEW05ABB24	Vo1	+4.83	+5.0	+5.17	Vdc
		Vo2	+11.04	+12.0	+12.96	Vdc
		-Vo2	-11.04	-12.0	-12.96	Vdc
	AEW05ACC24	Vo1	+4.83	+5.0	+5.17	Vdc
		Vo2	+13.8	+15.0	+16.2	Vdc
		-Vo2	-13.8	-15.0	-16.2	Vdc
	AEW05ABB48	Vo1	+4.83	+5.0	+5.17	Vdc
		Vo2	+11.04	+12.0	+12.96	Vdc
		-Vo2	-11.04	-12.0	-12.96	Vdc
	AEW05ACC48	Vo1	+4.83	+5.0	+5.17	Vdc
		Vo2	+13.8	+15.0	+16.2	Vdc
		-Vo2	-13.8	-15.0	-16.2	Vdc
Line regulation	All	Vo1	—	0.01	0.2	%
Low—high		Vo2	—	0.5	2	%
Io2=—Io2		-Vo2	—	0.5	2	%

Electrical Characteristic (continued)

List 5 Output characteristics

Parameter	Model	Symbol	Minimum	Typical	Maximum	Unit
Load regulation 20%—100% rated load (Io2= -Io2)	All	Vo1	—	0.01	0.5	%
		Vo2	—	2.5	8	%
		-Vo2	—	2.5	8	%
Cross regulation Io1 variable (Io2= -Io2 constantly)	All	Vo2	—	3.5	8	%
		-Vo2	—	3.5	8	%
Temperature coefficiency	All	Tcoeff	—	—	0.02	%/°C
Output ripple typical value (testing method reference to AV30-D series figure 4)	AEW05ABB24	Vo1	—	6	25	mVrms
		Vo2	—	10	30	mVrms
		-Vo2	—	10	30	mVrms
	AEW05ACC24	Vo1	—	8	25	mVrms
		Vo2	—	10	30	mVrms
		-Vo2	—	10	30	mVrms
	AEW05ABB48	Vo1	—	10	25	mVrms
		Vo2	—	10	30	mVrms
		-Vo2	—	12	30	mVrms
	AEW05ACC48	Vo1	—	10	25	mVrms
		Vo2	—	10	30	mVrms
		-Vo2	—	10	30	mVrms
Output ripple&noise peak-peak value (testing method reference to AV30-D figure 4)	AEW05ABB24	Vo1	—	85	100	mVp-p
		Vo2	—	90	150	mVp-p
		-Vo2	—	90	150	mVp-p
	AEW05ACC24	Vo1	—	40	100	mVp-p
		Vo2	—	50	150	mVp-p
		-Vo2	—	60	150	mVp-p

Electrical Characteristic (continued)

List 5 Output characteristics

Parameter	Model	Symbol	Minimum	Typical	Maximum	Unit
Output ripple&noise peak-peak value (testing method reference to AV30-D figure 4)	AEW05ABB48	Vo1	—	75	100	mVp-p
		Vo2	—	50	150	mVp-p
		-Vo2	—	85	150	mVp-p
	AEW05ACC48	Vo1	—	45	100	mVp-p
		Vo2	—	40	150	mVp-p
		-Vo2	—	50	150	mVp-p
Output current (triple output, Io<Io,min. During operation, the total power of three outputs should not exceed 30W)	AEW05ABB24	Io1	1	—	5	A
		Io2	0.2	—	1	A
		-Io2	0.2	—	1	A
	AEW05ACC24	Io1	1	—	5	A
		Io2	0.16	—	0.8	A
		-Io2	0.16	—	0.8	A
	AEW05ABB48	Io1	1	—	5	A
		Io2	0.2	—	1	A
		-Io2	0.2	—	1	A
	AEW05ACC48	Io1	1	—	5	A
		Io2	0.16	—	0.8	A
		-Io2	0.16	—	0.8	A
Output current-limiting setpoint	AEW05ABB24	Io1 (Io2=-Io2=0.2A)	—	6.7	7.8	A
		Io2=-Io2 (Io1=1A)	—	1.38	—	A
	AEW05ABB24	Io1 (Io2=-Io2=0.16A)	—	6.8	7.8	A
		Io2=-Io2 (Io1=1A)	—	1.18	—	A

Electrical Characteristic (continued)

List 5 Output characteristics

Parameter	Model	Symbol	Minimum	Typical	Maximum	Unit
Output current-limiting setpoint	AEW05ABB48	Io1 (Io2= -Io2=0.2A)	—	6.8	7.8	A
		Io2=-Io2 (Io1=1A)	—	1.38	—	A
	AEW05ABB48	Io1 (Io2=-Io2=0.16A)	—	6.9	7.8	A
		Io2=-Io2 (Io1=1A)	—	1.18	—	A
Efficiency (rated input voltage, Io1=3A,Io2=-Io2=0.6A, ambient temperature 25°C)	AEW05ABB24	η	81%	84%	—	
	AEW05ACC24	η	82%	85%	—	
	AEW05ABB48	η	81%	84%	—	
	AEW05ACC48	η	82%	85%	—	
Dynamic response Conditions: $\Delta Io/\Delta t=1A/10\mu s$ 1.load variable Io1=50%-75%, Io2=-Io2=Io,min Voltage drop Response time 2.load variable Io1=50%-25%, Io2=-Io2=Io,min Voltage inrush Response time	All	—	—	1%	5%	Vo,set
		—	—	100	200	μs
	All	—	—	1%	5%	Vo,set
		—	—	105	200	μs
	All	—	—	300	—	KHz
	All	—	90%	—	110%	Vo.nom
Output over-voltage shutdown (Vo1)	AEW05ABB24	—	5.8	6.8	7.5	V
	AEW05ACC24	—	5.8	6.8	7.5	V
	AEW05ABB48	—	5.8	6.8	7.5	V
	AEW05ACC48	—	5.8	6.8	7.5	V

Electrical Characteristic (continued)

List 6 Common characteristics

Parameter	Model	Minimum	Typical	Maximum	Unit
MTBF (according to Bellcore standard, I=80% rated current, operating temperature 40°C)	All	—	1,200,000	—	Hour (h)
Weight	All	—	—	120	Gram (g)
Hand soldering time (pin temperature 425°C)	All	—	—	5	second (S)

List 7 On/OFF characteristics

Parameter	Model	Symbol	Minimum	Typical	Maximum	Unit
Start delay and rise time (80% rated load, ambient temperature 25°C)						
1. CNT is set on, input voltage sudden change (ON)(figure 5)	All	Tdelay	—	15	—	ms
2. In the available range of input voltage, CNT voltage sudden change (ON) (figure 6)	All	Tdelay	—	10	—	ms
3. Output voltage rise time	All	Trise	—	5	—	ms
4. Output voltage rush over	All	—	—	0	—	%Vo

List 8 Safety Characteristics

Parameter	Model	Symbol	Minimum	Typical	Maximum	Unit
Isolation voltage:						
Input - output	All	—	1500	—	—	Vdc
Input -case	All	—	1500	—	—	Vdc
Output - case	All	—	1500	—	—	Vdc
Isolation resistance	All	—	300	—	—	MΩ

Operating characteristic (continued)

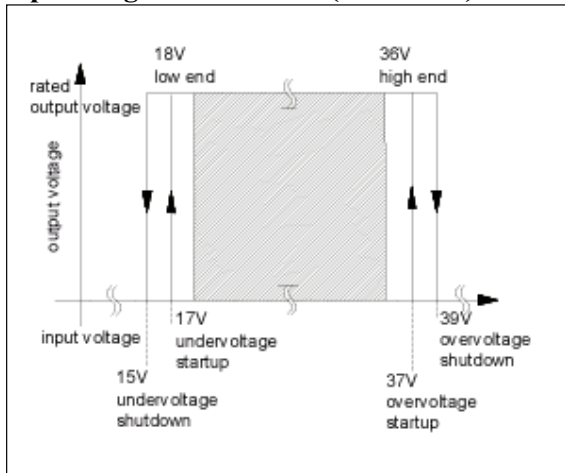

Fig. 1 24V input voltage range (typ.)

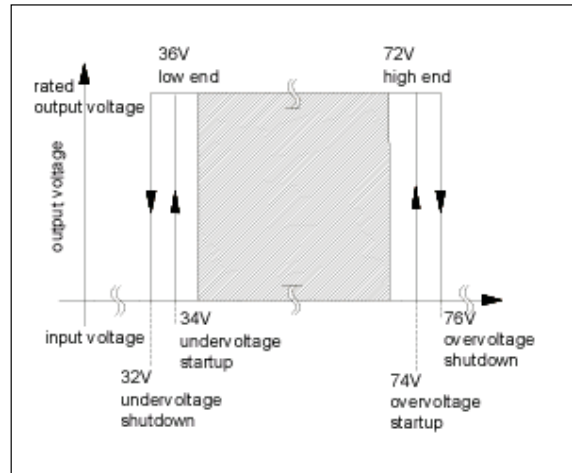

Fig. 2 48V input voltage range (typ.)

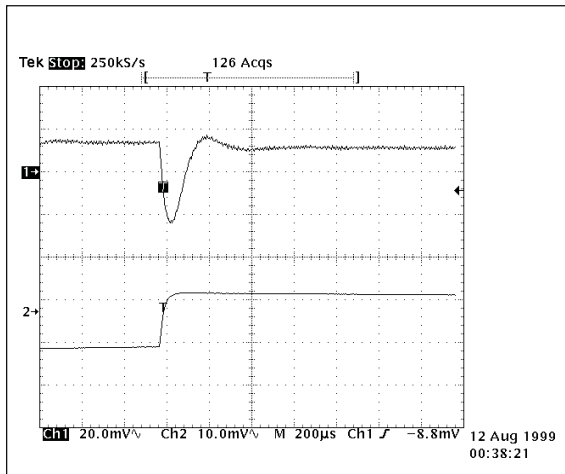

Fig. 3 Dynamic Response

50%-75% Io1 load variable, Tc=25°C

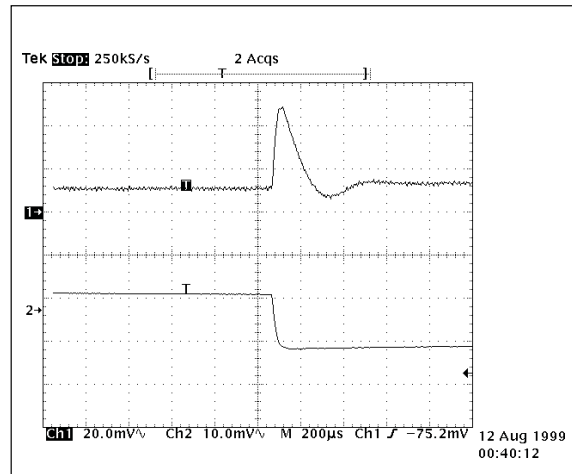

Fig. 4 Dynamic Response

50%-75% Io1 load variable, Tc=25°C

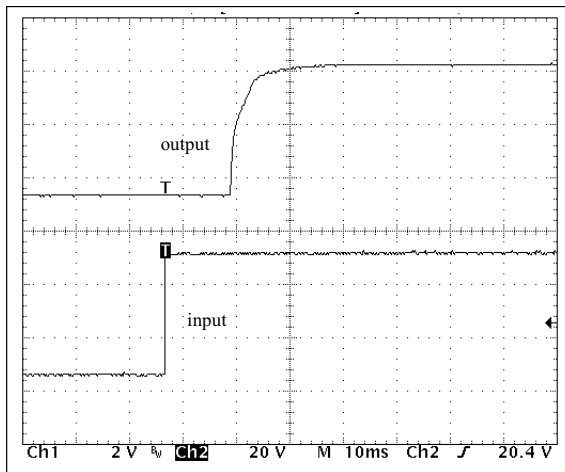

Fig. 5 Output voltage rise up (AV30-48T0512 typ.)
(Power on character, Io=80%Io,max, Tc=25°C)

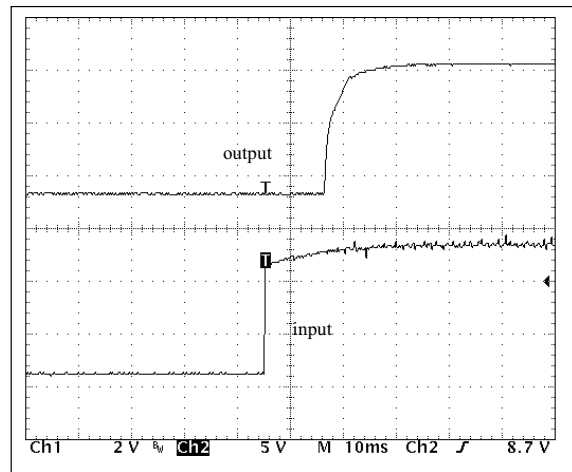

Fig. 6 Output voltage rise up (AV30-48T0512 typ.)
current signal on CNT, Io=80%Io,max, Tc=25°C)

Operating characteristic (continued)

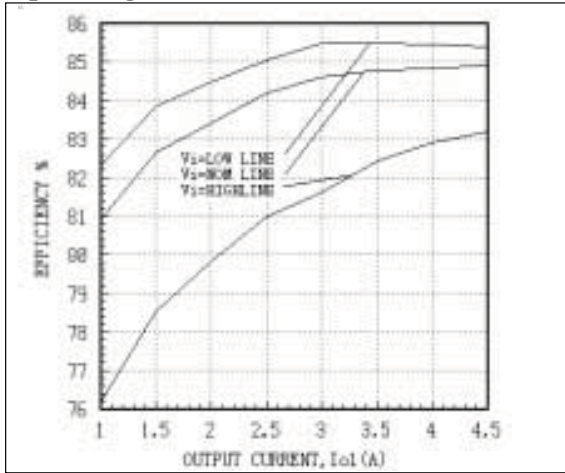

Fig. 7 AEW05ABB24 Efficiency Curves
 $I_{o2} = -I_{o2} = I_o$, min $T_c = 25^\circ\text{C}$

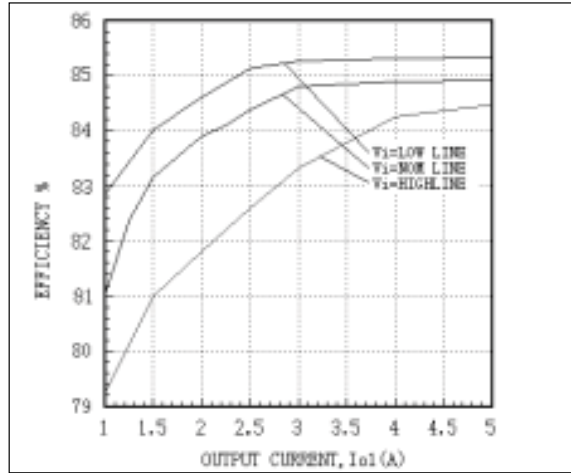

Fig. 8 AEW05ACC24 Efficiency Curves
 $I_{o2} = -I_{o2} = I_o$, min $T_c = 25^\circ\text{C}$

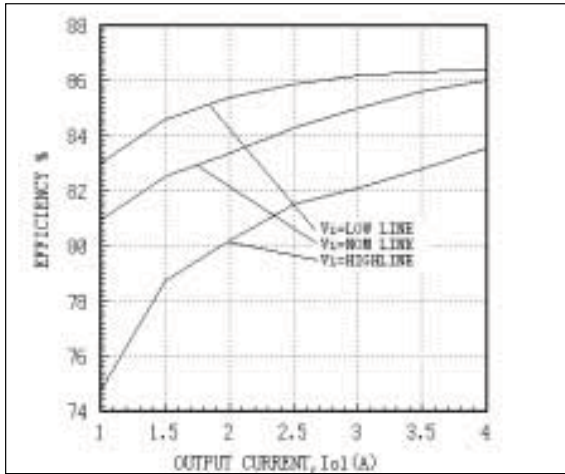

Fig. 9 AEW05ABB48 Efficiency Curves
 $I_{o2} = -I_{o2} = I_o$, min $T_c = 25^\circ\text{C}$

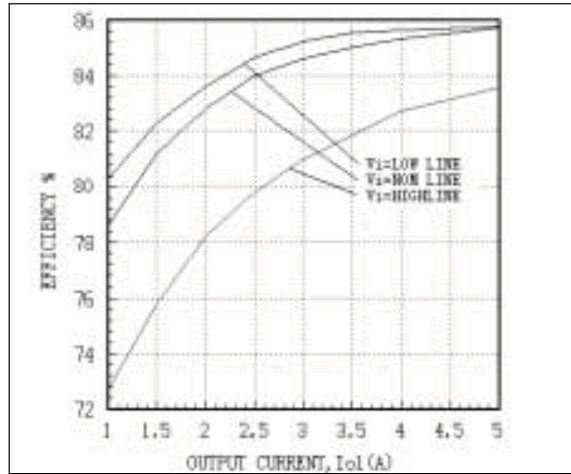

Fig. 10 AEW05ACC48 Efficiency Curves
 $I_{o2} = -I_{o2} = I_o$, min $T_c = 25^\circ\text{C}$

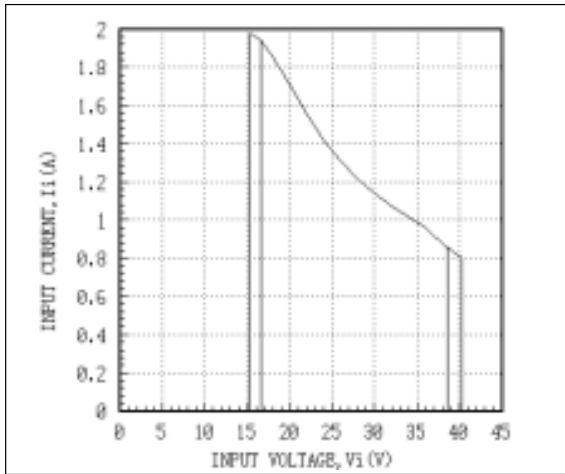

Fig. 11 AEW05ABB24 Input Characteristic Curves
 $T_c = 25^\circ\text{C}$

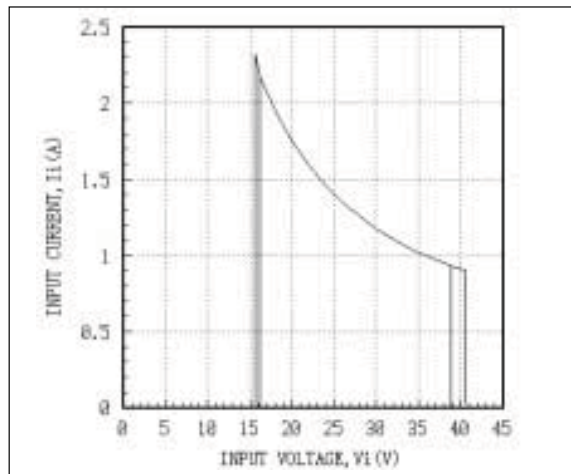

Fig. 12 AEW05ACC24 Input Characteristic Curves
 $T_c = 25^\circ\text{C}$

Operating characteristic (continued)

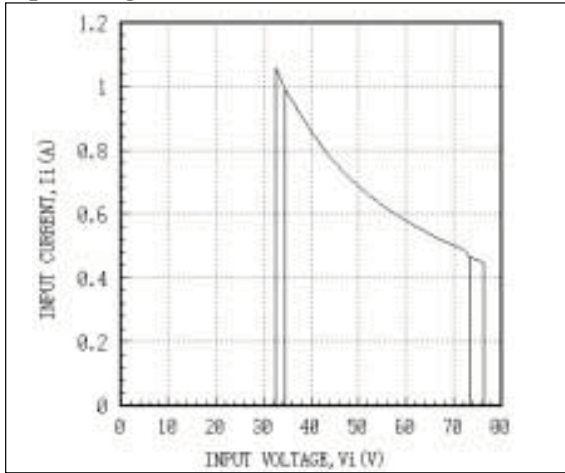

Fig. 13 AEW05ABB48 Input Characteristic Curves

Tc=25°C

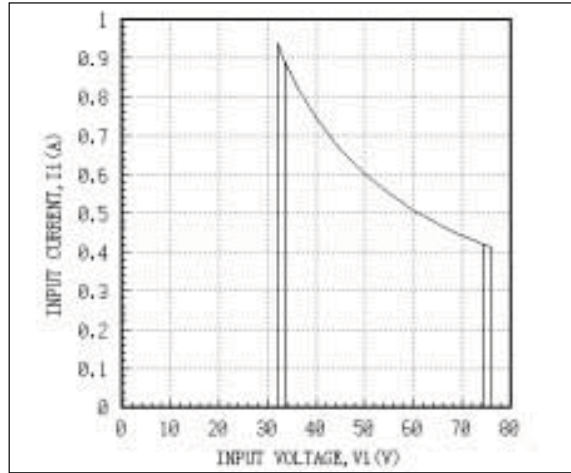

Fig. 14 AEW05ACC48 Input Characteristic Curves

Tc=25°C

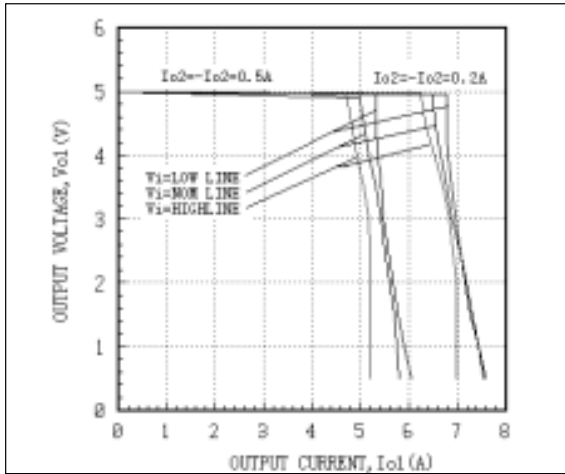

Fig. 15 AEW05ABB24 Main Output Character Curves

Tc=25°C

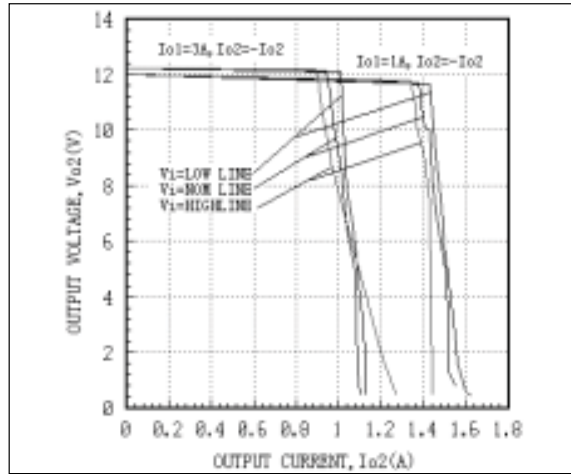

Fig. 16 AEW05ACC24 Auxiliary output Character Curves

Tc=25°C

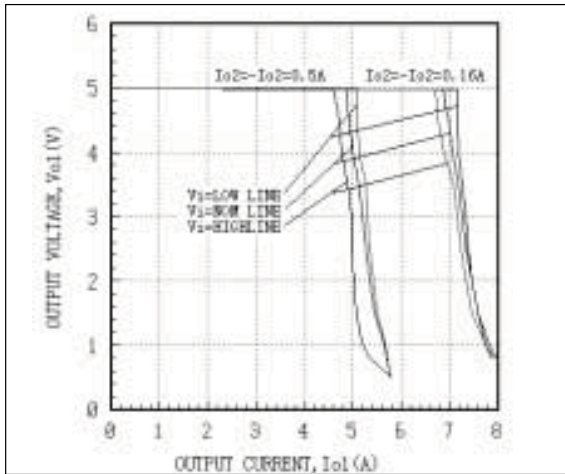

Fig. 17 AEW05ABB48 Main Output Character Curves

Tc=25°C

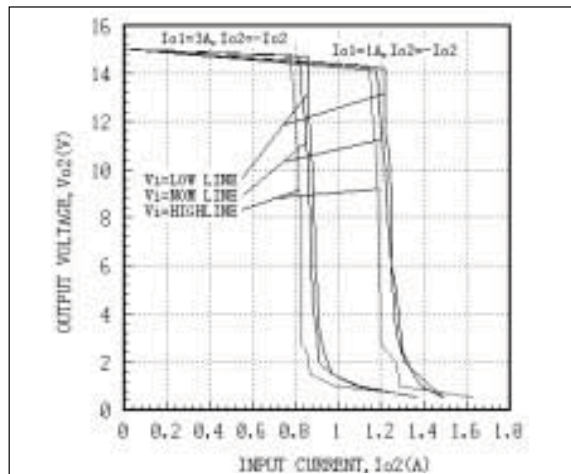

Fig. 18 AEW05ACC48 Auxiliary output Character Curves

Tc=25°C

	USA	Europe	Asia
TEL:	1-760-930-4600	44-(0)1384-842-211	852-2437-9662
FAX:	1-760-930-0698	44-(0)1384-843-355	852-2402-4426



Operating characteristic (continued)

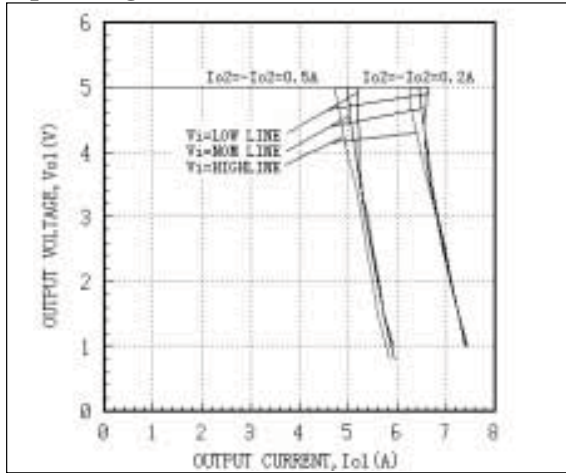

Fig. 19 AEW05ABB24 Main Output Character Curves
Tc=25°C

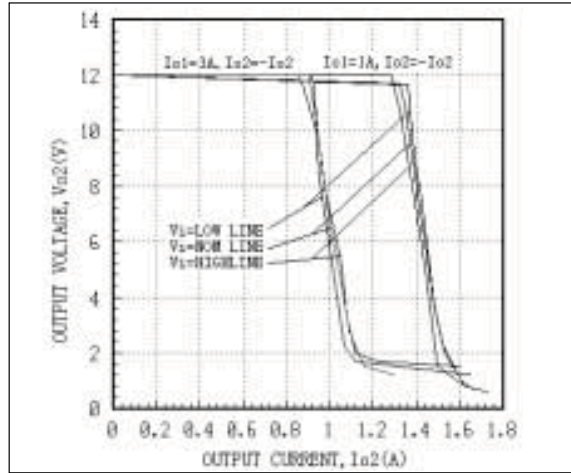

Fig. 20 AEW05ACC24 Auxiliary output Character Curves
Tc=25°C

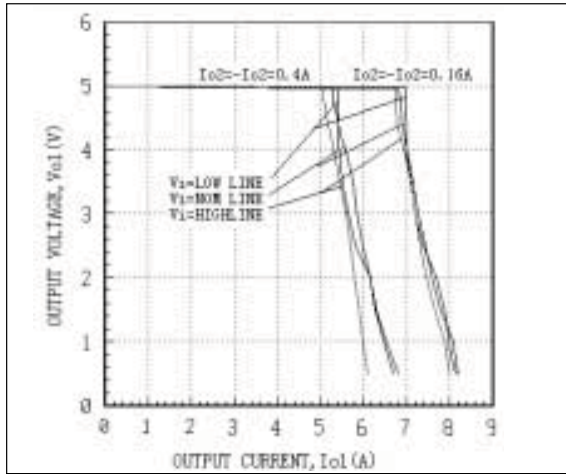

Fig. 21 AEW05ABB48 Main Output Character Curves
Tc=25°C

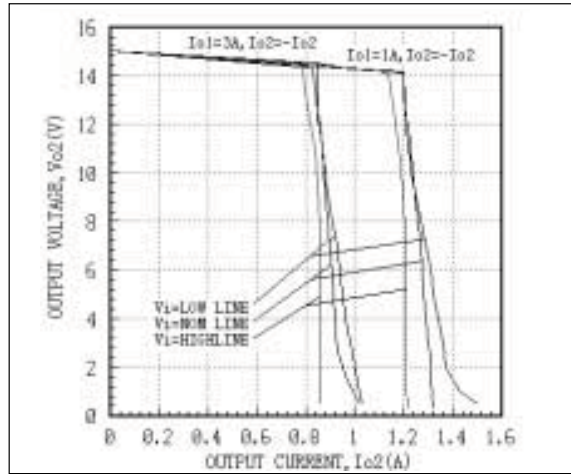

Fig. 22 AEW05ACC48 Auxiliary output Character Curves
Tc=25°C

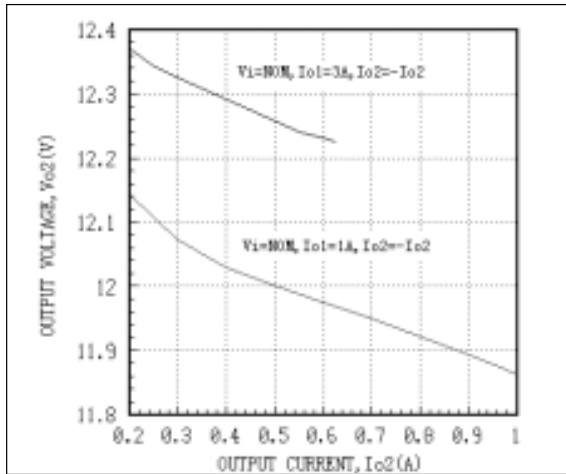

Fig. 23 AEW05ABB24 Load Regulation Curves
Tc=25°C

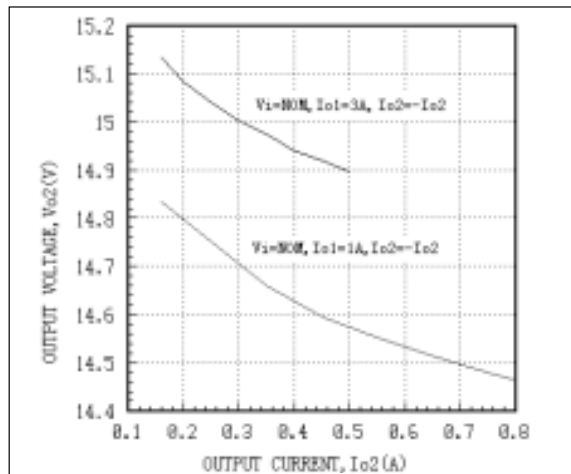

Fig. 24 AEW05ACC24 Load Regulation Curves
Tc=25°C

Operating characteristic (continued)

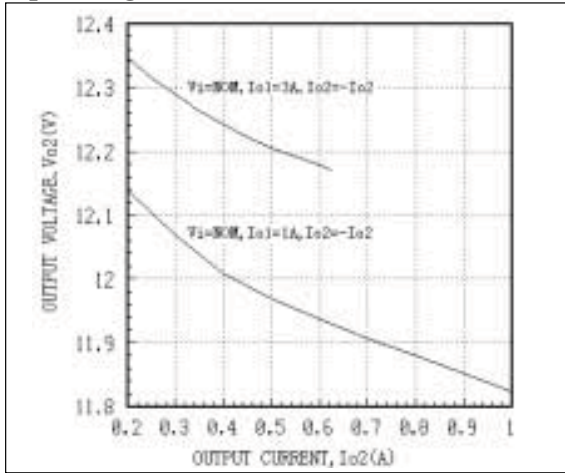

Fig. 25 AEW05ABB48 Load Regulation Curves
Tc=25°C

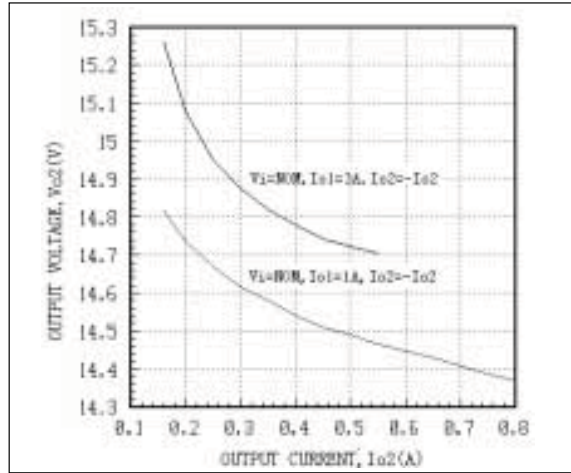

Fig. 26 AEW05ACC48 Load Regulation Curves
Tc=25°C

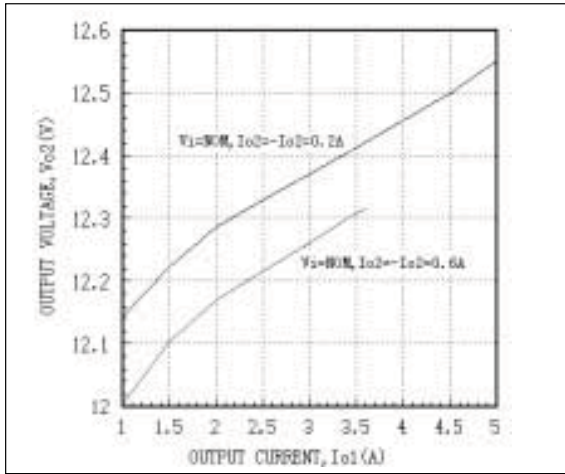

Fig. 27 AEW05ABB24 Cross Regulation Curves
Tc=25°C

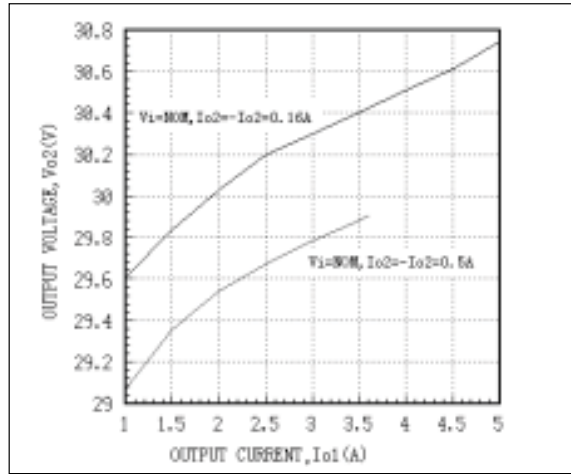

Fig. 28 AEW05ACC24 Cross Regulation Curves
Tc=25°C

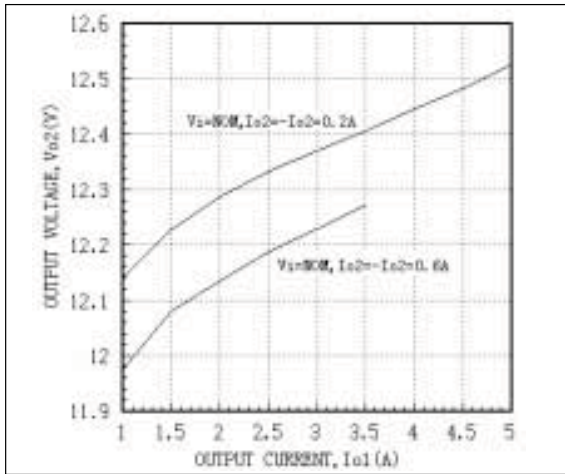

Fig. 29 AEW05ABB48 Cross Regulation Curves
Tc=25°C

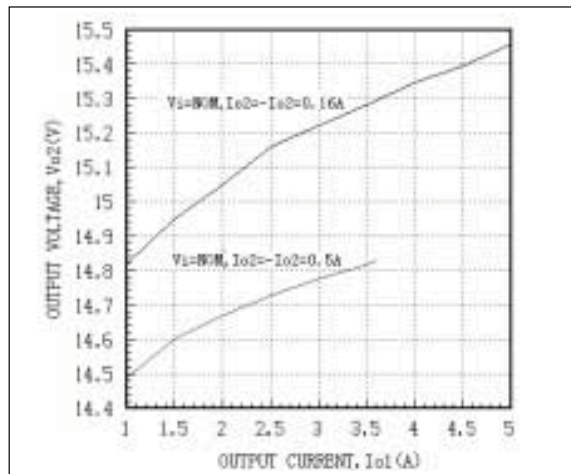

Fig. 30 AEW05ACC48 Cross Regulation Curves
Tc=25°C

Operating characteristic (continued)

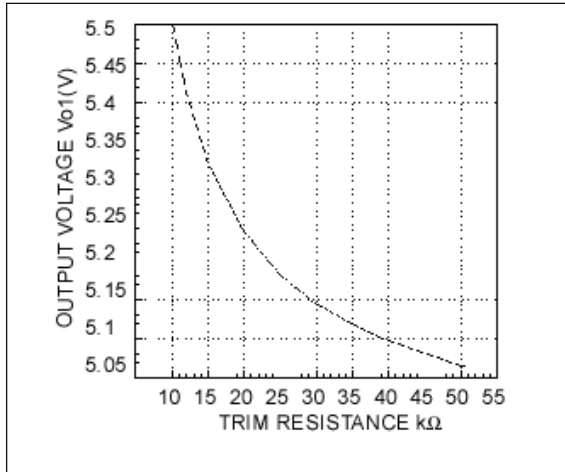

Fig. 31 AV30-*T* Trim Up
Rated voltage, rated current, Tc=25°C

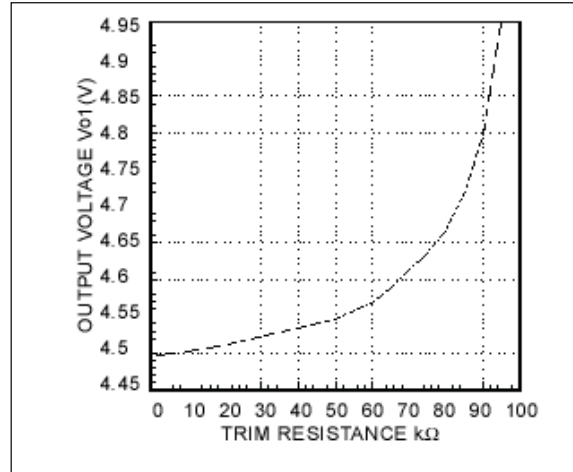

Fig. 32 AV30-*T* Trim Down
Rated voltage, rated current, Tc=25°C

AEW 30W Dual & Triple Output Series

Technical Reference Notes

1. Basic connections

- Dual output series

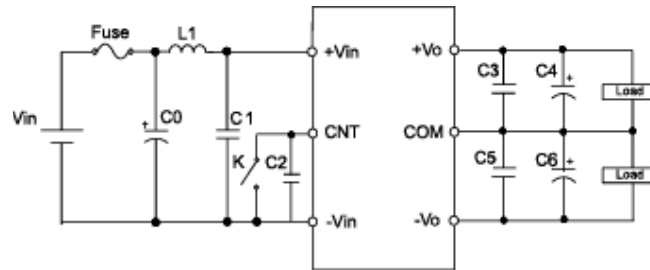

K disconnect, output on
K connect, output off

Fuse: 24Vin--5A
48Vin--2.5A

L1 10--12 μ H

C0 24Vin--1 μ F/50V film capacitor
48Vin--1 μ F/100V film capacitor

C1 47 μ F/100V high frequency electrolytic capacitor

C2 0.1 μ F

C3=C5 0.47 μ F/50V film capacitor

C4=C6 100 μ F/35V high frequency electrolytic capacitor

- Triple output series

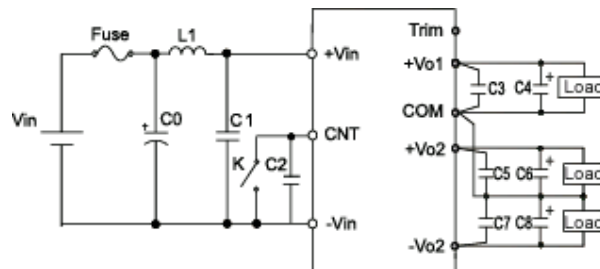

K disconnect, output on
K connect, output off

Fuse: 24Vin--5A
48Vin--2.5A

L1 10--12 μ H

C0 24Vin--1 μ F/50V film capacitor
48Vin--1 μ F/100V film capacitor

C1 100 μ F/100V high frequency electrolytic capacitor

C2 0.1 μ F

C3=C5=C7 0.47 μ F/50V film capacitor

C4 1000 μ F/16V high frequency electrolytic capacitor

C6=C8 220 μ F/35V high frequency electrolytic capacitor

TEL:
FAX:

USA	Europe	Asia
1-760-930-4600	44-(0)1384-842-211	852-2437-9662
1-760-930-0698	44-(0)1384-843-355	852-2402-4426



2. Function

2.1 CNT

- The products provide a control function allowing the user to turn the output on and off using an external circuit.
- When CNT disconnects or connects with +Vin or is in the midair, output is on. When CNT connects with -Vin directly, output is off.
- For 48Vin products, applying a voltage greater than 18V to the CNT pin will enable the output, while applying a voltage less than 4.5V will disable it. For 24Vin products, applying a voltage greater than 24V (it is unlimited when the CNT connects with +Vin directly.) will enable the output, while applying a voltage less than 4.5V will disable it. Grounding of CNT is -Vin.

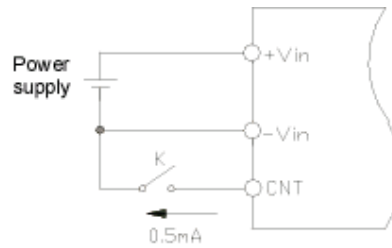

- K connects, output off
K disconnected, output on

- During operation, the working current of CNT is related to its input voltage.

Rated 24V input		Rated 48Vinput	
Vin(V)	ICNT(mA)	Vin(V)	ICNT(mA)
18	0.5	36	0.5
24	0.6	48	0.6
36	1	72	1

- ON/OFF control can be realized through mechanical switcher or transistor

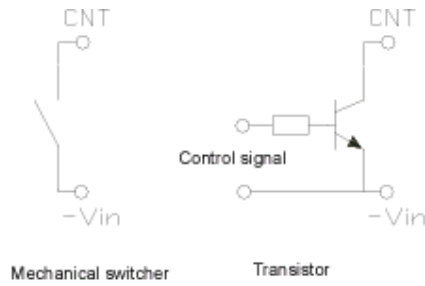

- In the isolated application, CNT control can be realized through optoisolator or relay.

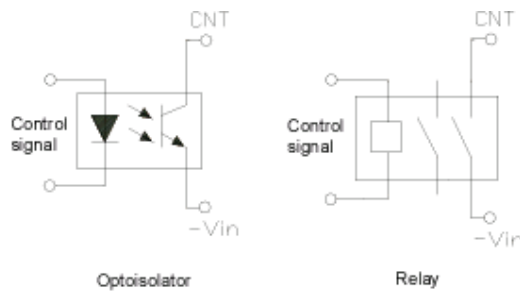

- It is recommended to parallel a 0.1 μ F capacitor to remove the interference when the control line is too long.
- When not use CNT function, connect CNT with +Vin.

2.2 input over/under voltage shutdown

- The module has input over/under voltage protection.
- When the input power is below 65%~75% rated input voltage, the input under-voltage protection active, output is cut off. There is a 1-2V hysteresis between the under-voltage shutdown point and restart up point.

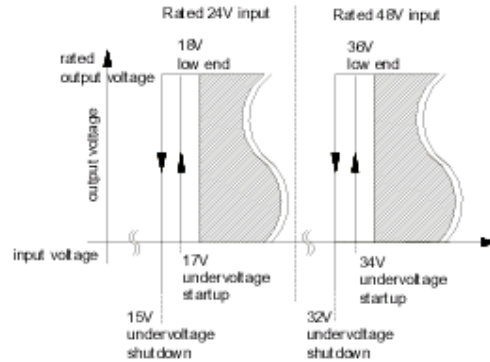

- When the input power is up than 150%~159% rated input voltage, the input over-voltage protection active, output is cut off. There is a 1-3V hysteresis between the over-voltage shutdown point and restart up point.

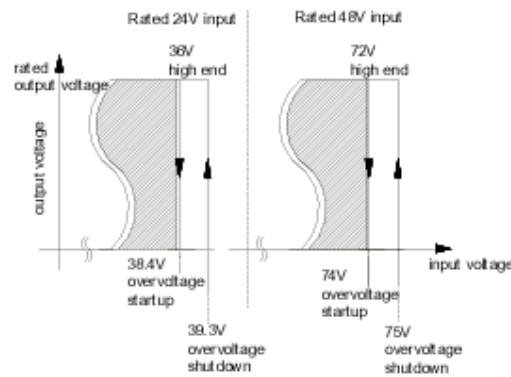

2.3 Output over-current protection

- AEW series DC/DC converters feature Over-current Protection (OCP) circuits. When output current exceeds 110% to 150% of rated current, such as during a short circuit condition, the output will shutdown immediately, and can tolerate short circuit conditions indefinitely.
- When the overcurrent condition is removed, the converter will automatically restart.

2.4 Output over-voltage shutdown (OVP)

- The AEW series provides over-voltage protection on the output, which will shut the output off if the voltage exceeds 116 to 150% of the nominal output voltage, and the output is shutdown.
- It must power the module on again to recover the output.
- If the module is trimmed up to the voltage, which exceeds the 110% rated output voltage, the output over-voltage protection will be probably triggered off.
- For dual output products:

Through testing the over-voltage condition between +Vo and -V, the over-voltage protection active (operating at 116% ~ 150% rated output voltage).

- For triple output products:

Through testing the over-voltage condition between +Vo and COM, the over-voltage protection active. When Vo1 exceeds 116%~150% rated output voltage, the over-voltage protection active. After the protection, please turn off the power supply, and restart after 2-3 seconds, the output will be normal.

2.5 Trim function

- Output voltage trim range is $\pm 10\%$. Trimming up by more than 10% of the nominal output may activate the OVP circuit or damage the converter. Trimming down more than 10% can cause improper regulation.
- The output voltage of the AEW series can be trimmed using the trim pin provided. Applying a voltage to the trim pin through a voltage divider or resistance from the output will cause the output to increase or decrease by up to 10%.
- When trimming a dual output converter, both outputs trim simultaneously.
- Trim down and trim up circuits and the corresponding configuration are shown in the following figures.

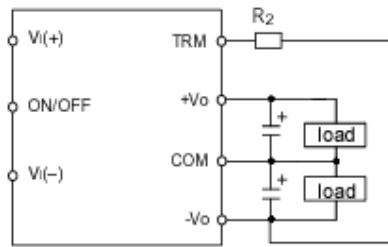

$$\pm 5V \text{ out: } R_2 = \frac{1.82}{y} - 0.01 \text{ k}\Omega$$

$$\pm 12V \text{ out: } R_2 = \frac{2.18}{y} - 0.01 \text{ k}\Omega$$

$$\pm 15V \text{ out: } R_2 = \frac{2.025}{y} - 0.01 \text{ k}\Omega$$

$$y = \frac{V_o - V_e}{V_e}$$

Dual output series trim up circuit

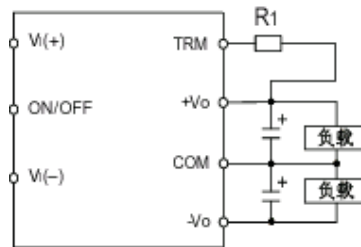

$$\pm 5V \text{ out: } R_1 = \frac{5.47}{y} - 7.3 \text{ k}\Omega$$

$$\pm 12V \text{ out: } R_1 = \frac{18.7}{y} - 20.91 \text{ k}\Omega$$

$$\pm 15V \text{ out: } R_1 = \frac{24.5}{y} - 26.74 \text{ k}\Omega$$

$$y = \frac{V_o - V_e}{V_e}$$

Dual output series trim down circuit

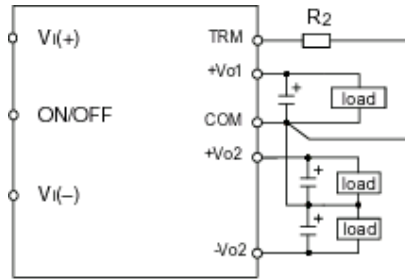

$$R_2 = \frac{1.25}{y} - 0.01 \text{ k}\Omega$$

Triple output series trim up circuit

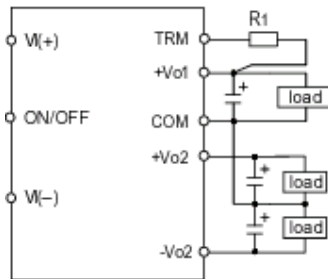

$$R_1 = \frac{1.25}{y} - 2.5 \text{ k}\Omega$$

Triple output series trim down circuit

V_{o--- trim output voltage, V_{e--- rated output voltage

Resistance is recommended: film capacitor, temperature coefficient $< \pm 300 \text{PPm}/^\circ\text{C}$

- Trimming up the output voltage, the output power should not exceed its rated output power.
- When not use trim function, please leave Trim pin in the midair.

3. Input and Output

3.1 Input fuse

The AEW power module has no internal fuse. An external fuse must always be employed! To meet international safety requirements, a 250 Volt rated fuse should be used. If one of the input lines is connected to chassis ground, then the fuse must be placed in the other input line.

Standard safety agency regulations require input fusing. Recommended fuse ratings for the AEH Series are shown in the following table:

Input voltage	Dual output	Triple output
Rated 24V input	5A	5A
Rated 48Vinput	2.5A	2.5A

3.2 Input filtering

- Input filters are included in the converters to help achieve standard system emissions certifications. Some users however, may find that additional input filtering is necessary. The AEW series has an internal switching frequency of 280 kHz so a high frequency capacitor mounted close to the input terminals produces the best results. To reduce reflected noise, a capacitor can be added across the input as shown in following figure, forming a π filter.

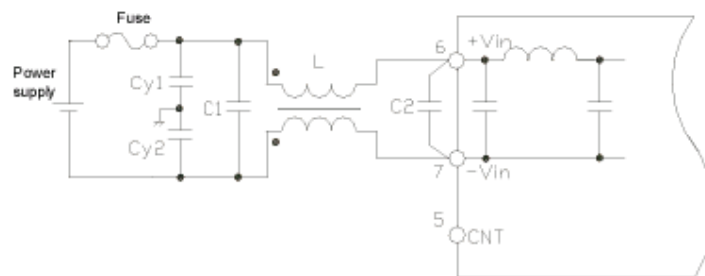

For conditions where EMI is a concern, a different input filter can be used. Following figure shows an input filter designed to reduce EMI effects.

- Recommended L & C:

TEL:	USA 1-760-930-4600	Europe 44-(0)1384-842-211	Asia 852-2437-9662
FAX:	1-760-930-0698	44-(0)1384-843-355	852-2402-4426

C1: 1uF/100V film capacitor, C2: 47uF/100V electrolytic capacitor

Cy1 Cy2 : 4700PF/50V capacitor

L: 1mH

3.3 Output filtering

- To reduce output ripple current, the output capacitor C_o should be added on the output.

$C_o=220\mu\text{F}/25\text{V}$ electrolytic capacitor

$C_3=1000\mu\text{F}/16\text{V}$ electrolytic capacitor

$C_2=C_4=C_6=0.47\mu\text{F}/50\text{V}$, $C_5=C_7=220\mu\text{F}/35\text{V}$

Dual output:

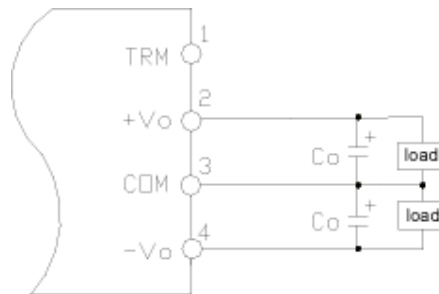

Triple output

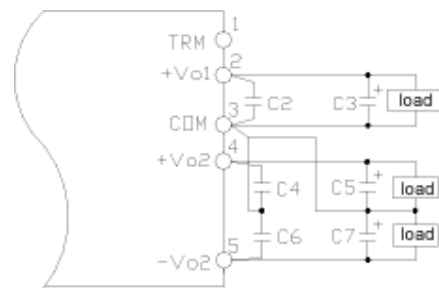

TEL:
FAX:

USA
1-760-930-4600
1-760-930-0698

Europe
44-(0)1384-842-211
44-(0)1384-843-355

Asia
852-2437-9662
852-2402-4426



4. Decoupling

Noise on the power distribution system is not always created by the converter. High-speed analog or digital loads with dynamic power demands can cause noise to cross the power inductor back onto the input lines. Noise can be reduced by decoupling the load. In most cases, connecting a 10 μF tantalum capacitor in parallel with a 0.1 μF ceramic capacitor across the load will decouple it. The capacitors should be connected as close to the load as possible.

5. Power dissipation

- Parallel Power Distribution

Following figure shows a typical parallel power distribution design. Such designs, sometimes called daisy chains, can be used for very low output currents, but are not normally recommended. The voltage across loads far from the source can vary greatly depending on the IR drops along the leads and changes in the loads closer to the source. Dynamic load conditions increase the potential problems.

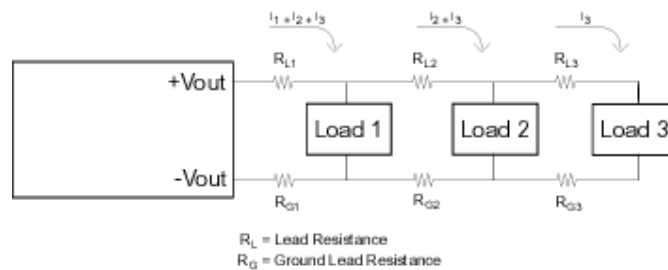

- Radial Power Distribution

Radial power distribution is the preferred method of providing power to the load. Figure 19 shows how individual loads are connected directly to the power source. This arrangement requires additional power leads, but it avoids the voltage variation problems associated with the parallel power distribution technique.

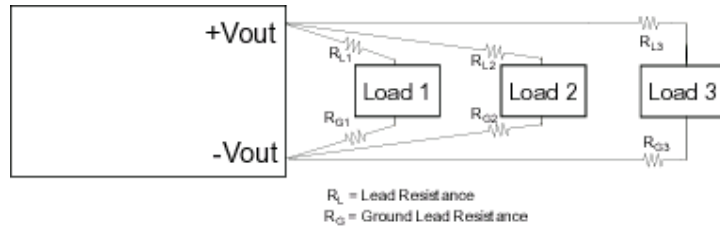

- Mixed Distribution

In the real world a combination of parallel and radial power distribution is often used. Dynamic and high current loads are connected using a radial design, while static and low current loads can be connected in parallel. This combined approach minimizes the drawbacks of a parallel design when a purely radial design is not feasible.

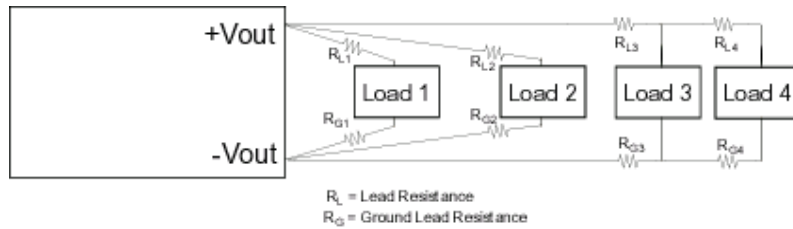

- Redundant Operation

A common requirement in high reliability systems is to provide redundant power supplies. The easiest way to do this is to place two converters in parallel, providing fault tolerance but not load sharing. Oring diodes should be used to ensure that failure of one converter would not cause failure of the second. Figure 21 shows such an arrangement. Upon application of power, one of the converters will provide a slightly higher output voltage and will support the full load demand. The second converter will see a zero load condition and will idle. If the first converter should fail, the second converter will support the full load. When designing redundant converter circuits, Schottky diodes should be used to minimize the forward voltage drop. The voltage drop across the Schottky diodes must also be considered when determining load voltage requirements. \

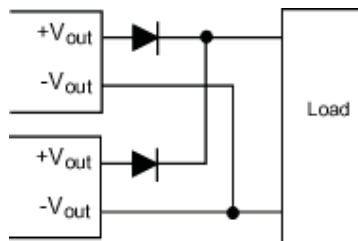

6. Input Reverse Voltage Protection

Under installation and cabling conditions where reverse polarity across the input may occur, reverse polarity protection is recommended. Protection can easily be provided as shown in following. In both cases the diode used is rated for 2A/100V. Placing the diode across the inputs rather than in-line with the input offers an advantage in that the diode only conducts in a reverse polarity condition, which increases circuit efficiency and thermal performance.



7. Series operating

When converters are connected in series to increase the output voltage, diodes should be added as shown in following figure. Choose low forward voltage drop diodes, such as shottky diodes. The reverse voltage of the diode should be greater than the output voltage, and the diode's turn-on current should be greater than the series load current. The maximum operating output current of the series connection should not be greater than the maximum output current of any single converter.

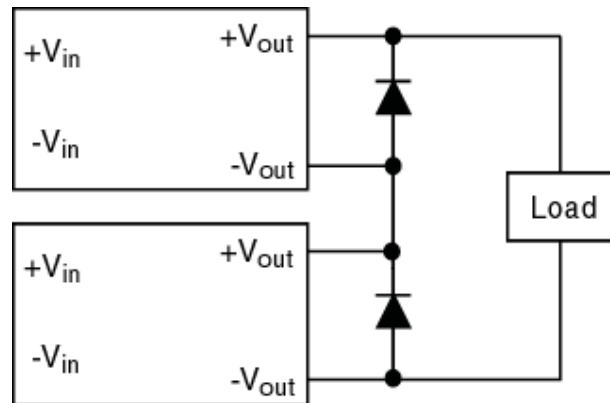

8. Installation

- Installation method

AEW series converters can be mounted in any orientation, but care should be taken to allow for free airflow. Common placement techniques put heat sources such as power components at the end of the airflow path or provide separate airflow paths. This arrangement keeps other system equipment cooler and increases component life spans.

- Derating Curves

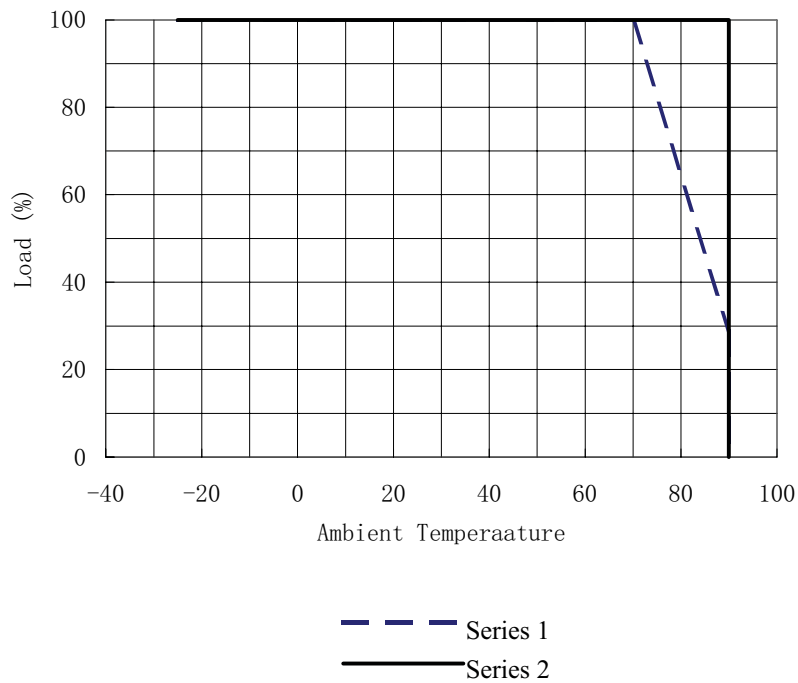

series 1: natural convection

series 2: maximum case temperature 90°C

9. Soldering

- Soldering temperature

Wave soldering: 260°C, time < 10S. 110°C preheating 20~30S.

Pin soldering: 400°C, time < 5S

- Cleaning

Cleaning solvent: IPA

Cleaning method: soaking for cleaning

TEL:	USA 1-760-930-4600	Europe 44-(0)1384-842-211	Asia 852-2437-9662
FAX:	1-760-930-0698	44-(0)1384-843-355	852-2402-4426

