

63470-1 ✓ ACTIVE

FASTON | FASTON 187

TE Internal #: 63470-1

Quick Disconnects, Receptacle, 18 – 16 AWG Wire Size, .82 – 1.31 mm² Wire Size, Mating Tab Width 4.75 mm [.187 in], Straight, Brass, FASTON 187

[View on TE.com >](#)



Terminals & Splices > Quick Disconnects

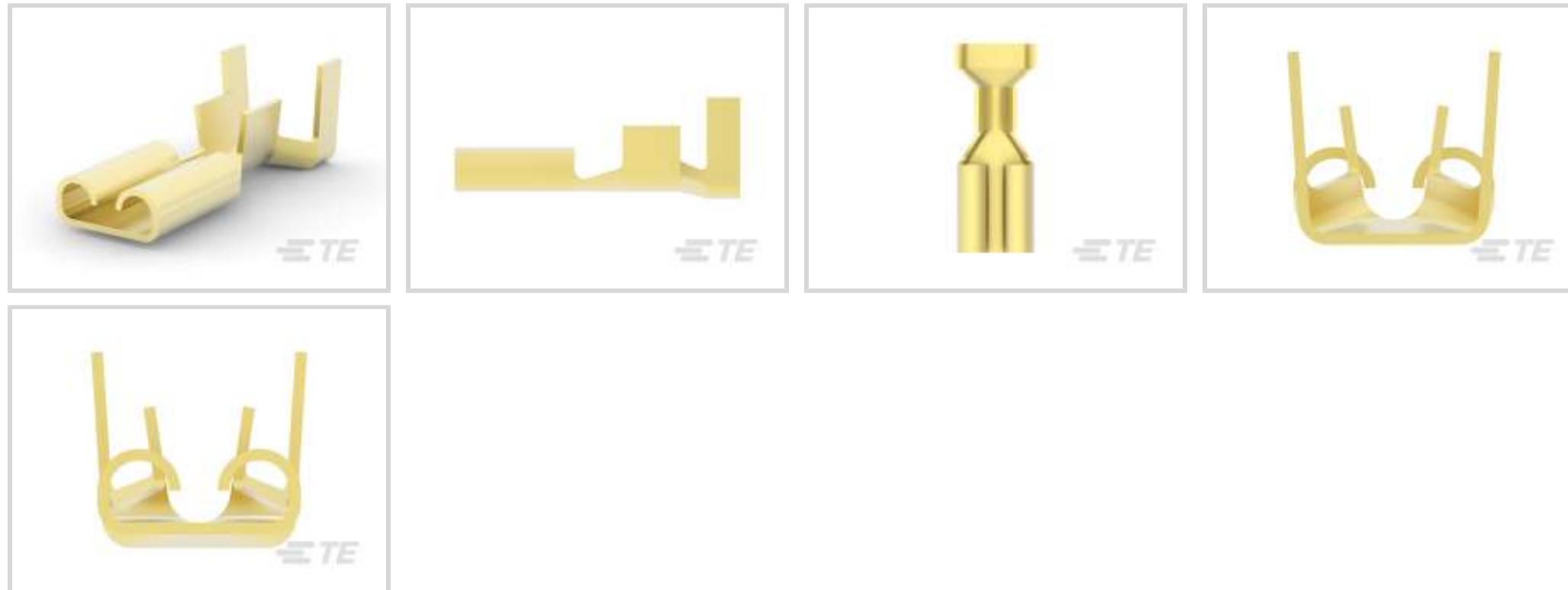

Quick Disconnect Terminal Type: **Receptacle**

Wire Size: .82 – 1.31 mm²

Mating Tab Width: 4.75 mm [.187 in]

Mating Tab Thickness: .51 mm [.02 in]

Features

Product Type Features

Insertion Force	Normal
-----------------	--------

Configuration Features

Connection Capacity	Single
---------------------	--------

Compatible With Wire & Cable Type	Discrete Wire
-----------------------------------	---------------

Contact Features

Quick Disconnect Terminal Type	Receptacle
--------------------------------	------------

Mating Tab Width	4.75 mm [.187 in]
------------------	-------------------

Mating Tab Thickness	.51 mm [.02 in]
----------------------	-----------------

Terminal Orientation	Straight
----------------------	----------

Contact Base Material	Brass
-----------------------	-------

Terminal Plating Material	Unplated
---------------------------	----------

Crimp Type	F-Crimp
------------	---------

Barrel Type	Open
-------------	------

Termination Features



Product Terminates To	Wire & Cable
-----------------------	--------------

Mechanical Attachment

Wire Insulation Support	With
Mating Retention Type	Dimple

Dimensions

Terminal Material Thickness	.3 mm[.012 in]
Product Length	14.99 mm[.59 in]
Compatible Insulation Diameter Range	2.67 – 5.33 mm[.105 – .21 in]
Wire Size	.82 – 1.31 mm ²

Usage Conditions

Insulation Option	Uninsulated
Operating Temperature Range	-40 – 110 °C[-40 – 230 °F]

Industry Standards

Agency/Standard	CSA, UL
-----------------	---------

Packaging Features

Packaging Quantity	18000
Packaging Method	Strip/Reel

Product Compliance

[For compliance documentation, visit the product page on TE.com>](#)

EU RoHS Directive 2011/65/EU	Compliant
EU ELV Directive 2000/53/EC	Compliant
China RoHS 2 Directive MIIT Order No 32, 2016	No Restricted Materials Above Threshold
EU REACH Regulation (EC) No. 1907/2006	Current ECHA Candidate List: JUNE 2023 (235) Candidate List Declared Against: JAN 2021 (211) Does not contain REACH SVHC
Halogen Content	Low Halogen - Br, Cl, F, I < 900 ppm per homogenous material. Also BFR/CFR/PVC Free
Solder Process Capability	Not applicable for solder process capability

Product Compliance Disclaimer

This information is provided based on reasonable inquiry of our suppliers and represents our current actual knowledge based on the information they provided. This information is subject to change. The part numbers that TE has identified as EU RoHS compliant have a maximum concentration of 0.1% by weight in homogenous materials for lead, hexavalent chromium, mercury, PBB, PBDE, DBP, BBP, DEHP, DIBP, and 0.01% for cadmium, or qualify for an exemption to these limits as defined in the Annexes of Directive 2011/65/EU (RoHS2). Finished electrical and electronic equipment products will be CE marked as required by Directive 2011/65/EU. Components may not be CE marked. Additionally, the part numbers that TE has identified as EU ELV compliant have a maximum concentration of 0.1% by weight in homogenous materials for lead, hexavalent chromium, and mercury, and 0.01% for cadmium, or qualify for an exemption to these limits as defined in the Annexes of Directive 2000/53/EC (ELV). Regarding the REACH Regulation, the information TE provides on SVHC in articles for this part number is based on the latest European Chemicals Agency (ECHA) 'Guidance on requirements for substances in articles' posted at this URL: <https://echa.europa.eu/guidance-documents/guidance-on-reach>

Compatible Parts



Also in the Series | FASTON 187

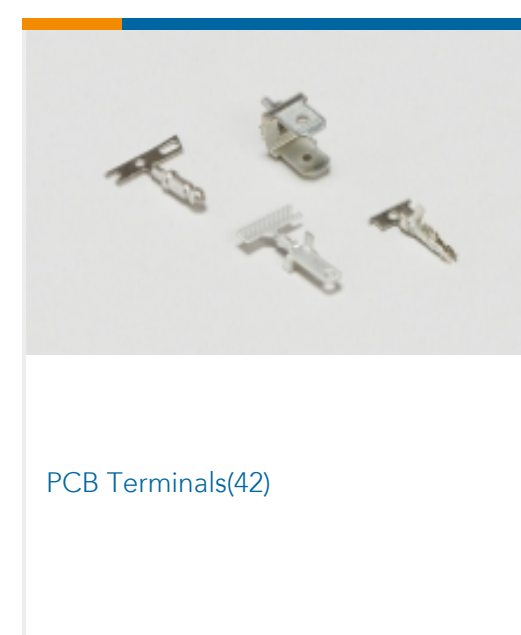
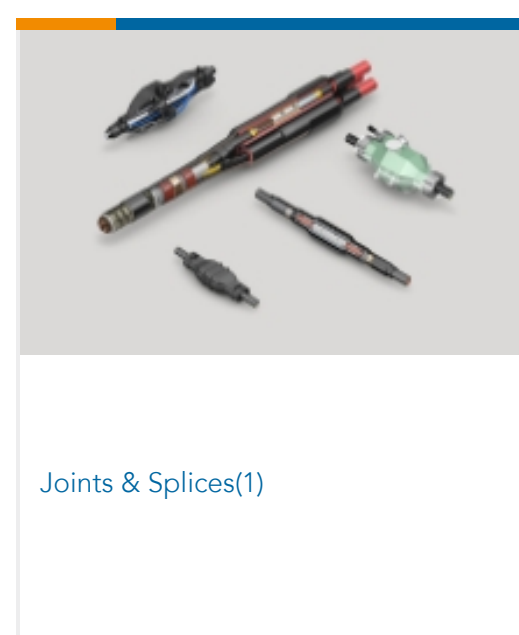
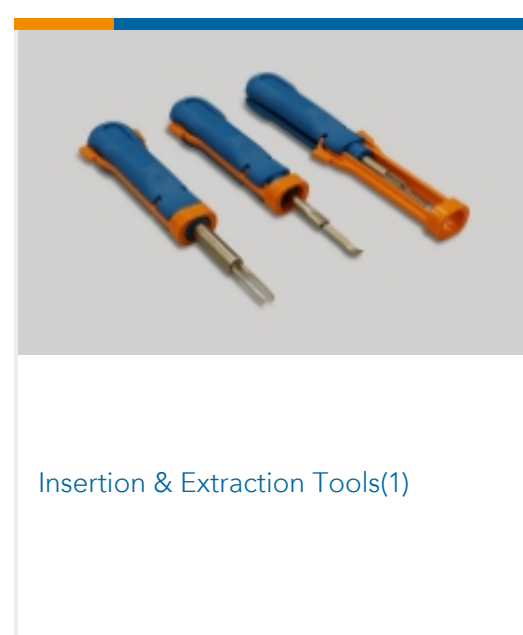
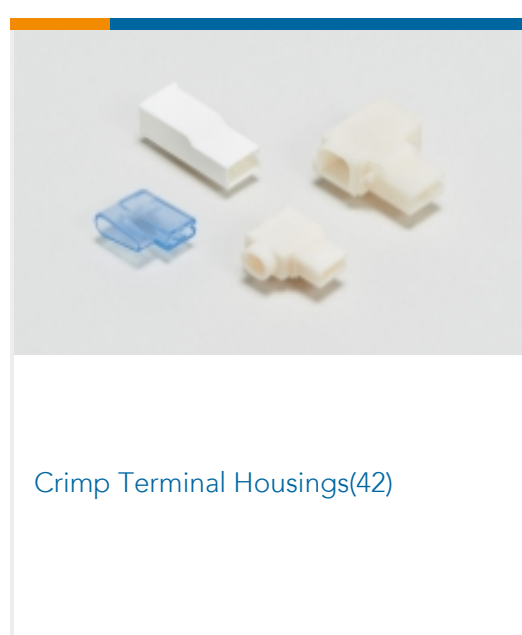



Quick Disconnects(209)



Splices(1)

Customers Also Bought



TE Part #5-1971773-3
High Temperature Plug — POWER
TRIPLE LOCK

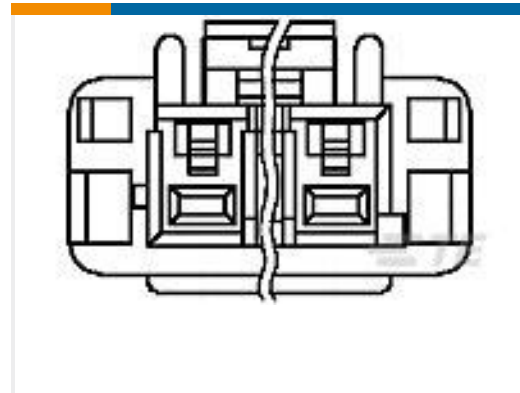

TE Part #1376388-1
5MM POWER KEY 2P PLUG HSG NUT



TE Part #521368-2
ULTRA-POD 250 ASSY REC 22-18
AWG TPBR

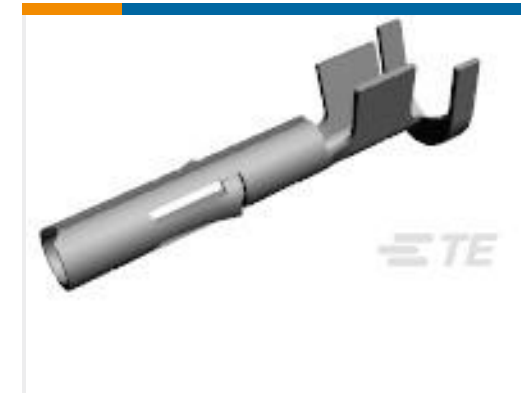

TE Part #350874-1
UMNL SOK 18-14 .0126 PTPBR



TE Part #1969632-1
250 FASTON HSG.,REC.,1 POS,BLACK



TE Part #40661
RING 190(4.82 MM) TERMINAL 18-14
AWG BR



TE Part #1969843-1
187 FAST & 110 PL HSG.,REC.,3P,
BLACK



TE Part #5-520181-2
ULTRA-FAST 187 ASY REC 22-18 AWG
TPBR



TE Part #686941-000
VERSAFIT-3/8-0-1.5IN-SM

Documents

Product Drawings

[187 FASTON REC 18-16 AWG BR](#)

English

CAD Files

Customer View Model

[ENG_CVM_CVM_63470-1_G.2d_dxf.zip](#)

English

[3D PDF](#)



3D

Customer View Model

[ENG_CVM_CVM_63470-1_G.3d_igs.zip](#)

English

Customer View Model

[ENG_CVM_CVM_63470-1_G.3d_stp.zip](#)

English

By downloading the CAD file I accept and agree to the [Terms and Conditions](#) of use.

Datasheets & Catalog Pages

[82004 FASTON Terminals \(Insulated and Uninsulated\) Catalog - FASTON Receptacles Section](#)

English

Product Specifications

[Application Specification](#)

English

Product Environmental Compliance

[TE Material Declaration](#)

English