

THIS DRAWING IS UNPUBLISHED. RELEASED FOR PUBLICATION
 © COPYRIGHT - By - ALL RIGHTS RESERVED.

| LOC | | DIST | | REVISIONS | | | |
|-----|-----|---------------------------|--|-----------|-----|------|--|
| P | LTR | DESCRIPTION | | DATE | DWN | APVD | |
| | D9 | REVISED PER ECO-12-012202 | | 03JUL12 | KH | MS | |

PHYSICAL PROPERTIES:
 HOUSING MATERIAL: PBT
 FLAMMABILITY: UL94V-0
 COLOR: BLACK

TERMINAL:
 TERMINALS: BRASS, TIN PLATED
 SCREWS: 6-32, STEEL, NICKEL PLATED

MECHANICAL:
 PITCH (TERMINAL SPACING): 9.50mm (.374")
 WIRE RANGE: 12-22 AWG
 RECOMMENDED TIGHTENING TORQUE: 12IN-LBS MAX.

ELECTRICAL PROPERTIES:
 MAXIMUM CURRENT: 20A
 OPERATING VOLTAGE: 300V

ENVIRONMENTAL PROPERTIES:
 OPERATING TEMP RANGE: -40°C TO 120°C

- ① SCREWS ON ONE SIDE IN WIRE READY POSITION.
- ② SEE FIGURE.
- ③ WHITE INK STAMP.
- ④ NICKEL PLATED BRASS SCREWS.
- ⑤ PRELIMINARY PART NUMBER.
- ⑥ TE CONNECTIVITY LOGO LOCATED APPROXIMATE AREA SHOWN.

| LOC | DIST | P | LTR | DESCRIPTION | DATE | DWN | APVD |
|------|------|-------|-------|--------------------------------|--------------------|------------|-------------|
| ⑤② | | | | 104.7 112.2 - - 10 4-1546307-7 | | | |
| ⑤② | | | | 104.7 112.2 - - 10 4-1546307-6 | | | |
| ⑤④ | | | | 104.7 112.2 - - 10 4-1546307-5 | | | |
| ⑤②① | | | | 104.7 112.2 - - 10 3-1546307-3 | | | |
| | | | | 104.7 112.2 - - 10 1-1546307-0 | | | |
| ⑤③②① | | | | 95.2 102.7 - 9 9 5-1546307-0 | | | |
| ⑤③②① | | | | 95.2 102.7 4 9 9 4-1546307-9 | | | |
| ③②① | | | | 95.2 102.7 4 9 9 4-1546307-8 | | | |
| | | | | 95.2 102.7 - - 9 1546307-9 | | | |
| | | | | 85.7 93.2 - - 8 1546307-8 | | | |
| | | | | 76.2 83.7 - - 7 1546307-7 | | | |
| ⑤④ | | | | 66.7 74.2 - - 6 4-1546307-4 | | | |
| | | | | 66.7 74.2 - - 6 1546307-6 | | | |
| ⑤② | | | | 57.2 64.7 - - 5 4-1546307-3 | | | |
| ⑤② | | | | 57.2 64.7 - - 5 4-1546307-2 | | | |
| ⑤② | | | | 57.2 64.7 - - 5 4-1546307-1 | | | |
| ⑤② | | | | 57.2 64.7 - - 5 4-1546307-0 | | | |
| ⑤④ | | | | 57.2 64.7 - - 5 3-1546307-9 | | | |
| | | | | 57.2 64.7 - - 5 1546307-5 | | | |
| ⑤②① | | | | 47.7 55.2 - - 4 3-1546307-2 | | | |
| | | | | 47.7 55.2 - - 4 1546307-4 | | | |
| ⑤② | | | | 38.2 45.7 - - 3 3-1546307-8 | | | |
| ⑤② | | | | 38.2 45.7 - - 3 3-1546307-7 | | | |
| ⑤② | | | | 38.2 45.7 - - 3 3-1546307-6 | | | |
| ⑤② | | | | 38.2 45.7 - - 3 3-1546307-5 | | | |
| ⑤④ | | | | 38.2 45.7 - - 3 3-1546307-4 | | | |
| | | | | 38.2 45.7 - - 3 1546307-3 | | | |
| | | | | 28.7 36.2 - - 2 1546307-2 | | | |
| | | DIM B | DIM A | QC TAB .187 45° ② | QC TAB .187 FLAT ① | NO OF POSN | PART NUMBER |

| | | | | | | | |
|---|--|--------------------------|---|--------------|-----------------|----------------------|-----------------|
| THIS DRAWING IS A CONTROLLED DOCUMENT. | | DWN S SCHLEGEL 20AUG2002 |  TE Connectivity | | | | |
| DIMENSIONS: mm | | CHK C RICHARD 8/20/02 | | | | | |
| TOLERANCES UNLESS OTHERWISE SPECIFIED: | | APVD C RICHARD 8/20/02 | NAME 9.50MM (.374) DBL ROW BARRIER STRIP W/ WASHER | | | | |
| 0 PLC ± - 1 PLC ± 0.3 2 PLC ± 0.25 3 PLC ± - 4 PLC ± - ANGLES ± 2° | | PRODUCT SPEC - | APPLICATION SPEC - | | | | |
| MATERIAL - | | FINISH - | WEIGHT - | SIZE A3 | CAGE CODE 00779 | DRAWING NO C-1546307 | RESTRICTED TO - |
| CUSTOMER DRAWING | | | SCALE 1:1 | SHEET 1 OF 3 | REV D9 | | |

THIS DRAWING IS UNPUBLISHED. RELEASED FOR PUBLICATION
 © COPYRIGHT - By - ALL RIGHTS RESERVED.

| LOC | DIST | REVISIONS | | | |
|-----|------|-------------|------|-----|------|
| P | LTR | DESCRIPTION | DATE | DWN | APVD |
| - | - | SEE SHEET 1 | - | - | - |

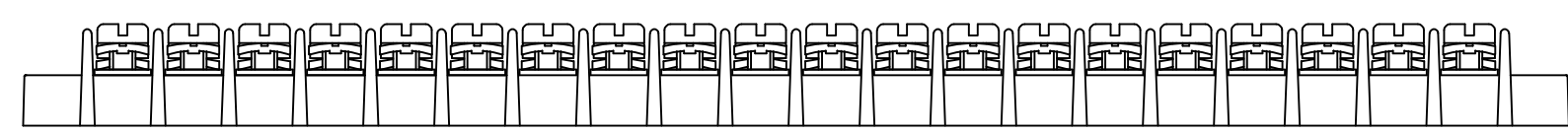

3-1546307-1

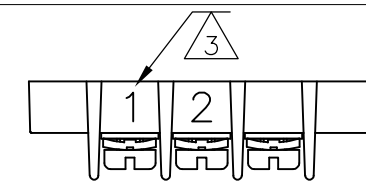
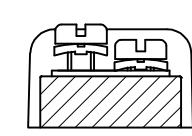

3-1546307-5

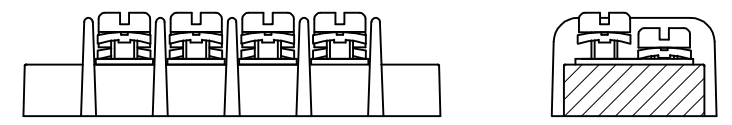

3-1546307-2

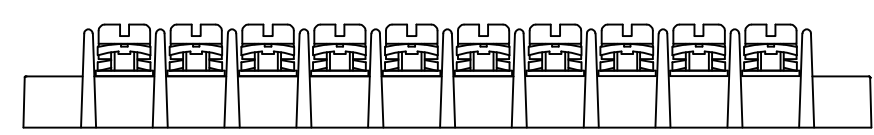
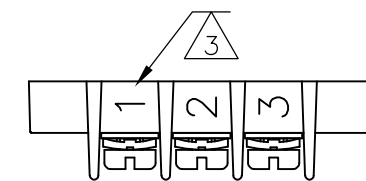
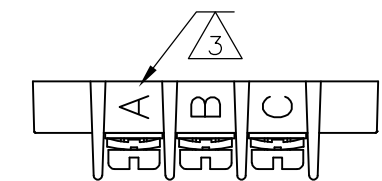
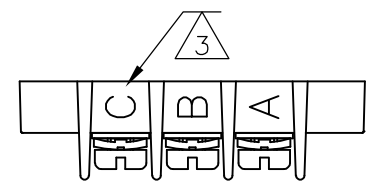
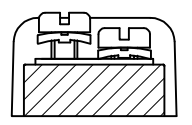

3-1546307-3

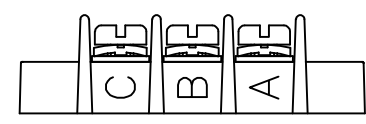
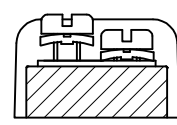

3-1546307-7

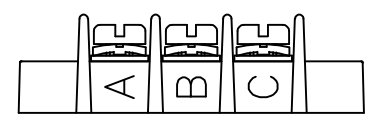

3-1546307-8

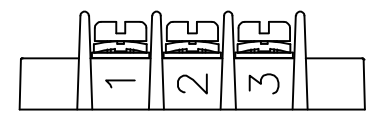

3-1546307-6

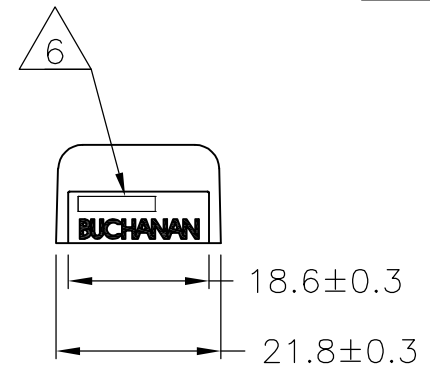
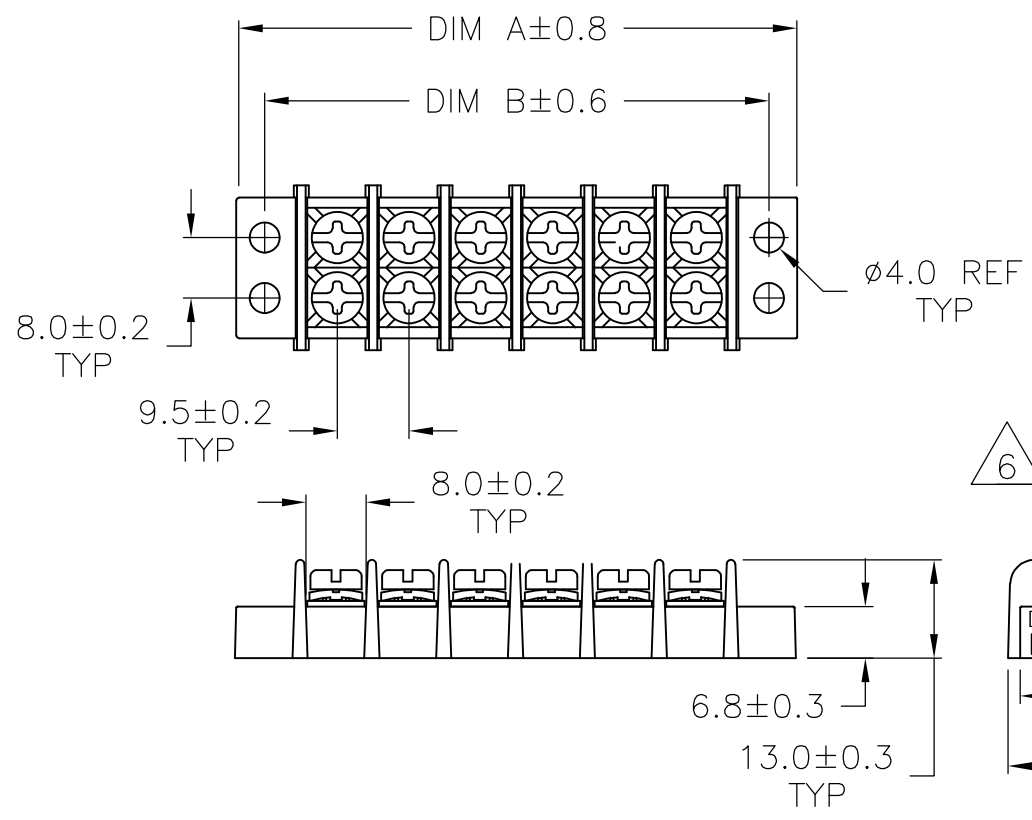

| | | | | | |
|-------|-------|-------------------|--------------------|------------|-------------|
| 294.7 | 302.2 | - | - | 30 | 3-1546307-0 |
| 285.2 | 292.7 | - | - | 29 | 2-1546307-9 |
| 275.7 | 283.2 | - | - | 28 | 2-1546307-8 |
| 266.2 | 273.7 | - | - | 27 | 2-1546307-7 |
| 256.7 | 264.2 | - | - | 26 | 2-1546307-6 |
| 247.2 | 254.7 | - | - | 25 | 2-1546307-5 |
| 237.7 | 245.2 | - | - | 24 | 2-1546307-4 |
| 228.2 | 235.7 | - | - | 23 | 2-1546307-3 |
| 218.7 | 226.2 | - | - | 22 | 2-1546307-2 |
| 209.2 | 216.7 | - | - | 21 | 2-1546307-1 |
| 199.7 | 207.2 | - | - | 20 | 3-1546307-1 |
| 199.7 | 207.2 | - | - | 20 | 2-1546307-0 |
| 190.2 | 197.7 | - | - | 19 | 1-1546307-9 |
| 180.7 | 188.2 | - | - | 18 | 1-1546307-8 |
| 171.2 | 178.7 | - | - | 17 | 1-1546307-7 |
| 161.7 | 169.2 | - | - | 16 | 1-1546307-6 |
| 152.2 | 159.7 | - | - | 15 | 1-1546307-5 |
| 142.7 | 150.2 | - | - | 14 | 1-1546307-4 |
| 133.2 | 140.7 | - | - | 13 | 1-1546307-3 |
| 123.7 | 131.2 | - | - | 12 | 1-1546307-2 |
| 114.2 | 121.7 | - | - | 11 | 1-1546307-1 |
| DIM B | DIM A | QC TAB .187 45° ② | QC TAB .187 FLAT ① | NO OF POSN | PART NUMBER |

| | | | | | |
|---|--|--------------------------|-----------------|--------------|----------------------|
| THIS DRAWING IS A CONTROLLED DOCUMENT. | | DWN S SCHLEGEL 20AUG2002 | TE Connectivity | | |
| DIMENSIONS: mm | | CHK C RICHARD 8/20/02 | | | |
| TOLERANCES UNLESS OTHERWISE SPECIFIED: | | APVD C RICHARD 8/20/02 | PRODUCT SPEC | | SIZE A3 |
| 0 PLC ± - 1 PLC ± 0.3 2 PLC ± 0.25 3 PLC ± - 4 PLC ± - ANGLES ± 2° | | APPLICATION SPEC | CAGE CODE 00779 | | DRAWING NO C-1546307 |
| MATERIAL - | | WEIGHT - | RESTRICTED TO - | | SCALE 1:1 |
| | | CUSTOMER DRAWING | | SHEET 2 OF 3 | REV D9 |

THIS DRAWING IS UNPUBLISHED.

RELEASED FOR PUBLICATION

ALL RIGHTS RESERVED.

© COPYRIGHT - By -

LOC -

DIST -

P -

LTR -

REVISIONS

DESCRIPTION

SEE SHEET 1

DATE

DWN

APVD

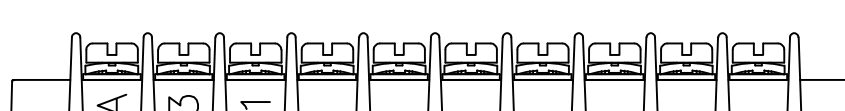
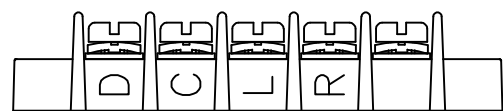
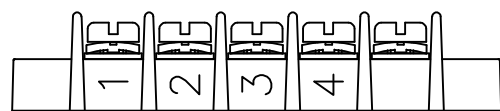
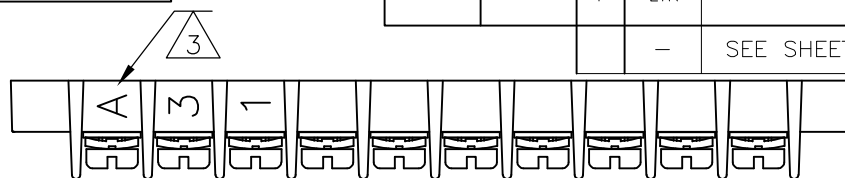
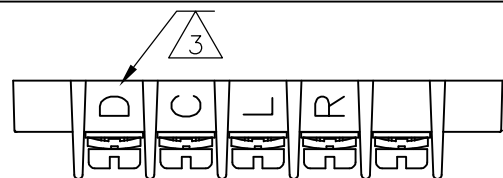
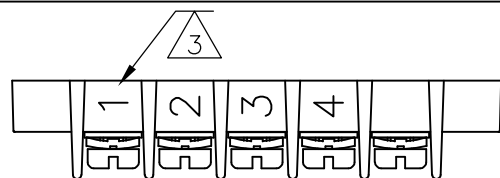

4-1546307-2

4-1546307-3

4-1546307-7

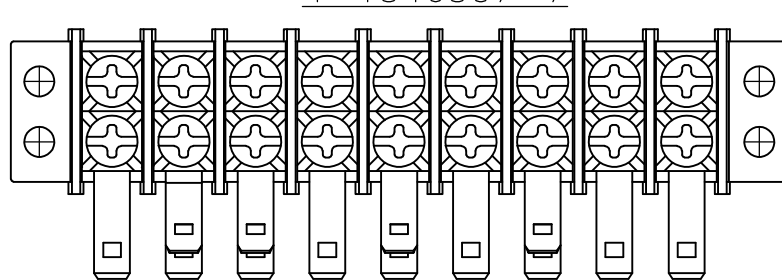
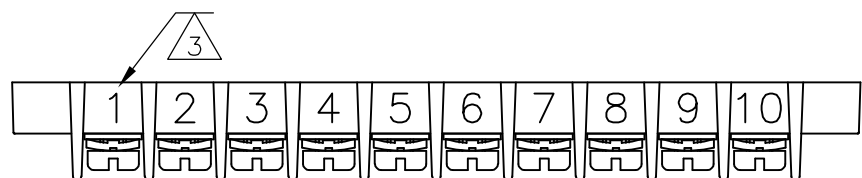

4-1546307-6

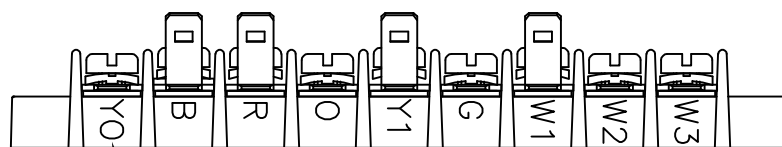
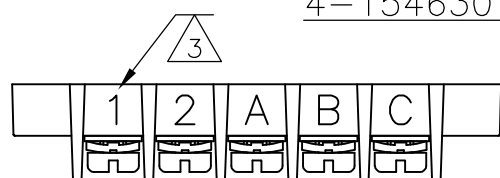

4-1546307-0

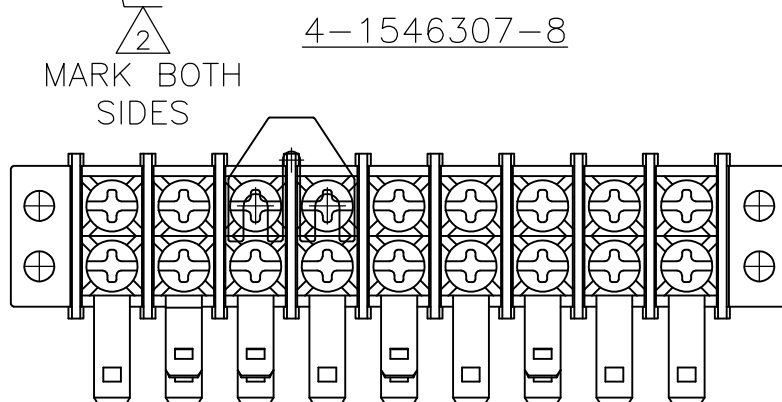
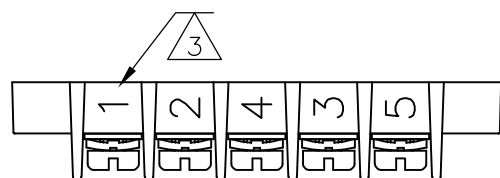

4-1546307-1

MARK BOTH SIDES

4-1546307-8

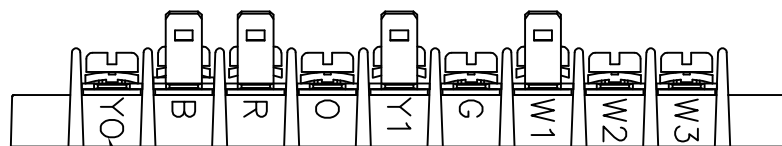
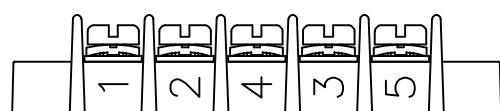

4-1546307-1

MARK BOTH SIDES

4-1546307-9

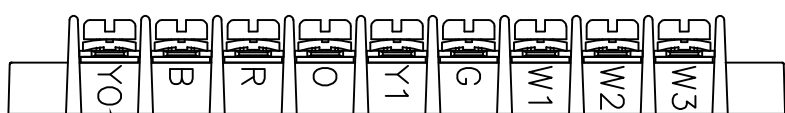
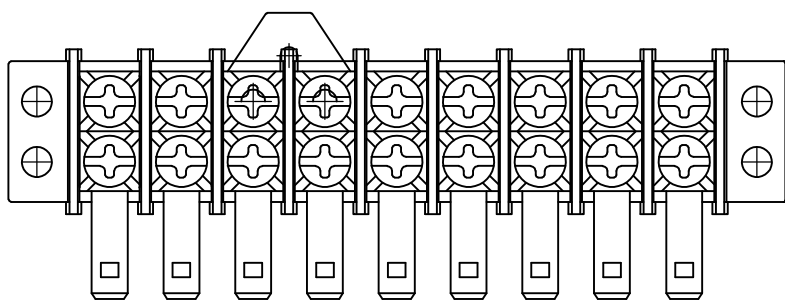

5-1546307-0

MARK BOTH SIDES

THIS DRAWING IS A CONTROLLED DOCUMENT.

DIMENSIONS:

mm

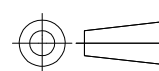

TOLERANCES UNLESS OTHERWISE SPECIFIED:

- 0 PLC ± -
- 1 PLC ± 0.3
- 2 PLC ± 0.25
- 3 PLC ± -
- 4 PLC ± -
- ANGLES ± 2'
- FINISH -

MATERIAL

DWN 20AUG2002

S SCHLEGEL

CHK 8/20/02

C RICHARD

APVD 8/20/02

C RICHARD

PRODUCT SPEC

APPLICATION SPEC

WEIGHT



TE Connectivity

9.50MM (.374) DBL ROW BARRIER STRIP W/ WASHER

| | | | | |
|------|------|-----------|------------|---------------|
| NAME | SIZE | CAGE CODE | DRAWING NO | RESTRICTED TO |
| | A3 | 00779 | C-1546307 | - |

CUSTOMER DRAWING

SCALE 1:1

SHEET 3 OF 3

REV D9