

### Device Features

- OIP3 = 35.0 dBm @ 1900 MHz
- Gain = 13.3 dB @ 1900 MHz
- Output P1 dB = 18.5 dBm @ 1900 MHz
- Patented temperature compensation
- RoHS2-compliant SOT-89 SMT package



### Product Description

BeRex's BG13B is a high performance InGaP/GaAs HBT MMIC amplifier, internally matched to 50 Ohms and uses a patented **temperature compensation** circuit to provide stable current over the operating temperature range without the need for external components. The BG13B is designed for high linearity gain block applications that require excellent gain flatness. It is packaged in a RoHS2-compliant with SOT-89 surface mount package.

### Applications

- Base station Infrastructure/RFID
- Commercial/Industrial/Military wireless system

### Applications Circuit

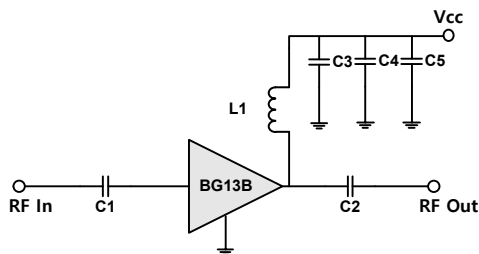

\*C1, C2, C3 = 100 pF ± 5%; C4 = 1000 pF ± 5%; C5 = 10uF; L1 = 22nH ± 5%

\*Less than 20nH improves RF performance at over 1.9GHz.

\*100nH or higher value L1 improves RF performance at under 500MHz.

\*Optimum value of L1 may vary with board design.

(L1:100nH for 500MHz, L1:1200nH, C1&C2:6800pF for 70MHz)

### Electrical Specifications

Device performance \_ measured on a BeRex evaluation board at 25°C, Vc=5V, 50 Ω system.

Parameter	Conditions	Min	Typ	Max	Unit
Operational Frequency Range		5		6000	MHz
Test Frequency			1900		MHz
Gain		11.8	13.3		dB
Input Return Loss			-16.3		dB
Output Return Loss			-11.1		dB
Output IP3	7 dBm / tone , Δf=1 MHz	32.0	35.0		dBm
Output P1dB		17.5	18.5		dBm
Noise Figure			8.3		dB

### Recommended Operating Conditions

Parameter	Min	Typ	Max	Unit
Bandwidth	5		6000	MHz
I <sub>c</sub> @ (V <sub>c</sub> = 5V)	56	70	84	mA
V <sub>c</sub>	3.5	5	5.25	V
dG/dT		-0.004		dB/°C
R <sub>TH</sub>		85.0		°C/W
Operating Case Temperature	-40		+85	°C

Electrical specifications are measured at specified test conditions.

Specifications are not guaranteed over all recommended operating conditions.

### Absolute Maximum Ratings

Parameter	Rating	Unit
Storage Temperature	-55 to +155	°C
Junction Temperature	+180	°C
Supply Voltage	+6.0	V
Supply Current	150	mA
Input RF Power	23	dBm

Operation of this device above any of these parameters may result in permanent damage.

**5-6000 MHz Cascadable InGaP HBT Gain Block**

Typical Performance (Vc = 5V, Ic = 70mA, T = 25°C)

Freq	MHz	70	500	900	1900	2140	2450	3500	5800
S21	dB	13.9	13.7	13.5	13.3	13.0	12.5	12.1	10.8
S11	dB	-17.0	-16.5	-16.2	-21.2	-25.0	-26.0	-18.7	-9.2
S22	dB	-11.0	-12.0	-12.2	-10.0	-9.5	-9.0	-9.0	-17.7
P1	dBm	18.4	18.5	18.5	18.5	18.5	18.5	17.8	15.2
OIP3	dBm	36.0	36.0	37.0	35.0	35.0	35.0	31.0	26.0
NF	dB	8.2	8.1	8.1	8.3	8.3	8.4	8.5	9.4

Typical Performance (Vc = 4.7 V, Ic = 65 mA, Ta = 25°C)

Freq	MHz	70	500	900	1900	2140	2450	3500
S21	dB	13.8	13.7	13.5	12.9	12.6	12.5	12.1
S11	dB	-10.6	-13.9	-14.0	-15.9	-16.8	-16.3	-19.0
S22	dB	-10.1	-11.8	-12.3	-11.2	-10.4	-11.8	-9.0
P1	dBm	17.0	17.0	17.0	17.2	16.8	17.2	16.7
OIP3	dBm	36.0	33.5	34.0	33.5	33.0	33.0	30.5
NF	dB	8.2	8.1	8.1	8.3	8.3	8.4	8.5

Typical Performance (Vc = 4.5 V, Ic = 58 mA, Ta = 25°C)

Freq	MHz	70	500	900	1900	2140	2450	3500
S21	dB	13.7	13.7	13.4	13.2	12.9	12.5	12.1
S11	dB	-10.8	-14.2	-14.3	-16.3	-17.2	-16.6	-19.4
S22	dB	-10.1	-11.7	-12.2	-11.1	-10.4	-11.8	-8.9
P1	dBm	16.0	15.9	15.8	15.9	15.9	16.1	15.8
OIP3	dBm	35.0	34.0	32.0	31.5	31.0	32.5	29.5
NF	dB	8.2	8.1	8.1	8.3	8.3	8.4	8.5

Typical Performance (Vc = 4 V, Ic = 41 mA, Ta = 25°C)

Freq	MHz	70	500	900	1900	2140	2450	3500
S21	dB	13.3	13.1	13.2	12.6	12.3	12.3	11.9
S11	dB	-11.7	-11.3	-15.5	-17.8	-18.9	-18.1	-21.3
S22	dB	-9.9	-11.2	-11.8	-10.8	-10.0	-11.1	-9.4
P1	dBm	12.0	11.7	11.8	12.2	11.4	12.5	12.7
OIP3	dBm	27.0	25.0	25.5	26.0	25.0	26.0	25.0
NF	dB	8.2	8.1	8.1	8.3	8.3	8.4	8.5

Typical Performance (Vc = 3.5 V, Ic = 27 mA, Ta = 25°C)

Freq	MHz	70	500	900	1900	2140	2450	3500
S21	dB	12.4	12.2	12.3	11.8	11.5	11.4	11.1
S11	dB	-14.2	-19.9	-19.5	-23.3	-25.4	-22.9	-23.9
S22	dB	-9.2	-9.9	-10.2	-9.5	-9.0	-10.0	-8.8
P1	dBm	5.0	6.2	6.2	6.4	5.7	6.7	7.8
OIP3	dBm	17.5	16.0	16.5	17.0	16.0	17.0	16.0
NF	dB	8.2	8.1	8.1	8.3	8.3	8.4	8.5

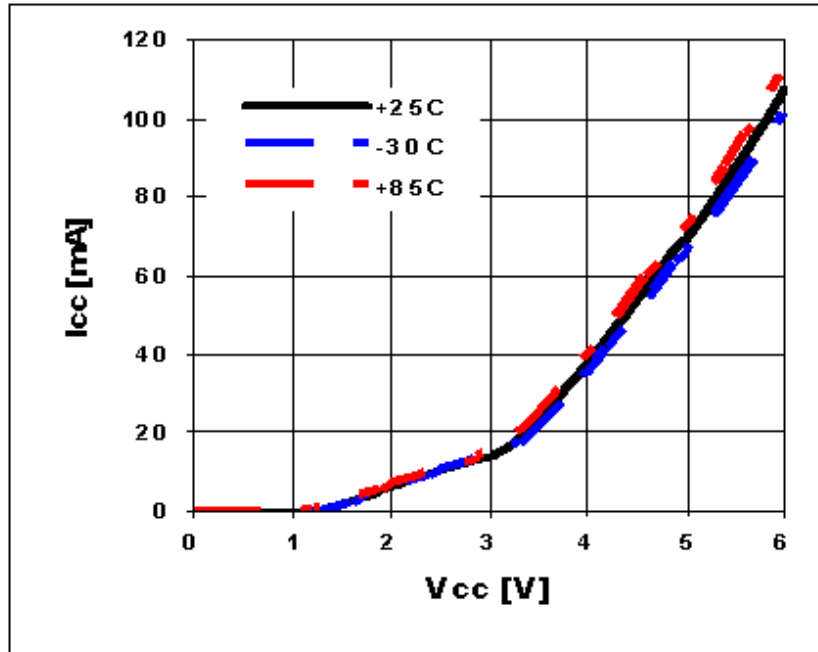
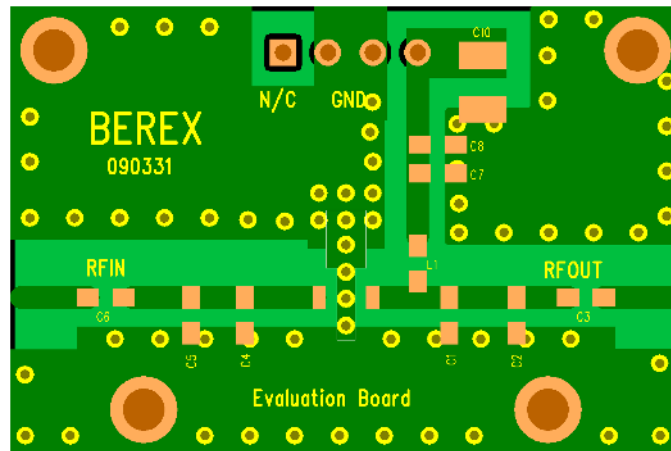
**V-I Characteristics**

**BeRex SOT89 Evaluation Board**

\*Dielectric constant\_ 4.2 \*RF pattern width 52mil \*31mil thick FR4 PCB

### Typical Device Data

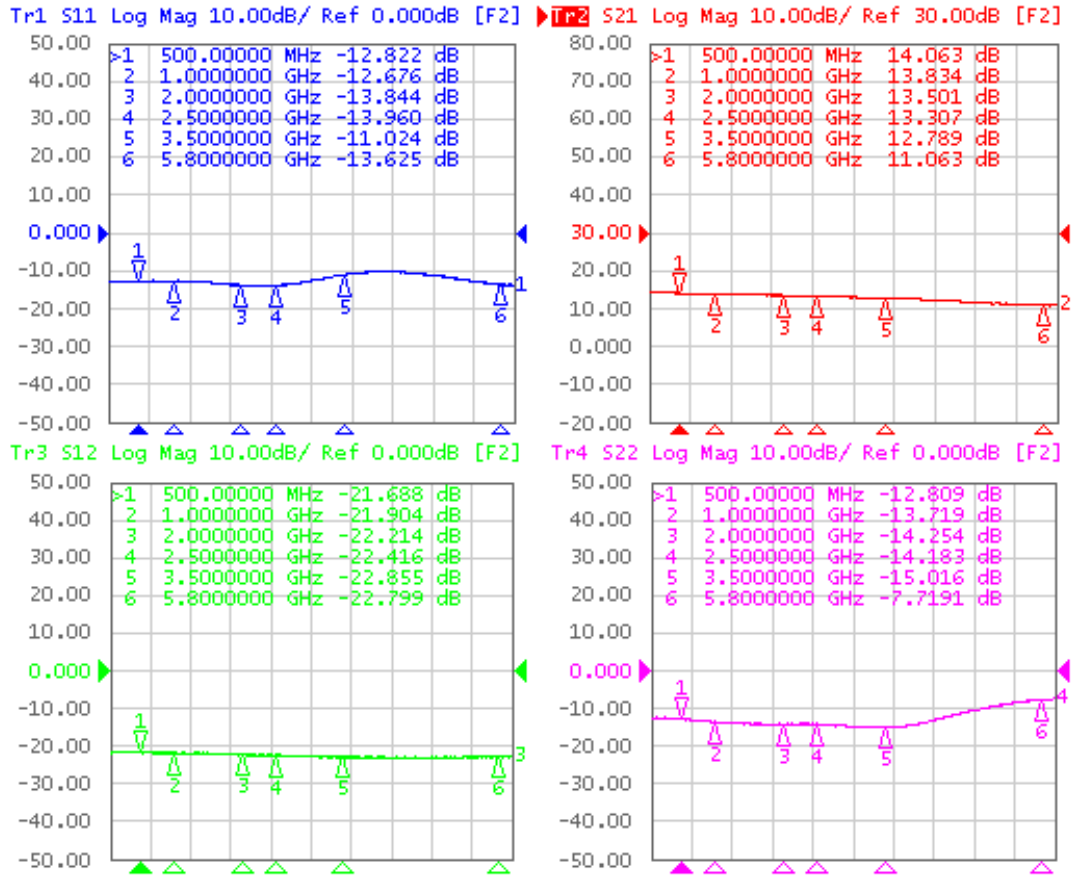
S-parameters (Vc=5V, Ic=70mA, T=25°C)



### S-Parameter

(Vdevice = 5.0V, Icc = 70mA, T = 25 °C, calibrated to device leads)

Freq [MHz]	S11 [Mag]	S11 [Ang]	S21 [Mag]	S21 [Ang]	S12 [Mag]	S12 [Ang]	S22 [Mag]	S22 [Ang]
100	0.22	175.26	5.07	176.41	0.08	-0.62	0.24	-2.00
500	0.23	158.22	5.04	162.35	0.08	-5.14	0.23	-11.59
1000	0.23	140.99	4.91	145.62	0.08	-9.81	0.21	-24.74
1500	0.22	128.51	4.79	129.51	0.08	-14.13	0.20	-40.43
2000	0.20	115.61	4.73	113.63	0.08	-18.70	0.19	-58.69
2500	0.20	100.95	4.63	97.25	0.08	-22.67	0.19	-78.28
3000	0.23	90.07	4.45	81.82	0.07	-28.35	0.18	-98.70
3500	0.28	84.48	4.36	66.63	0.07	-31.03	0.18	-123.68
4000	0.30	84.97	4.18	51.53	0.07	-34.90	0.20	-148.73
6000	0.20	106.47	3.52	-6.78	0.07	-51.53	0.42	-171.24

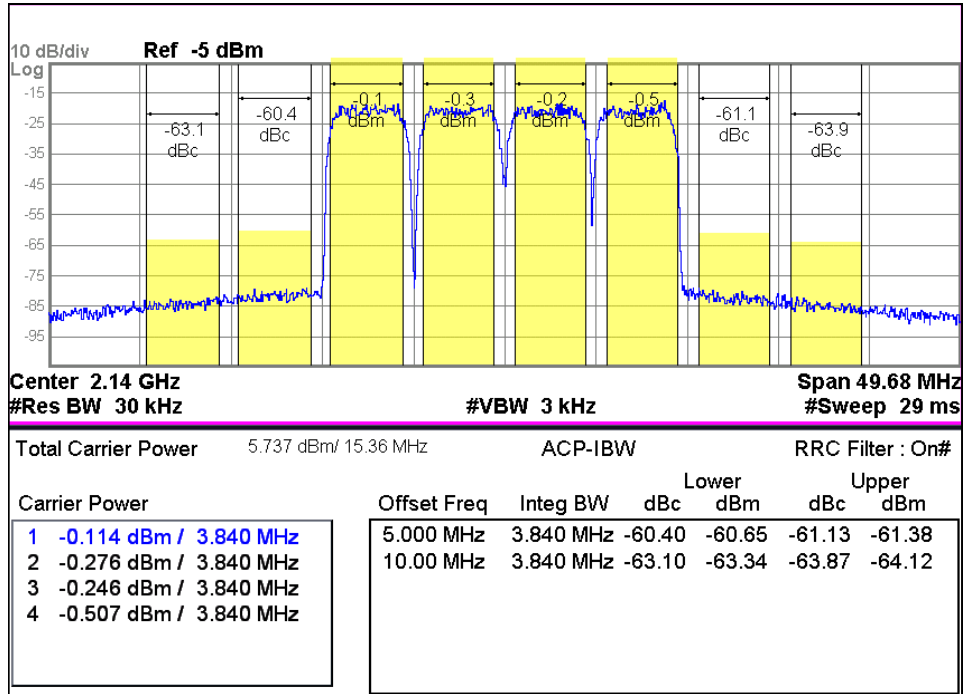
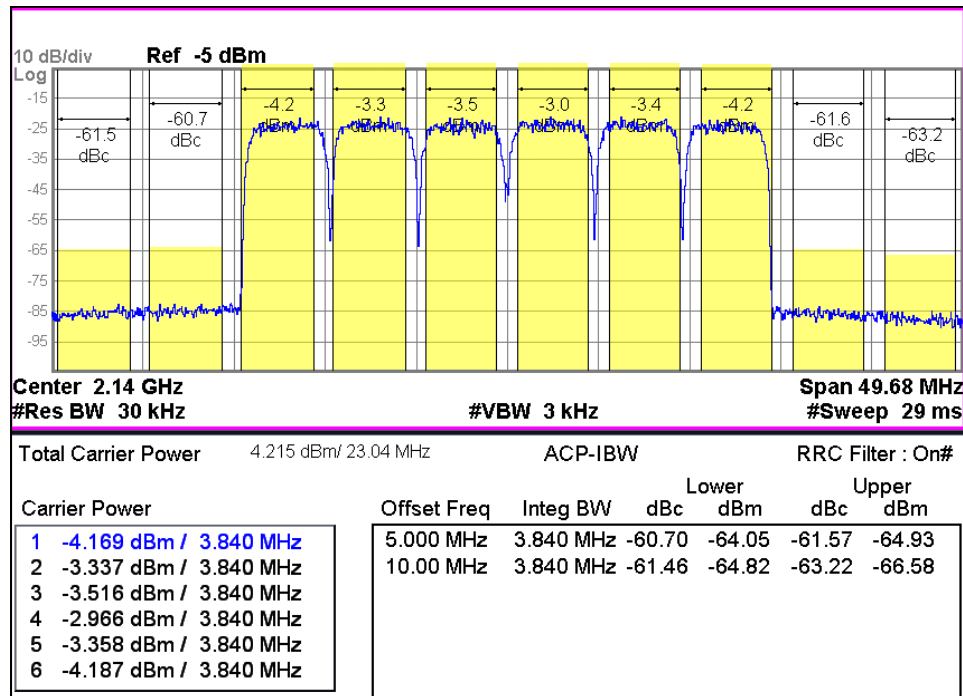
**WCDMA 4FA 2140 -60dBc**

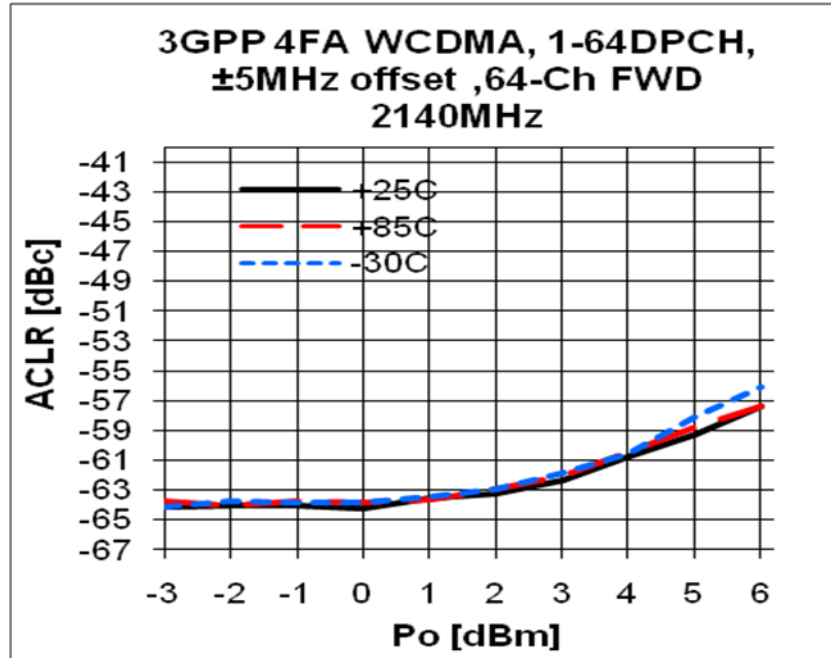
**WCDMA 6FA 2140 -60dBc**

**ACLR**

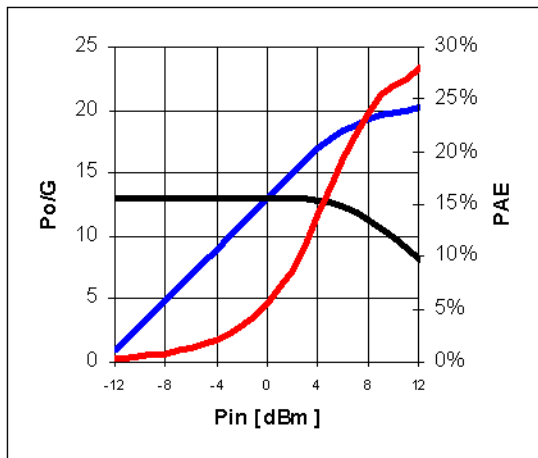
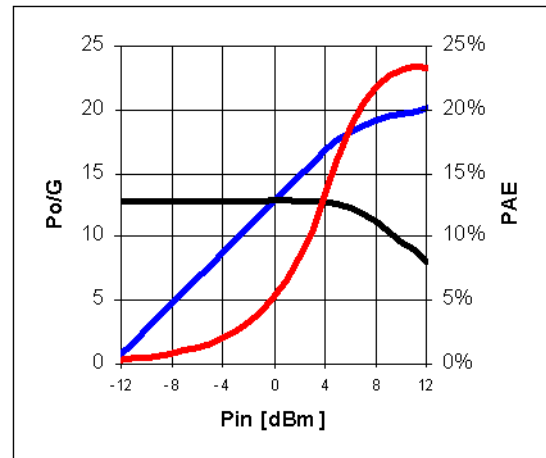
**Typical Performance**  
 (Vc=5V, Ic=70mA, T=25°C)

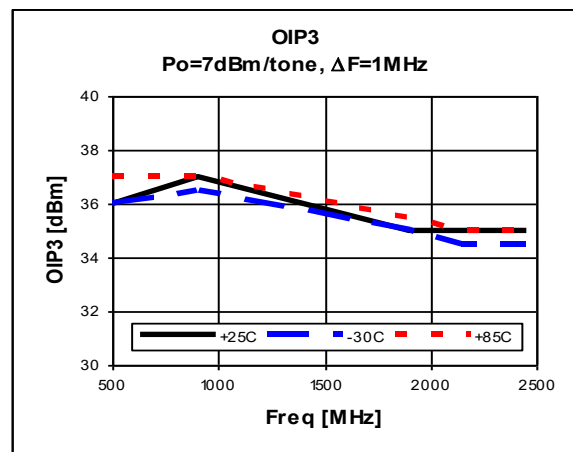
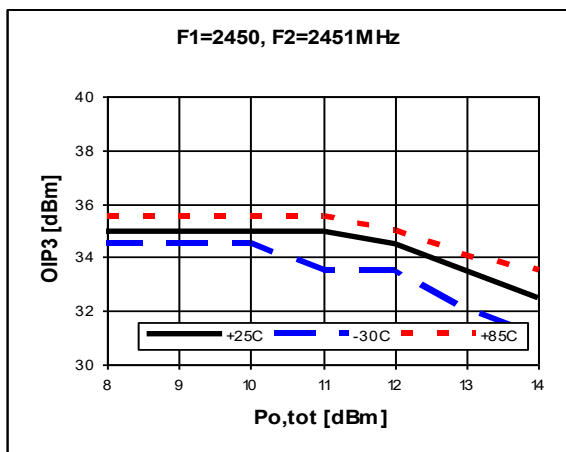
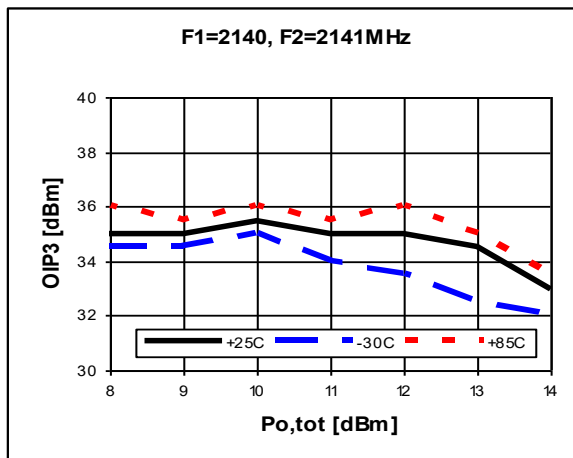
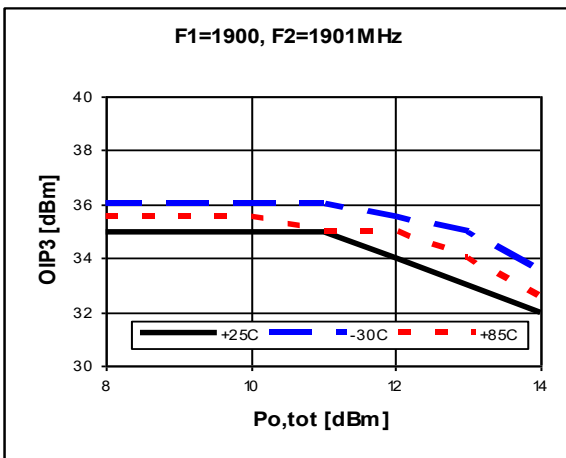
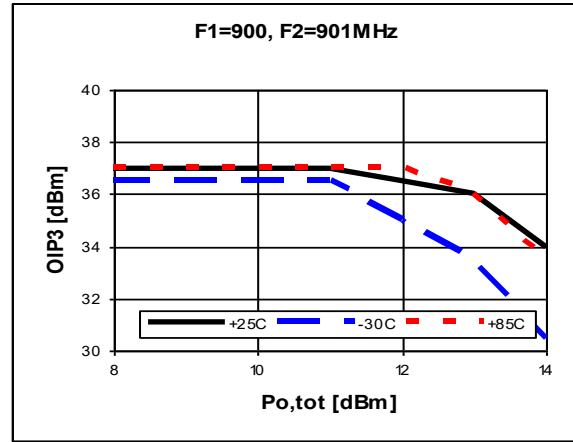
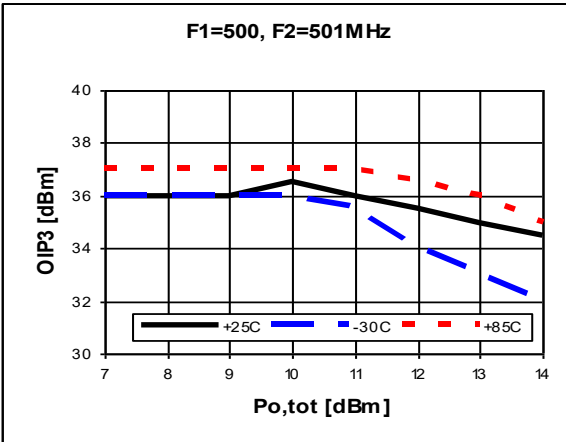
## Pin-Pout-Gain

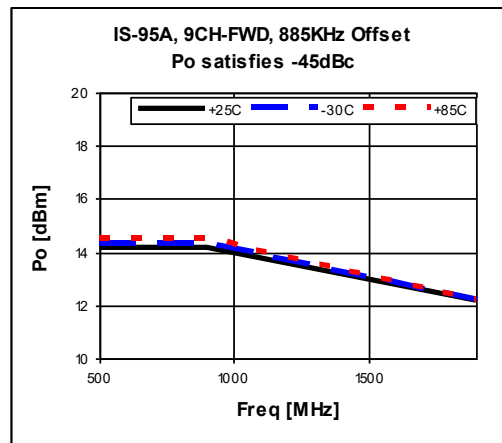
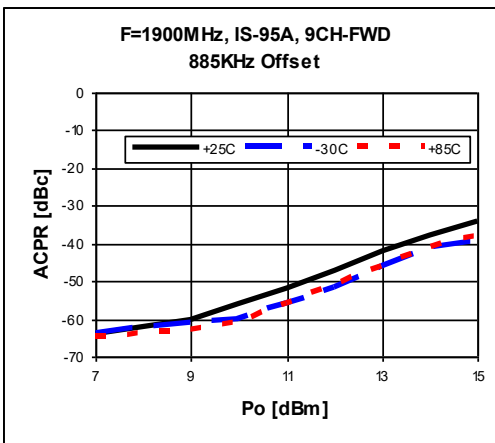
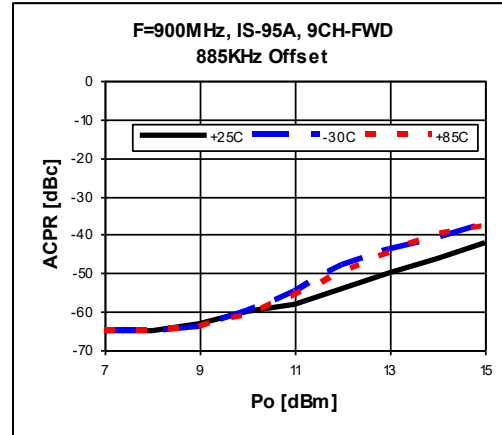
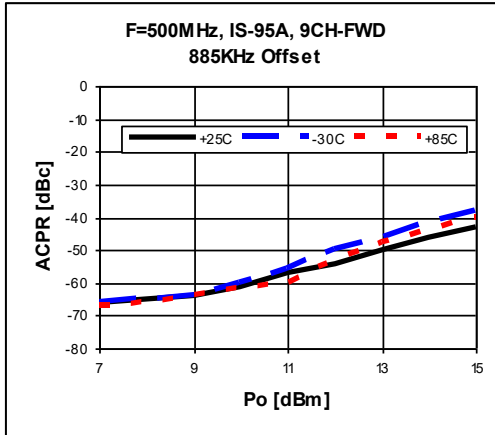
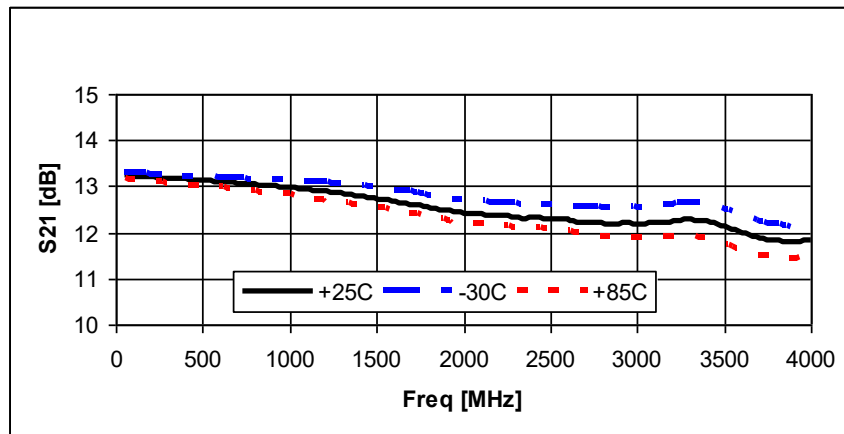

**900MHz**

**1900 MHz**

**OIP3**

**ACPR**

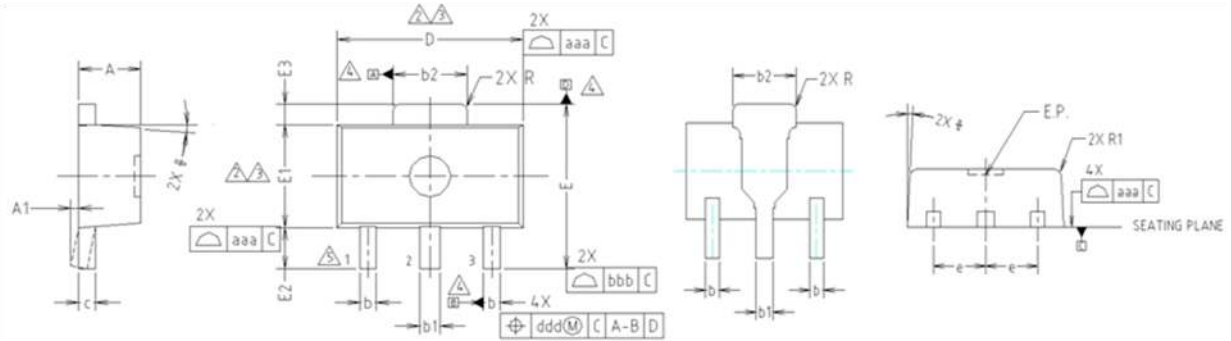
**Gain Flatness**



### Package Outline Dimension



- NOTE:**  
 1. DIMENSIONS IN MILLIMETERS.
- ⚠ DIMENSION D DOES NOT INCLUDE MOLD FLASH, PROTRUSIONS OR GATE BURRS. MOLD FLASH, PROTRUSIONS OR GATE BURRS SHALL NOT EXCEED 0.5mm PER END. DIMENSION E1 DOES NOT INCLUDE INTERLEAD FLASH OR PROTRUSION. INTERLEAD FLASH OR PROTRUSION SHALL NOT EXCEED 0.5mm PER SIDE.
  - ⚠ DIMENSIONS D AND E1 ARE DETERMINED AT THE OUTMOST EXTREMES OF THE PLASTIC BODY EXCLUSIVE OF MOLD FLASH, TIE BAR BURRS, GATE BURRS AND INTERLEAD FLASH, BUT INCLUDING ANY MISMATCH BETWEEN THE TOP AND BOTTOM OF THE PLASTIC BODY.
  - ⚠ DATUMS A, B AND D TO BE DETERMINED 0.18mm FROM THE LEAD TIP.
  - ⚠ TERMINAL NUMBERS ARE SHOWN FOR REFERENCE ONLY.

SYMBOL	MILLIMETERS			NOTE
	MINIMUM	NOMINAL	MAXIMUM	
A	1.40	1.50	1.60	
A1	0.00	—	0.10	
b	0.38	0.42	0.48	
b1	0.48	0.52	0.58	
b2	1.79	1.82	1.87	
c	0.40	0.42	0.46	
D	4.40	4.50	4.70	2,3
E	3.70	4.00	4.30	
E1	2.40	2.50	2.70	2,3
E2	0.80	1.00	1.20	
E3	0.40	0.50	0.60	
e	1.50 TYP.			
φ	4° TYP.			
R	0.15 TYP.			
R1	—			0.20
SYMBOL	TOLERANCES OF FORM AND POSITION		NOTE	
aaa	0.15			
bbb	0.20			
ccc	0.10			
ddd	0.10			

### Suggested PCB Land Pattern and PAD Layout

**PCB Land Pattern**

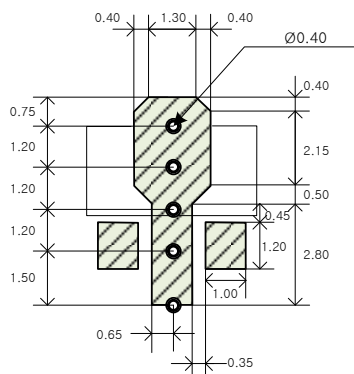

**PCB Mounting**

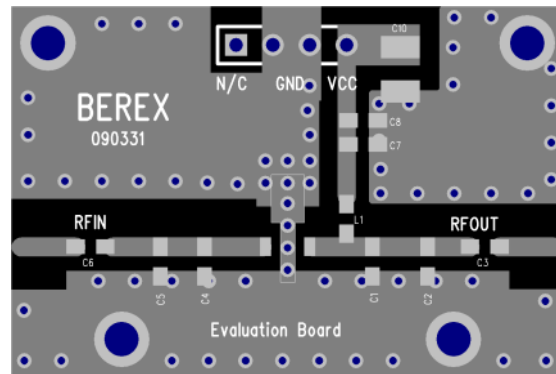

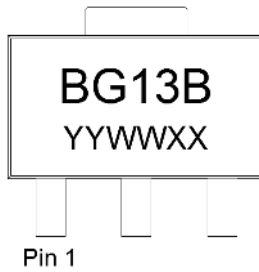
**Package Marking**

YY = Year, WW = Working Week,  
XX = Wafer No.

**Tape & Reel**

SOT89

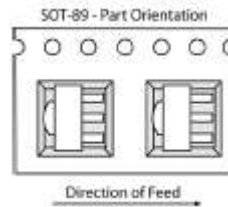

Packaging information:

Tape Width (mm): 12  
Reel Size (inches): 7  
Device Cavity Pitch (mm): 8  
Devices Per Reel: 1000

**Lead plating finish**

100% Tin Matte finish

(All BeRex products undergoes a 1 hour, 150 degree C, Anneal bake to eliminate thin whisker growth concerns.)

**MSL / ESD Rating**

<b>ESD Rating:</b>	Class 1C
<b>Value:</b>	<b>Passes &lt;2000V</b>
<b>Test:</b>	Human Body Model (HBM)
<b>Standard:</b>	JEDEC Standard JESD22-A114
<b>MSL Rating:</b>	<b>Level 1 at +260°C convection reflow</b>
<b>Standard:</b>	JEDEC Standard J-STD-020



Proper ESD procedures should be followed when handling this device.

**RoHS Compliance**

This part is compliant with Restrictions on the Use of Certain Hazardous Substances in Electrical and Electronic Equipment (RoHS) Directive 2011/65/EU as amended by Directive 2015/863/EU.

This product also is compliant with a concentration of the Substances of Very High Concern (SVHC) candidate list which are contained in a quantity of less than 0.1%(w/w) in each components of a product and/or its packaging placed on the European Community market by the BeRex and Suppliers.

**NATO CAGE code:**

2	N	9	6	F
---	---	---	---	---