

SF2289C

**155 MHz
SAW Filter**

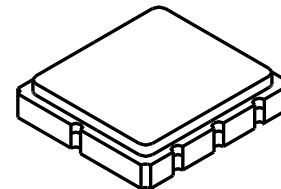

SM5050-8

- **Low Loss SAW Filter**
- **5.0 x 5.0 mm Surface-mount Case**
- **Complies with Directive 2002/95/EC (RoHS)**
- **Moisture Sensitivity Level: 1**

Absolute Maximum Ratings

Rating	Value	Units
Maximum Incident Power in Passband	10	dBm
Maximum DC Voltage on any Non-ground Terminal	10	V
Storage Temperature Range in Tape and Reel	-40 to +85	°C
Maximum Soldering Profile	265 °C for 10 s	

Electrical Characteristics

Characteristic	Sym	Notes	Min	Typ	Max	Units
Center Frequency	f_C			155		MHz
Insertion Loss, $f_C \pm 4$ MHz	IL				6.5	dB
Rejection Referenced to 0dB:						dB
$f_C - 38.8$ to $f_C - 100$ MHz			50			
$f_C + 38.8$ to $f_C + 100$ MHz			42			
Operating Temperature Range	T_A		-40		+50	°C
Input Impedance at f_C			263 Ω 8.7 pF			
Output Impedance at f_C			685 Ω 9.1 pF			
Case Style			SM5050-8 5 x 5 mm Nominal Footprint			
Lid Symbolization (Y = year, WW = week, S = shift)			A36, YWWS			

50 ohm Matching Network

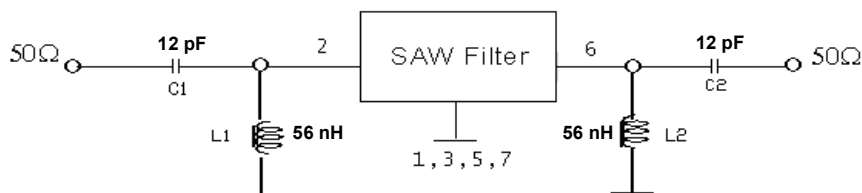

CAUTION: Electrostatic Sensitive Device. Observe precautions for handling.

NOTES:

1. The design, manufacturing process, and specifications of this device are subject to change.
2. US or International patents may apply.
3. RoHS compliant from the first date of manufacture.

Filter Broadband Plot

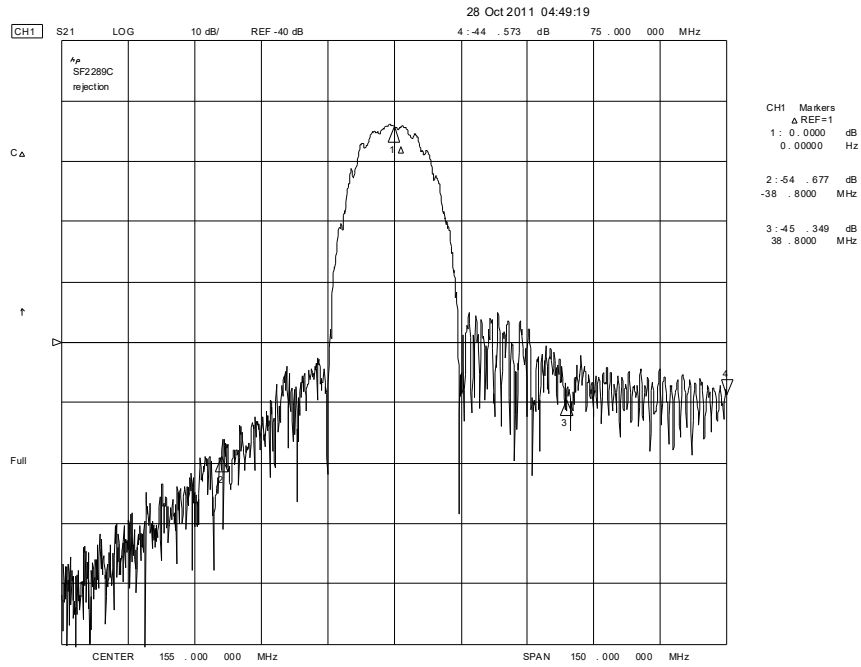

Filter Impedance and Passband Plot

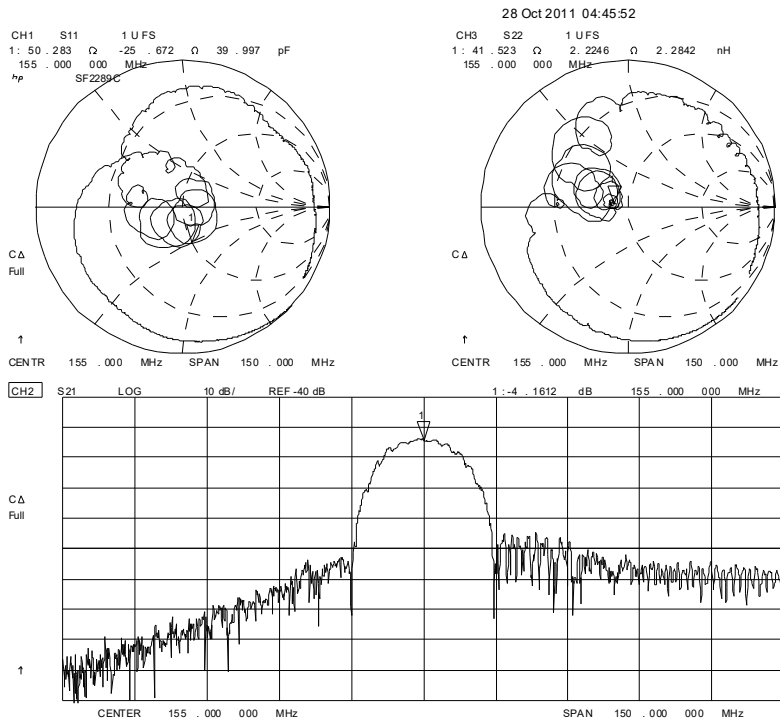

SM5050-8 Surface-Mount 8-Terminal Ceramic Case 5.0 X 5.0 mm Nominal Footprint

Case Dimensions

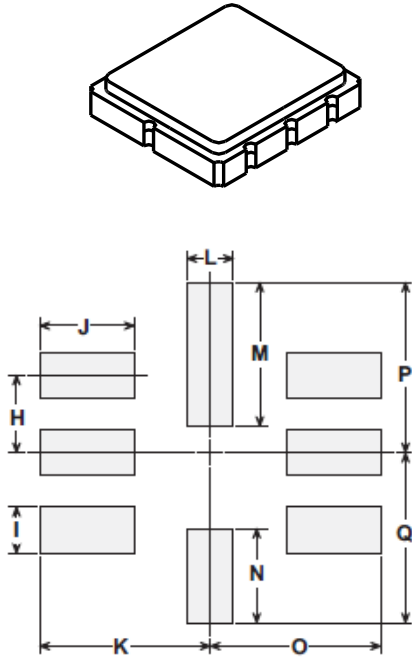

PCB Footprint

Dimension	mm			Inches		
	Min	Nom	Max	Min	Nom	Max
A	4.80	5.00	5.20	0.189	0.197	0.205
B	4.80	5.00	5.20	0.189	0.197	0.205
C	1.30	1.50	1.70	0.050	0.060	0.067
D	1.98	2.08	2.18	0.078	0.082	0.086
E	1.07	1.17	1.27	0.042	0.046	0.050
F	0.50	0.64	0.70	0.020	0.025	0.028
G	2.39	2.54	2.69	0.094	0.100	0.106
H		1.27			0.050	
I		0.76			0.030	
J		1.55			0.061	
K		2.79			0.110	
L		0.76			0.030	
M		2.36			0.093	
N		1.55			0.061	
O		2.79			0.110	
P		2.79			0.110	
Q		2.79			0.110	

Case Materials

Materials	
Solder Pad Plating	0.3 to 1.0 μm Gold over 1.27 to 8.89 μm Nickel
Lid Plating	2.0 to 3.0 μm Nickel
Body	Al_2O_3 Ceramic

Electrical Connections

Connection		Terminals
Port 1	Input	2
Port 2	Output	6
	Ground	All others
Dot indicates Pin 1		

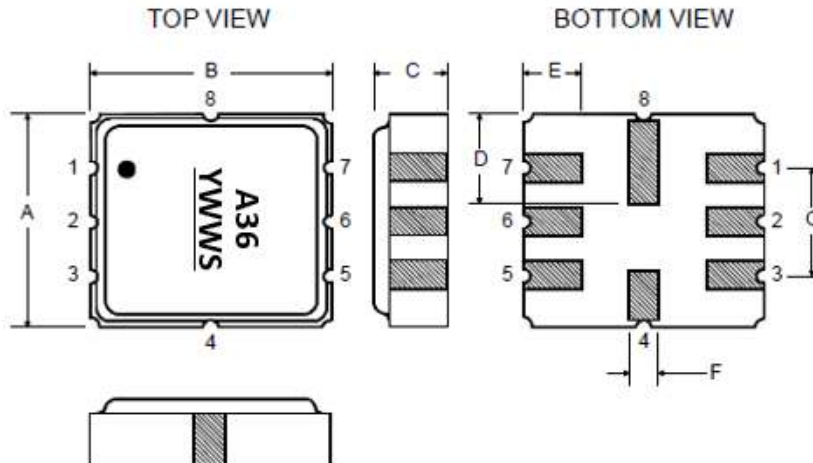

Tape and Reel Specifications

Tape and Reel Standard per ANSI/EIA-481

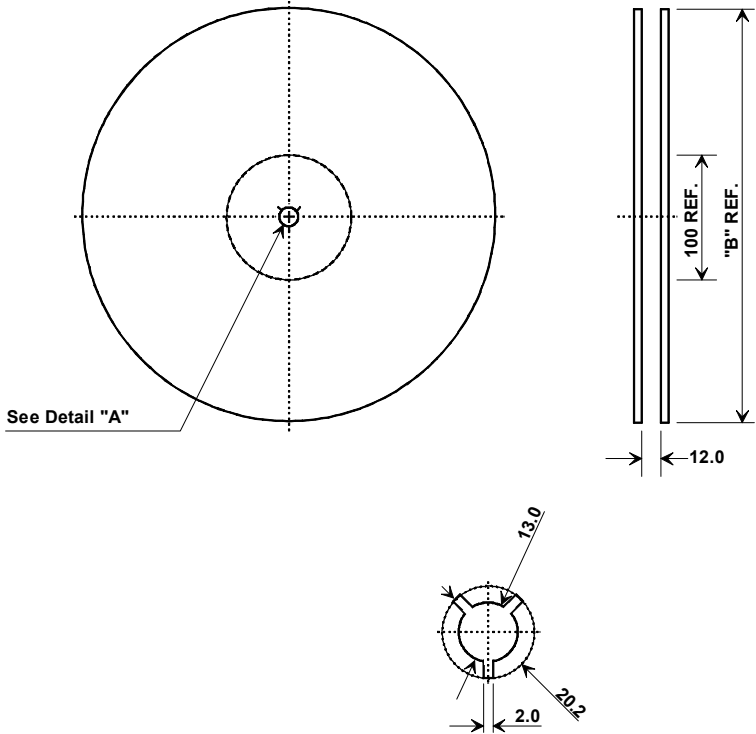

"B" Nominal Size		Quantity Per Reel
Inches	millimeters	
7	178	500
13	330	3000

COMPONENT ORIENTATION and DIMENSIONS

Carrier Tape Dimensions	
Ao	5.3 mm
Bo	5.3 mm
Ko	2.0 mm
Pitch	8.0 mm
W	12.0 mm

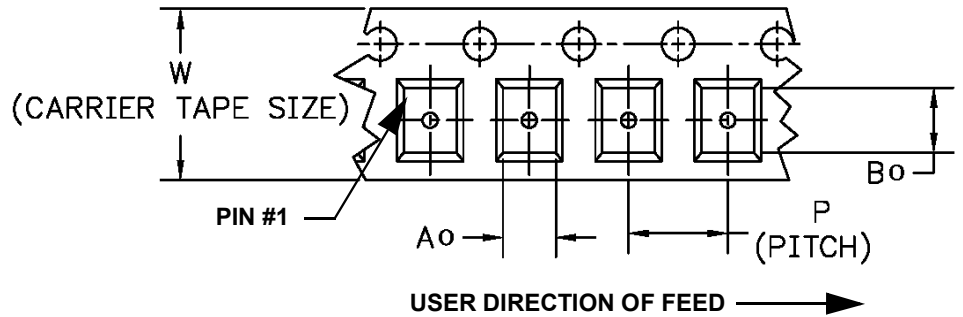
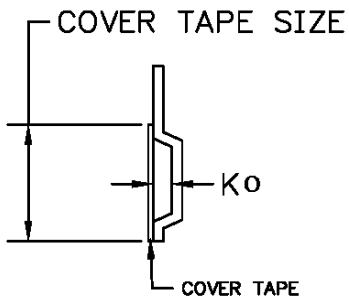

Recommended Reflow Profile

1. Preheating shall be fixed at 150~180°C for 60~90 seconds.
2. Ascending time to preheating temperature 150°C shall be 30 seconds min.
3. Heating shall be fixed at 220°C for 50~80 seconds and at 260°C +0/-5°C peak (10 seconds).
4. Time: 5 times maximum.

