

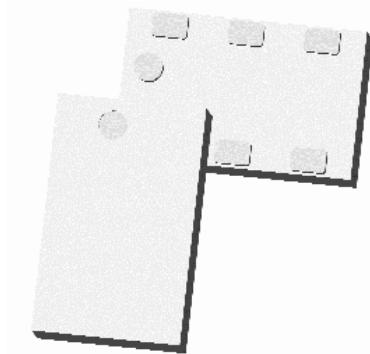

**Ultra Low Profile 0805  
Impedance Transformer  
50Ω to 12.5Ω**



**Description:**

The T0727J5012AHF is a low cost, low profile sub-miniature impedance transformer in an easy to use surface mount package. With smaller footprint, this single component replaces the conventional discrete component matching network for the full LTE communication band 700 MHz–2700 MHz. The T0727J5012AHF delivers high performance, superior consistency, and reliability. The T0727J5012AHF is available on tape and reel and is ideal for pick and place high volume manufacturing.

**Detailed Electrical Specifications:**

Specifications subject to change without notice.

**Features:**

- 700 – 2700 MHz
- 0.84 mm Height Profile
- 50 Ohm to 12.5 Ohm
- Low Insertion Loss
- Designed for LTE applications
- Surface Mountable
- Tape & Reel
- Non-conductive Surface
- RoHS Compliant
- Halogen Free

| Parameter             | ROOM (25°C) |      |      | Unit  |
|-----------------------|-------------|------|------|-------|
|                       | Min.        | Typ. | Max  |       |
| Frequency             | 700         |      | 2700 | MHz   |
| Input Port Impedance  |             | 50   |      | Ω     |
| Output Port Impedance |             | 12.5 |      | Ω     |
| Return Loss           | 15          | 19   |      | dB    |
| Insertion Loss*       |             | 0.6  | 0.9  | dB    |
| Power Handling        |             |      | 1    | Watts |
| Operating Temperature | -55         |      | +85  | °C    |

\*Insertion Loss stated with tuning capacitors. Insertion Loss stated at room temperature (Insertion Loss is approximately 0.1 dB higher at +85 °C)

**Outline Drawing:**

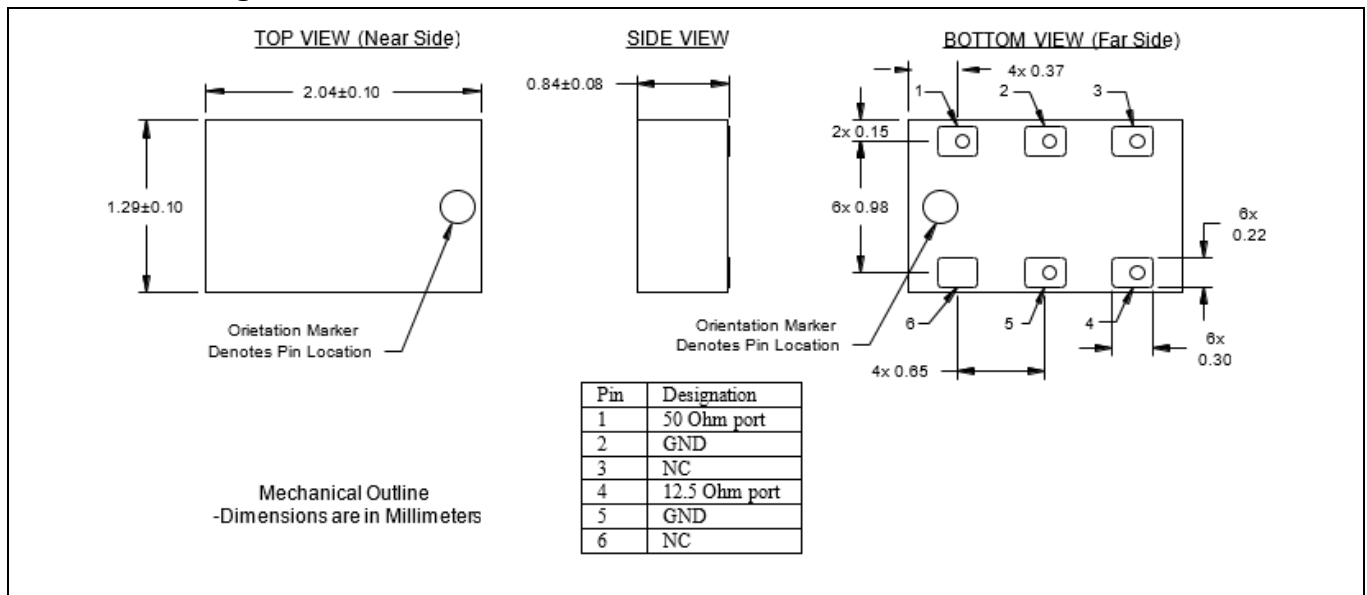

**Typical Performance 50 Ohm to 12.5 Ohm: 600MHz-2800MHz:**

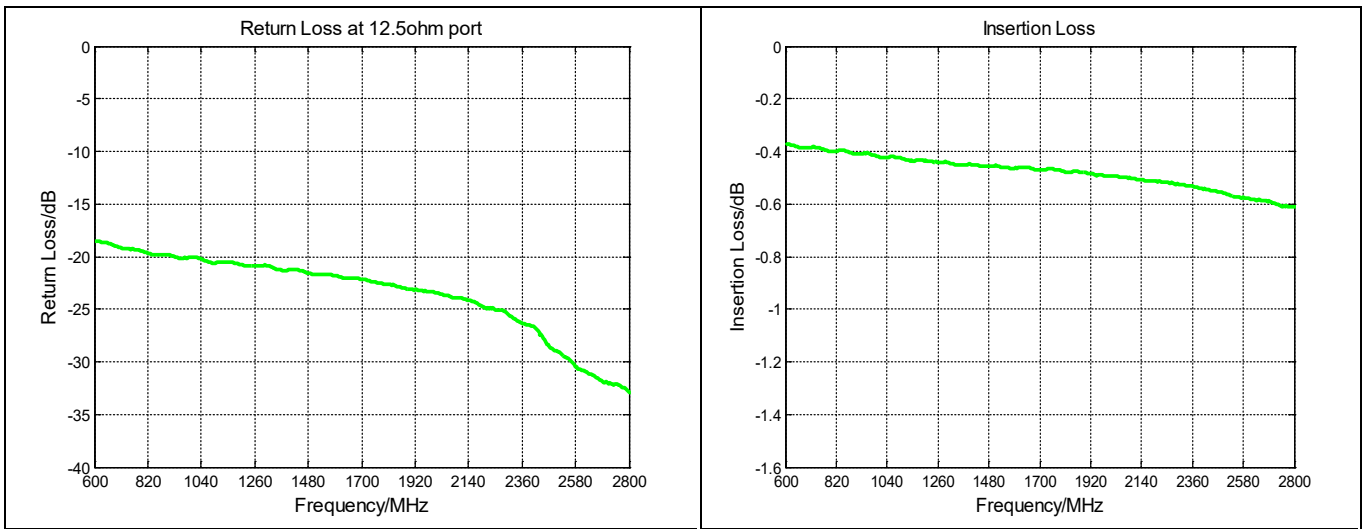
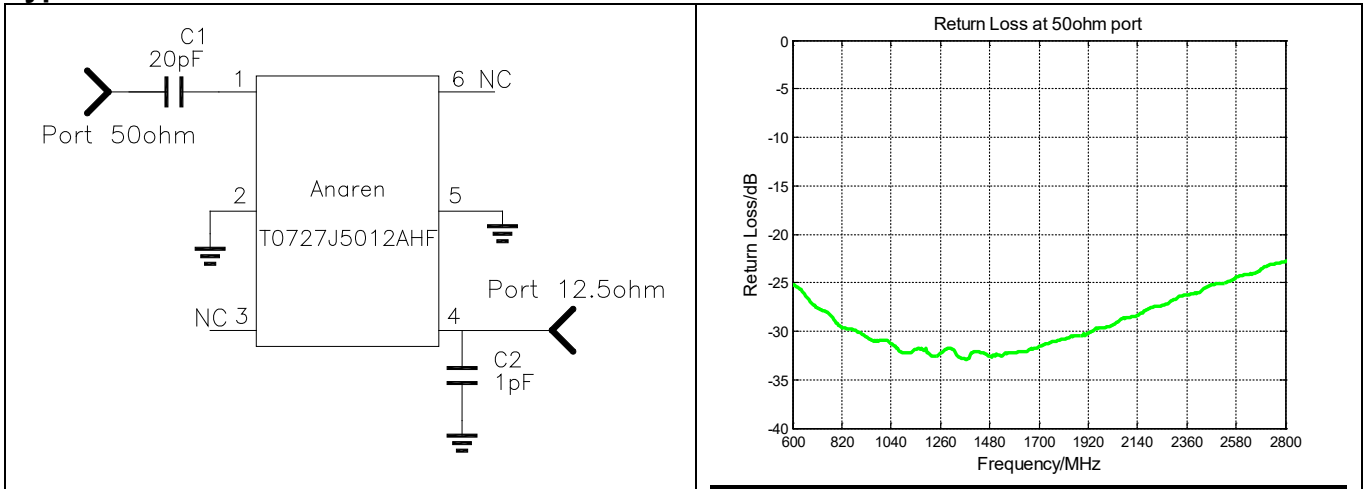

DC connectivity of T0727J5012AHF with pin assignments is shown below. It is noted here that pin3 and pin6 are NC pins without any internal connections, while pin1, pin4, pin 2 and pin 5 are DC connected internally together. To have T0727J5012AHF function properly, pin 2 and pin 5 are required to be grounded by the mounting footprint.

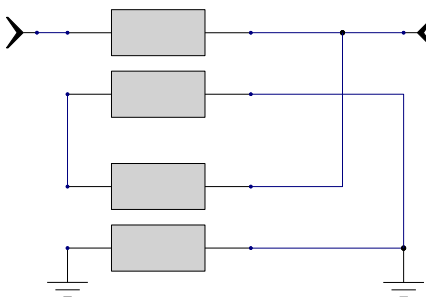

**Typical Performance 50 Ohm to 3 Ohm: 600MHz-2800MHz:**

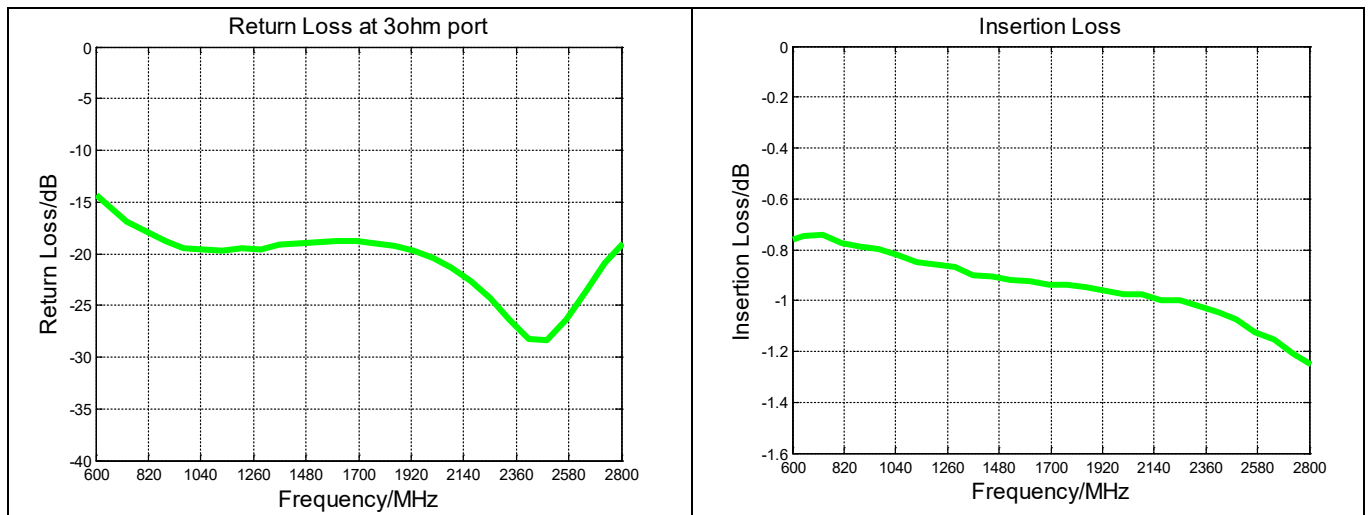
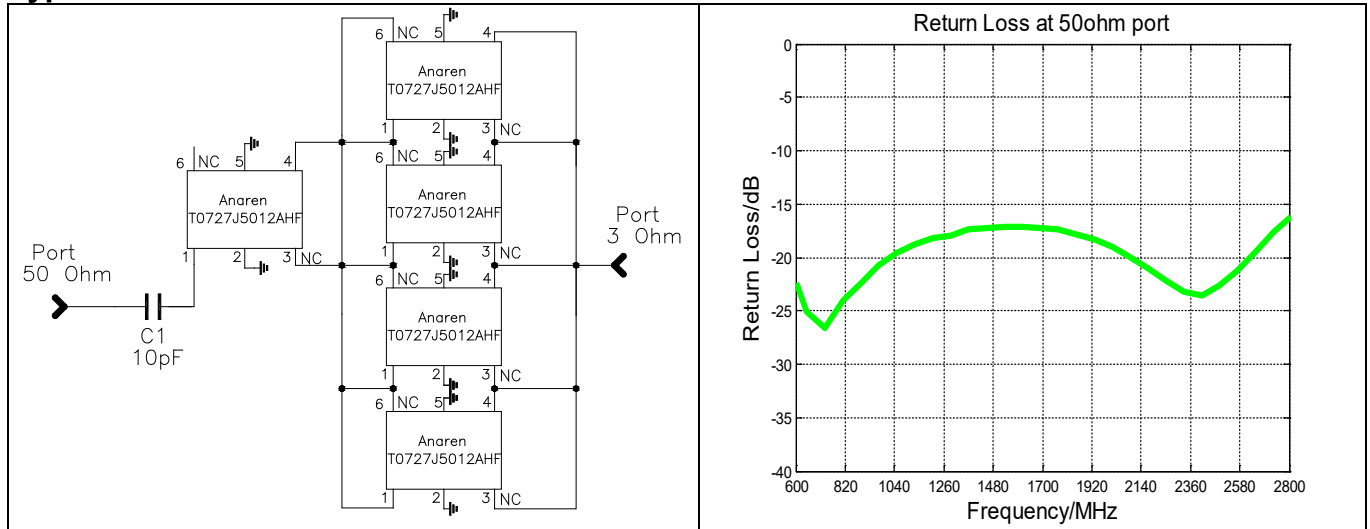

Above schematic is to demonstrate how to convert the 50 Ohm to 3 Ohm using T0727J5012AHF. Paralleling four parts of T0727J5012AHF results in the impedance conversion of 12.5 Ohm to 3 Ohm. Cascading another T0727J5012AHF in series provides a total impedance conversion of 50 Ohm to 3 Ohm. An illustrative mounting configuration is shown below. It's noted that the NC pins (pin 3 and pin 6) are connected with the adjacent pins (pin 4 and pin 1) to provide the wide line connection required for the low impedance. Depending on the mounting substrate and frequency band of application, the value of tuning capacitor may be further optimized.

### Mounting Configuration 50 Ohm to 12.5 Ohm:

In order for Xinger surface mount components to work optimally, the proper impedance transmission lines must be used to connect to the RF ports. If this condition is not satisfied, insertion loss, Isolation and VSWR may not meet published specifications.

All of the Xinger components are constructed from organic PTFE based composites which possess excellent electrical and mechanical stability. Xinger components are compliant to a variety of ROHS and Green standards and ready for Pb-free soldering processes. Pads are Gold plated with a Nickel barrier.

Series capacitor C1 at pin 1 and shunt capacitor C2 at pin 4 are required to get the optimum performance. All the input and output pins are DC connected internally together with RF grounds pins. DC bias can be applied through appropriate RF choke and DC blocking capacitor.

An example of the PCB footprint used in the testing of these parts is shown below. In specific designs, the transmission line widths need to be adjusted to the unique dielectric coefficients and thicknesses as well as varying pick and place equipment tolerances.

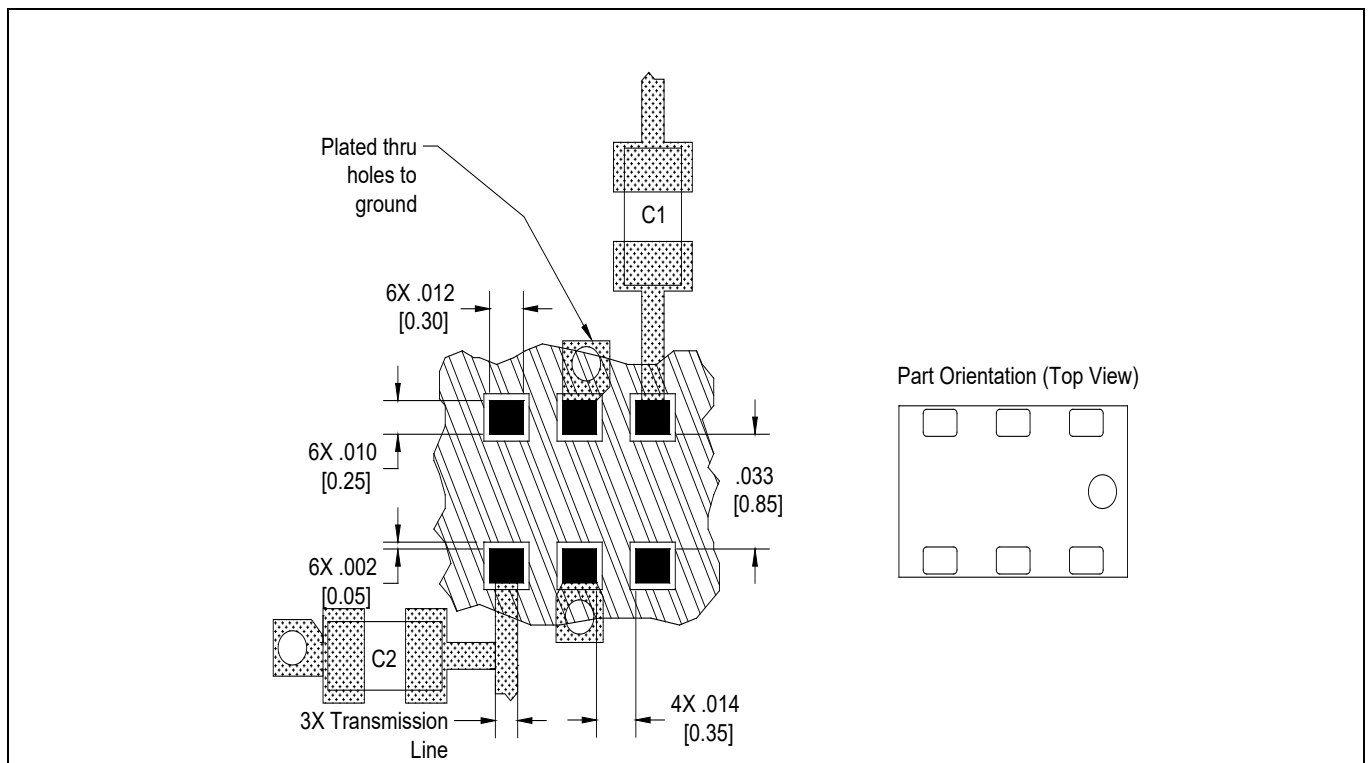

### Mounting Configuration 50 Ohm to 3 Ohm:

For the 50 ohm to 3 ohm configuration, a total of five (5) T0727J5012AHFs and a series capacitor C1 at pin 1 of the input transformer are required to get the optimum performance.

An example of the PCB footprint used in the testing of these parts is shown below. In specific designs, the transmission line widths may need to be adjusted to the unique dielectric coefficients and thickness.

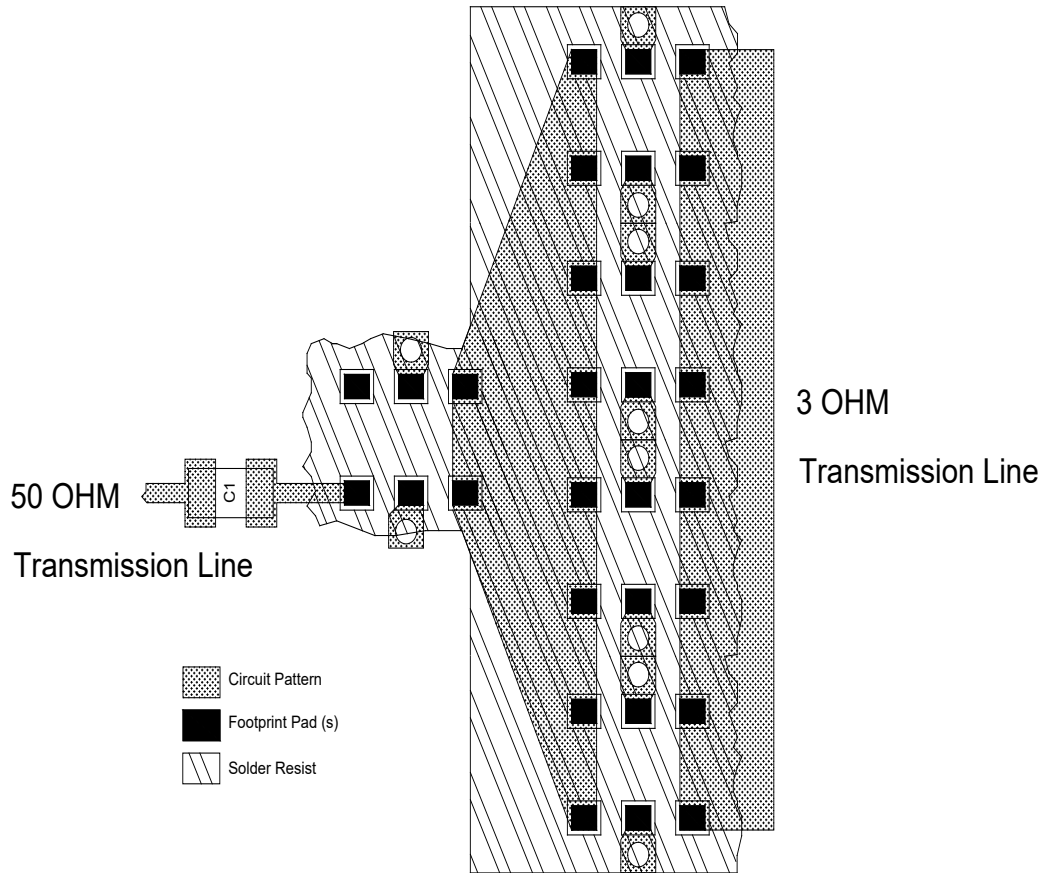

**Packaging and Ordering Information:**

Parts are available in reel and are packaged per EIA 481-D. Parts are oriented in tape and reel as shown below. Minimum order quantities are 4000 per reel.

