



ET3-E3228

ELF3

CYLINDRICAL PHOTOELECTRIC SENSORS

SICK
Sensor Intelligence.



Illustration may differ



Ordering information

Type	Part no.
ET3-E3228	1045212

Other models and accessories → www.sick.com/ELF3

Detailed technical data

Features

Functional principle	Photoelectric proximity sensor
Functional principle detail	Background suppression
Dimensions (W x H x D)	23.8 mm x 43.4 mm x 33.6 mm
Housing design (light emission)	Hybrid
Thread diameter (housing)	M18
Sensing range max.	0 mm ... 50 mm ¹⁾
Sensing range	0 mm ... 50 mm ¹⁾
Type of light	Infrared light
Light source	LED ²⁾
Light spot size (distance)	10.5 mm x 10.5 mm (50 mm)
Wave length	880 nm
Adjustment	None

¹⁾ Object with 90% remission (based on standard white, DIN 5033).

²⁾ Average service life: 100,000 h at T_U = +25 °C.

Mechanics/electronics

Supply voltage	10 V DC ... 30 V DC ¹⁾
Ripple	< 5 V _{pp} ²⁾
Current consumption	20 mA ³⁾
Switching output	NPN

¹⁾ Limit values.

²⁾ May not exceed or fall below U_v tolerances.

³⁾ Without load.

⁴⁾ With light/dark ratio 1:1.

⁵⁾ A = V_S connections reverse-polarity protected.

⁶⁾ D = outputs overcurrent and short-circuit protected.

⁷⁾ Reference voltage: 50 V DC.

Switching mode	Dark switching
Output current I_{max}	≤ 50 mA
Switching frequency	200 Hz ⁴⁾
Connection type	Male connector M12, 4-pin
Circuit protection	A ⁵⁾ D ⁶⁾
Protection class	III ⁷⁾
Weight	+ 0.014 kg, + 0.03 lbs
Housing material	Plastic, Glass fiber reinforced ABS plastic
Enclosure rating	IP67
Items supplied	Mounting nut M18
Ambient operating temperature	-25 °C ... +50 °C
Ambient temperature, storage	-40 °C ... +70 °C

¹⁾ Limit values.

²⁾ May not exceed or fall below U_v tolerances.

³⁾ Without load.

⁴⁾ With light/dark ratio 1:1.

⁵⁾ A = V_S connections reverse-polarity protected.

⁶⁾ D = outputs overcurrent and short-circuit protected.

⁷⁾ Reference voltage: 50 V DC.

Classifications

eCl@ss 5.0	27270903
eCl@ss 5.1.4	27270903
eCl@ss 6.0	27270903
eCl@ss 6.2	27270903
eCl@ss 7.0	27270903
eCl@ss 8.0	27270903
eCl@ss 8.1	27270903
eCl@ss 9.0	27270903
eCl@ss 10.0	27270904
eCl@ss 11.0	27270904
eCl@ss 12.0	27270903
ETIM 5.0	EC001821
ETIM 6.0	EC001821
ETIM 7.0	EC002719
ETIM 8.0	EC002719
UNSPSC 16.0901	39121528

Connection type

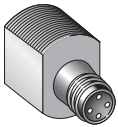

Connection diagram

Cd-066

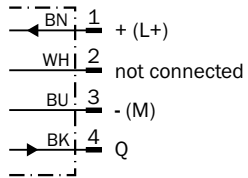

Sensing range diagram

ET3, ET4, 50 mm

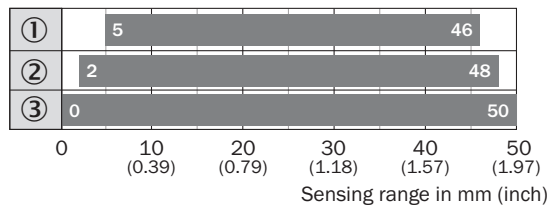

- ① Sensing range on black, 6% remission
- ② Sensing range on gray, 18 % remission
- ③ Sensing range on white, 90% remission

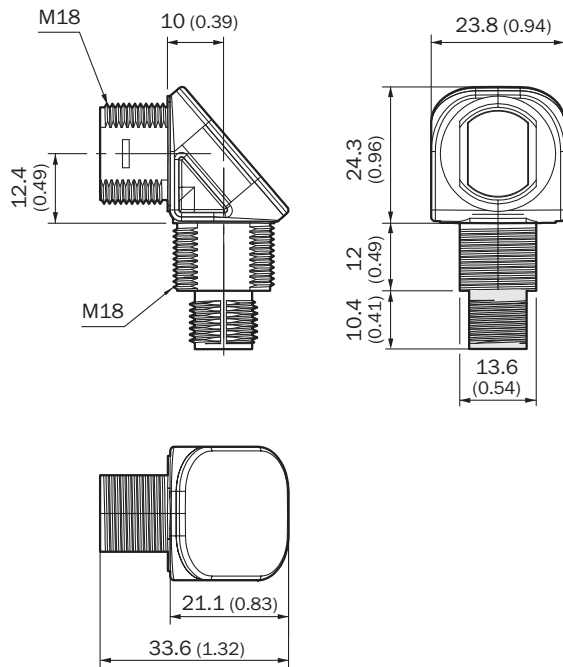

Dimensional drawing (Dimensions in mm (inch))

ET3, EL3, connector M12



Recommended accessories

Other models and accessories → www.sick.com/ELF3

	Brief description	Type	Part no.
Mounting brackets and plates			
	Mounting bracket for M18 sensors, steel, zinc coated, without mounting hardware	BEF-WN-M18	5308446
Plug connectors and cables			
	Head A: female connector, M12, 4-pin, straight, A-coded Head B: Flying leads Cable: Sensor/actuator cable, PVC, unshielded, 5 m	YF2A14-050VB3XLEAX	2096235
	Head A: male connector, M12, 4-pin, straight Cable: unshielded	STE-1204-G	6009932

SICK AT A GLANCE

SICK is one of the leading manufacturers of intelligent sensors and sensor solutions for industrial applications. A unique range of products and services creates the perfect basis for controlling processes securely and efficiently, protecting individuals from accidents and preventing damage to the environment.

We have extensive experience in a wide range of industries and understand their processes and requirements. With intelligent sensors, we can deliver exactly what our customers need. In application centers in Europe, Asia and North America, system solutions are tested and optimized in accordance with customer specifications. All this makes us a reliable supplier and development partner.

Comprehensive services complete our offering: SICK LifeTime Services provide support throughout the machine life cycle and ensure safety and productivity.

For us, that is “Sensor Intelligence.”

WORLDWIDE PRESENCE:

Contacts and other locations www.sick.com