

Power Management LSI Series for Automotive Body Control

Regulators with Voltage Detector and Watchdog Timer

BD3004HFP, BD3005HFP



●Description

The BD3004HFP, BD3005HFP low bias current regulator and watchdog timer features a high 50 V breakdown voltage and is compatible with on-board vehicle microcontrollers. It offers an output current of 500 mA while limiting bias current to 80 μ A (Typ.). The series supports the use of ceramic capacitors as output phase compensation capacitors. The reset detection voltage can be changed by connecting a resistor to the Vs pin. (BD3004HFP) The watchdog timer can be switched on and off using the INH pin input logic. (BD3005HFP)

●Features

- 1) 5 V/500 mA regulators for microcontrollers
 BD3004HFP: Adjustable detection voltage (Vs pin)
 BD3005HFP: Built-in watchdog timer reset circuit (INH pin: watchdog timer on/off)
- 2) Super-low bias current: 80 μ A (Typ.)
- 3) Low-saturation voltage type P-channel DMOS output transistors
- 4) High precision output voltage: 5 V \pm 2%
- 5) Low-ESR ceramic capacitors can be used as output capacitors
- 6) Vcc Maximum applied voltage: 50 V
- 7) Built-in overcurrent protection circuit and thermal shutdown circuit
- 8) Built-in reverse connection breakdown prevention circuit
- 9) Back current flow protection during sudden battery failures, making it a highly reliable 5 V regulator.
- 10) HRP7 package

●Applications

Onboard devices (Vehicle equipment, Car stereos, Satellite navigation systems, etc.)

●Absolute maximum ratings (Ta = 25°C)

| Parameter | Symbol | Limit | Unit |
|---------------------------------|--------|--------------------------|------|
| Vcc applied voltage | Vcc | -15 to +50 ^{*1} | V |
| Vs pin voltage (BD3004HFP) | Vs | -0.3 to +15 | V |
| INH pin voltage (BD3005HFP) | VINH | -0.3 to +15 | V |
| Regulator output pin voltage | VOUT | -0.3 to +15 | V |
| Reset output pin voltage | VRO | -0.3 to +15 | V |
| Watchdog input pin voltage | VCLK | -0.3 to +15 | V |
| Reset delay setting pin voltage | VCT | -0.3 to +15 | V |
| Output current | IOUT | 500 | mA |
| Power dissipation | Pd | 1.6 ^{*2} | W |
| Operating temperature range | Topr | -40 to +125 | °C |
| Storage temperature range | Tstg | -55 to +150 | °C |
| Maximum junction temperature | Tjmax | 150 | °C |

*1 Must not exceed Pd.

*2 Reduced by 12.8 mW/°C over 25°C, when mounted on a glass epoxy board (70 mm \times 70 mm \times 1.6 mm).

●Operating power supply voltage range (Ta = 25°C)

| Parameter | Min. | Max. | Unit |
|--------------------------------------|------|------|------|
| Operating power supply voltage range | 5.5* | 36** | V |
| Output current | — | 500 | mA |

* For the output voltage, consider the voltage drop (min. I/O voltage differential) due to the output current.

** Must not exceed Pd.

●Electrical Characteristics (Unless otherwise specified, Ta = -40°C to 125°C, Vcc = 13.5 V)

| Parameter | Symbol | Limit | | | Unit | Conditions |
|---------------------------------------|----------|-------|------|------|------|------------------------------|
| | | Min. | Typ. | Max. | | |
| [Overall] | | | | | | |
| Total supply current 1 | Icc1 | — | 80 | 130 | μA | Io=0mA |
| Total supply current 2 | Icc2 | — | 80 | 130 | μA | Io=200mA |
| Total supply current 3(BD3005HFP) | Icc3 | — | 80 | 130 | μA | VINH=0V |
| [Regulator] | | | | | | |
| Output voltage | VOUT | 4.90 | 5.00 | 5.10 | V | |
| Input stability | Line.Reg | — | 10 | 20 | mV | Vcc=6.2~25 V |
| Load stability | Load.Reg | — | 15 | 30 | mV | Io=5~200mA |
| Min. I/O voltage differential | ΔVd | — | 0.78 | 1.1 | V | Vcc=4.75 V, Io=200mA |
| Output current | IOUT | 500 | — | — | mA | VOUT=4.9V |
| Ripple rejection | R.R. | 45 | 55 | — | dB | f=120Hz, ein=1Vrms, Io=200mA |
| [Reset] | | | | | | |
| Detection voltage(BD3004HFP) | Vdet | 4.02 | 4.10 | 4.18 | V | |
| Detection voltage(BD3005HFP) | Vdet | 4.40 | 4.50 | 4.60 | V | |
| Hysteresis width | VHS | 50 | 100 | 150 | mV | |
| Output delay time Low → High | TdLH | 12 | 21 | 40 | mS | CT=0.1μF ¹ |
| Low output voltage | VRST | — | 0.2 | 0.5 | V | IRST=2mA |
| Min. operating voltage | VOPL | 1.0 | — | — | V | |
| [Watchdog timer] | | | | | | |
| High-side switching threshold voltage | VthH | 1.16 | 1.26 | 1.36 | V | |
| Low-side switching threshold voltage | VthL | 0.20 | 0.24 | 0.28 | V | |
| Discharge current | Ictc | 1 | 2 | 3 | μA | |
| Charge current | Icto | 3 | 6 | 10 | μA | |
| Watchdog monitor time | TWH | 32 | 51 | 90 | mS | CT=0.1μF ² |
| Watchdog reset time | TWL | 10 | 17 | 30 | mS | CT=0.1μF ³ |
| Clock input pulse width | TWCLK | 500 | — | — | nS | |
| [INH] | | | | | | |
| WDT off voltage(BD3005HFP) | VUINH | 3.2 | — | 8.0 | V | |
| WDT on voltage(BD3005HFP) | VLINH | 0 | — | 1.8 | V | |

*1 TdLH can be varied by changing the CT capacitance value.

$$T_{dLH} (s) \approx (1.26 \times CT (\mu F)) / I_{cto} (\mu A) \text{ (Calculation uses Typ. values)}$$

*2 TWH can be varied by changing the CT capacitance value.

$$T_{WH} (s) \approx (1.02 \times CT (\mu F)) / I_{ctc} (\mu A) \text{ (Calculation uses Typ. values)}$$

*3 TWL can be varied by changing the CT capacitance value.

$$T_{WL} (s) \approx (1.02 \times CT (\mu F)) / I_{cto} (\mu A) \text{ (Calculation uses Typ. values)}$$

Note: This IC is not designed to be radiation-resistant.

●Reference data (Unless otherwise specified, Ta = 25°C)

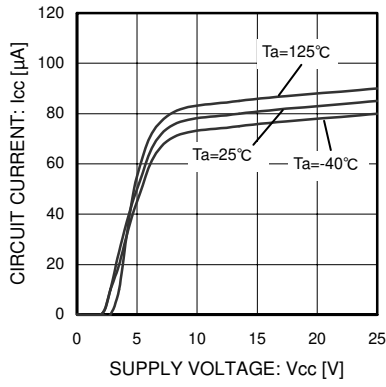

Fig. 1 Circuit Current

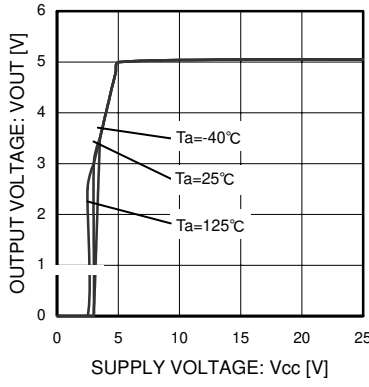

Fig. 2 Output Voltage vs Supply Voltage

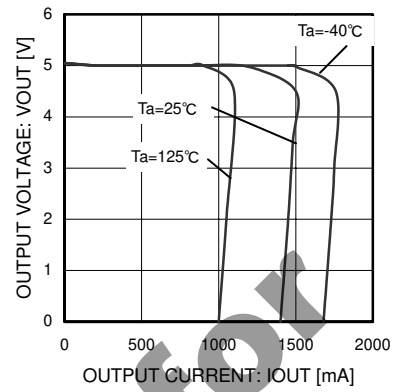

Fig. 3 Output Voltage vs Load

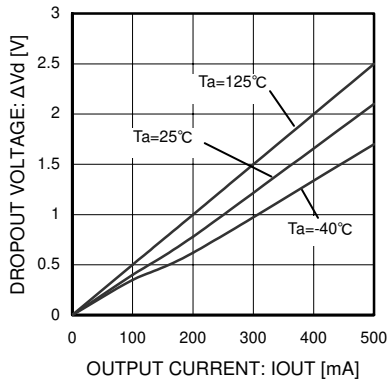

Fig. 4 I/O Voltage Difference

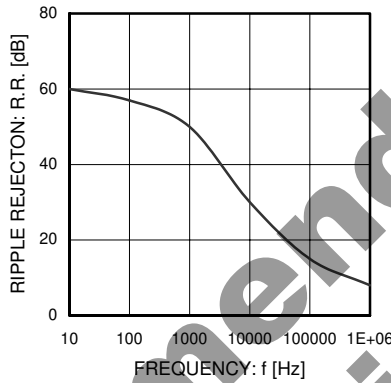

Fig. 5 Ripple Rejection

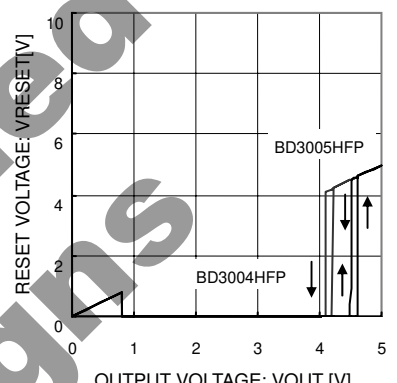

Fig. 6 Reset Detection Voltage

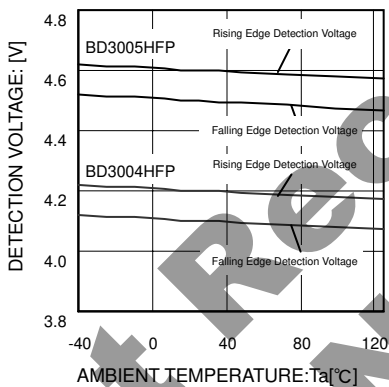

Fig. 7 Reset Detection Voltage Temperature

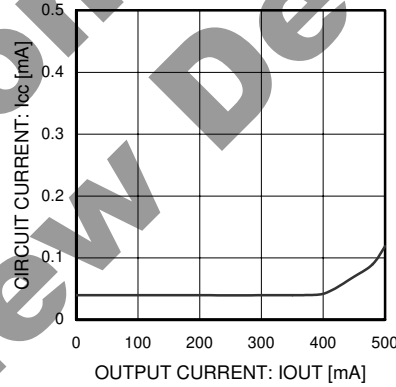

Fig. 8 Total Supply Current Classified by Load

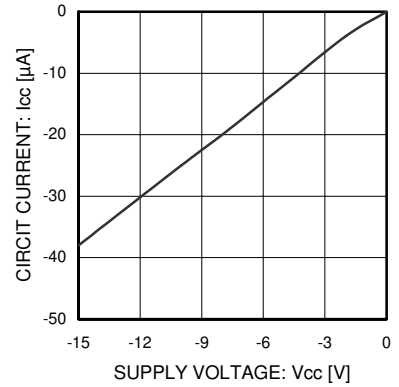

Fig. 9 Back Current

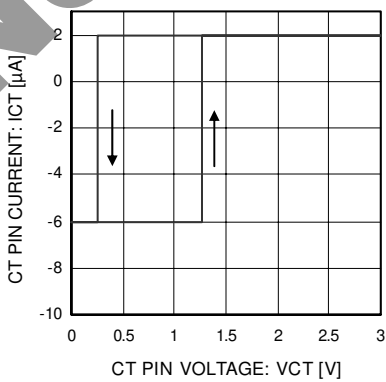

Fig. 10 CT Pin Charge vs Discharge Current

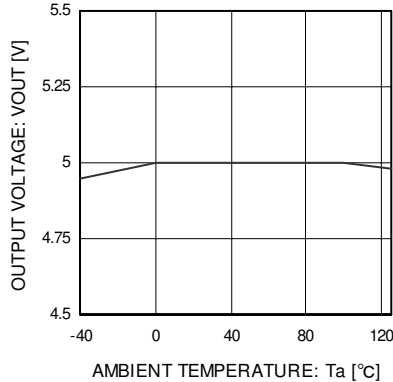

Fig. 11 Output Voltage vs Temperature

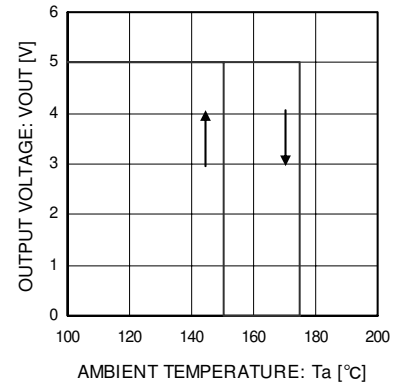
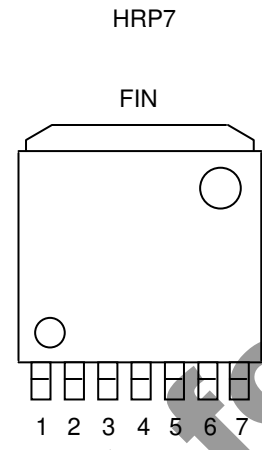
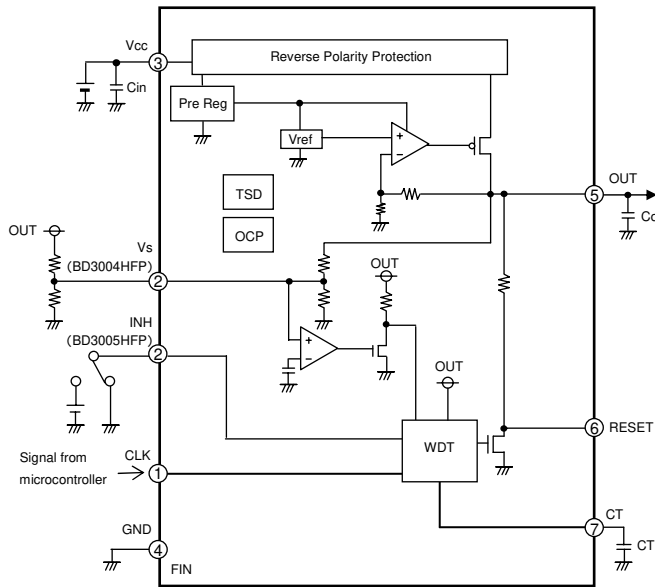

Fig. 12 Thermal Shutdown Circuit

●Block diagram



Cin: 0.33 μ F to 1000 μ F
 Co: 0.1 μ F to 1000 μ F
 CT: 0.001 μ F to 22 μ F

Fig.13

●Pin descriptions

| Pin. No | Pin name | Function |
|---------|----------------|---|
| 1 | CLK | Clock input from microcontroller |
| 2 | Vs(BD3004HFP) | Reset detection voltage adjustment function pin |
| | INH(BD3005HFP) | WDT on/off function pin (WDT off when INH = high; WDT on when INH = low) |
| 3 | Vcc | Power supply pin |
| 4 | GND | GND pin |
| 5 | OUT | Voltage output pin |
| 6 | RESET | Reset output pin |
| 7 | CT | Reset output delay time, WDT monitor time setting external capacitance connection pin |
| FIN | GND | GND pin |

●I/O Circuit diagram

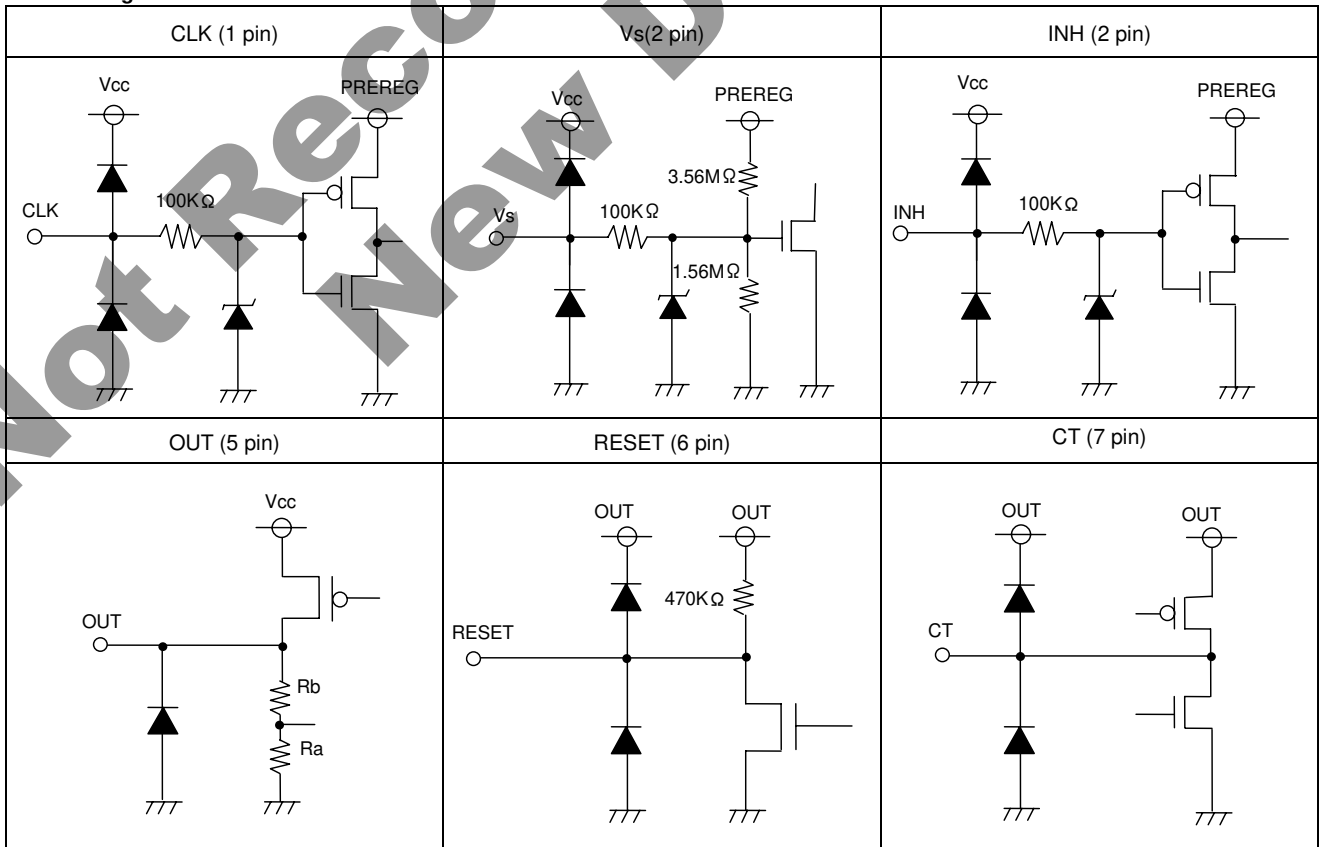
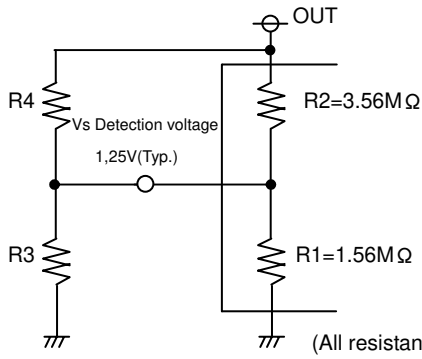

Fig.14

* All resistance values are typical ones.

● Detection voltage adjustment



For a basic detection voltage of 4.1 V,
 $V_{det} = V_s \times (R_1 + R_2 / R_1)$

To change the detection voltage,
 insert pull-down resistor R3 (with a resistance value lower than R1)
 between the Vs and GND pins, and pull-up resistor R4 (with a
 resistance value lower than R2) between the Vs and Vo pins.

$$V_{det} = V_s \times (R_3 + R_4 / R_3) \quad [R_3 \ll R_1, R_4 \ll R_2]$$

(All resistance values are typical ones.)

Fig.15

● Timing chart

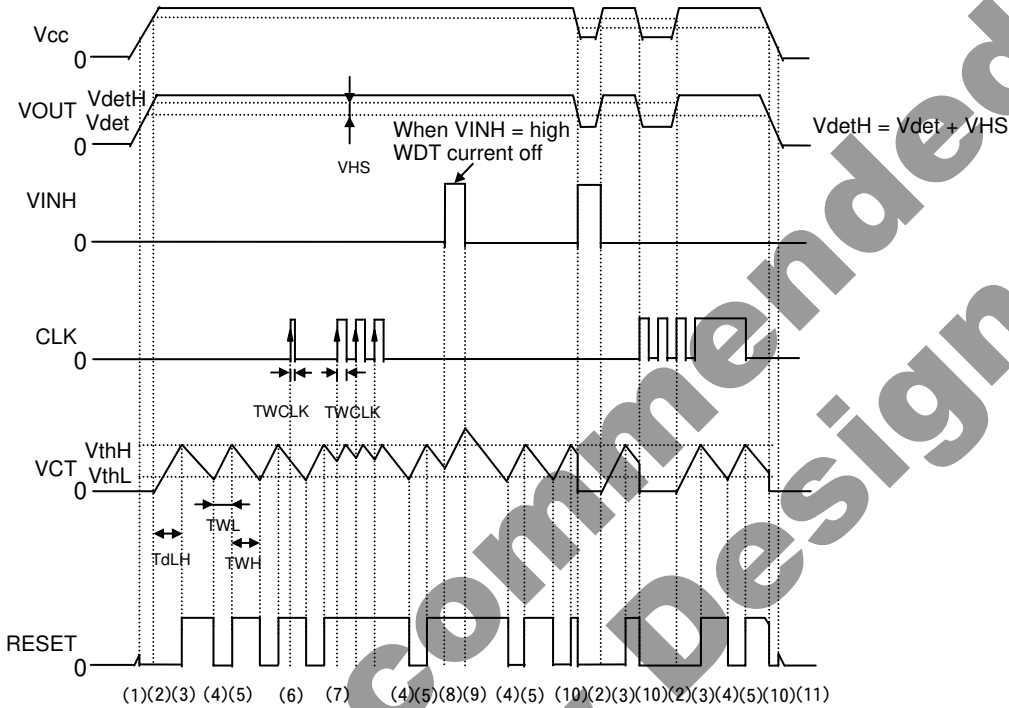

Fig.16

● Explanation

- (1) When the output voltage (VOUT) reaches 1.0 V, the reset pin voltage (RESET) will switch to low level.
- (2) When VOUT reaches or exceeds the reset clear voltage (VdetH), the external capacitor connected to the CT pin will begin to charge. When the CT pin voltage (VCT) reaches the upper switching threshold voltage (VthH), RESET will maintain a low-level signal. When VCT reaches the VthH voltage, RESET will switch from low to high level. The time from VCT reaching or exceeding the VdetH voltage until RESET reverses (the RESET transmission delay time: TdLH) is given by the following equation:
 $T_{dLH}(s) \approx (1.26 \times CT (\mu F)) / I_{cto} (\mu A) \dots [1]$
- (3) The watchdog timer operates when RESET rises.
- (4) When VCT reaches the lower switching threshold voltage (VthL), the CT pin switches from discharging to charging, and RESET switches from high level to low level. The watchdog timer reset time TWL is given by the following equation:
 $T_{WL}(s) \approx (1.02 \times CT (\mu F)) / I_{cto} (\mu A) \dots [2]$
- (5) The CT pin state switches from charge to discharge when VCT reaches VthH, and RESET switches from low to high. The watchdog timer monitor time TWH is given by the following equation:
 $T_{WH}(s) \approx (1.02 \times CT (\mu F)) / I_{ctc} (\mu A) \dots [3]$
- (6) The CT pin state may not switch from charge to discharge when the CLK input pulse width (TWCLK) is short. Use a TWCLK input pulse width of at least 500 ns.
- (7) When a pulse (positive edge trigger) of at least 500 ns is input to the CLK pin while the CT pin is discharging, VCT switches from discharging to charging and then switches back to discharging once it charges to VthH.
- (8) Watchdog timer operation is forced off when the INH pin switches to high. At that time, only the watchdog timer will be turned off, and reset detection will operate normally.
- (9) The watchdog timer function turns on when the INH pin switches to low. At that time, the external capacitor on the CT pin will be discharged.
- (10) RESET switches from high to low when OUT falls to the RESET detection voltage (VDET) or lower.
- (11) When VOUT falls to 0 V, the RESET signal stays low until VOUT reaches 1.0 V

●Setting of heat

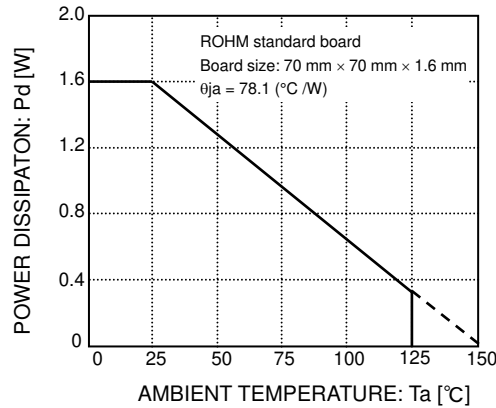

Fig.17

Refer to the dissipation reduction illustrated in Fig.17 when using the IC in an environment where $T_a \geq 25^\circ\text{C}$. The characteristics of the IC are greatly influenced by the operating temperature. If the temperature exceeds the maximum junction temperature T_{jmax} , the elements of the IC may be damaged. It is necessary to give sufficient consideration to the heat of the IC in view of two points, i.e., the protection of the IC from instantaneous damage and the maintenance of the reliability of the IC in long-time operation.

In order to protect the IC from thermal destruction, the operating temperature of the IC must not exceed the maximum junction temperature T_{jmax} . Fig.17 illustrates the power dissipation/heat mitigation characteristics for the HRP-7 package. Always operate the IC within the power dissipation (P_d). The following method is used to calculate the power consumption P_c (W).

$$P_c = (V_{cc} - V_{OUT}) \times I_{OUT} + V_{cc} \times I_{cc}$$

$$\text{Power dissipation } P_d \leq P_c$$

- V_{cc} : Input voltage
- V_{OUT} : Output voltage
- I_{OUT} : Load current
- I_{cc} : Total supply current

The load current I_o is obtained to operate the IC within the power dissipation.

$$I_{OUT} \leq \frac{P_d - V_{cc} \times I_{cc}}{V_{cc} - V_{OUT}} \quad \text{For } I_{cc}, \text{ see Fig. 1.}$$

From the above, the maximum load current I_{OUTmax} for the applied voltage V_{cc} can be calculated during the thermal design process.

Calculation example

Example: at $T_a = 85^\circ\text{C}$, $V_{cc} = 12\text{ V}$, $V_{OUT} = 5\text{ V}$

$$I_{OUT} \leq \frac{0.832 - 12 \times I_{cc}}{12 - 5}$$

$$I_{OUT} \leq 118\text{ mA} \quad (I_{cc} = 80\text{ }\mu\text{A})$$

$\theta_{ja} = 78.1^\circ\text{C/W} \rightarrow -12.8\text{ mW}/^\circ\text{C}$
 $25^\circ\text{C} = 1.6\text{ W} \rightarrow 85^\circ\text{C} = 0.832\text{ mW}$

Make a thermal calculation in consideration of the above equations so that the whole operating temperature range will be within the power dissipation. The power consumption P_c of the IC, in the event of shorting (i.e., if the V_o and GND pins are shorted), will be obtained from the following equation:

$$P_c = V_{cc} \times (I_{cc} + I_{short}) \quad I_{short} = \text{Short current}$$

●External settings for pins and precautions

1) V_{cc} pin

Insert capacitors with a capacitance of $0.33\text{ }\mu\text{F}$ to $1,000\text{ }\mu\text{F}$ between the V_{cc} and GND pins. The capacitance varies with the application. Be sure to design the capacitance with a sufficient margin.

2) Output pin

Capacitors for stopping oscillation must be placed between each output pin and the GND pin. Capacitor capacitance values can be used in a range between $0.1\text{ }\mu\text{F}$ and $1,000\text{ }\mu\text{F}$. Since oscillation does not occur even for ESR values from $0.001\text{ }\Omega$ to $100\text{ }\Omega$, a ceramic capacitor can be used. Abrupt input voltage and load fluctuations can affect output voltages. Output capacitor capacitance values should be determined after sufficient testing of the actual application

3) CT pin

Be sure to connect a capacitor to the CT pin. The reset output delay time is given by equation (1) on P. 5. The WDT time is given by equations (2) and (3) on P.5. The setting times are proportional to the capacitance value of CT pin from the equations, so the maximum and minimum setting times can be calculated from the electrical characteristics according to the capacitance. Note however that the electrical characteristics do not include the external capacitor's temperature characteristics. The recommended connection capacity for the CT pin is $0.001\text{ }\mu\text{F}$ to $22\text{ }\mu\text{F}$.

● Operation Notes

- Absolute maximum ratings**
An excess in the absolute maximum ratings, such as supply voltage, temperature range of operating conditions, etc., can break down the devices, thus making impossible to identify breaking mode, such as a short circuit or an open circuit. If any over rated values will expect to exceed the absolute maximum ratings, consider adding circuit protection devices, such as fuses.
- GND voltage**
The potential of GND pin must be minimum potential in all operating conditions.
- Thermal design**
Use a thermal design that allows for a sufficient margin in light of the power dissipation (Pd) in actual operating conditions.
- Inter-pin shorts and mounting errors**
Use caution when positioning the IC for mounting on printed circuit boards. The IC may be damaged if there is any connection error or if pins are shorted together.
- Actions in strong electromagnetic field**
Use caution when using the IC in the presence of a strong electromagnetic field as doing so may cause the IC to malfunction.
- Testing on application boards**
When testing the IC on an application board, connecting a capacitor to a pin with low impedance subjects the IC to stress. Always discharge capacitors after each process or step. Always turn the IC's power supply off before connecting it to or removing it from a jig or fixture during the inspection process. Ground the IC during assembly steps as an antistatic measure. Use similar precaution when transporting or storing the IC.

7. Regarding input pin of the IC

This monolithic IC contains P+ isolation and P substrate layers between adjacent elements in order to keep them isolated. P-N junctions are formed at the intersection of these P layers with the N layers of other elements, creating a parasitic diode or transistor. For example, the relation between each potential is as follows:

When $GND > Pin A$ and $GND > Pin B$, the P-N junction operates as a parasitic diode.

When $GND > Pin B$, the P-N junction operates as a parasitic transistor.

Parasitic diodes can occur inevitable in the structure of the IC. The operation of parasitic diodes can result in mutual interference among circuits, operational faults, or physical damage. Accordingly, methods by which parasitic diodes operate, such as applying a voltage that is lower than the GND (P substrate) voltage to an input pin, should not be used.

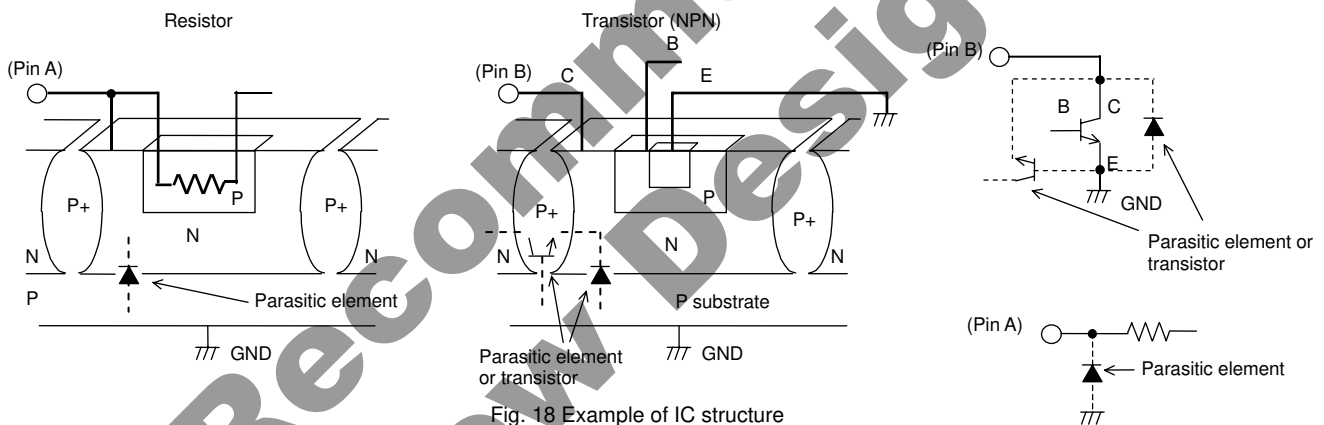
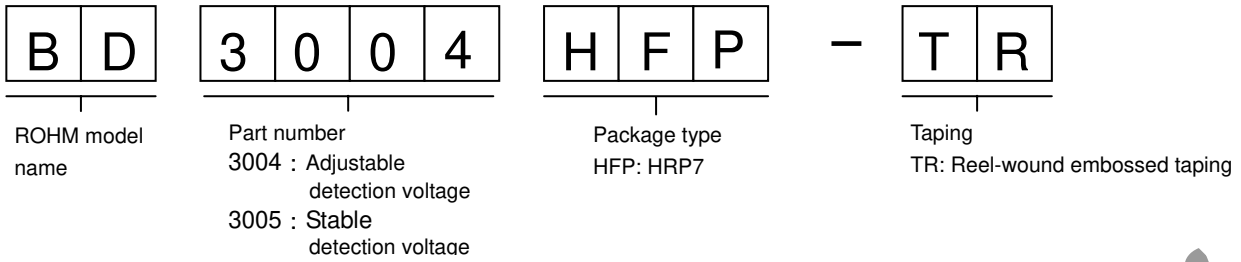

Fig. 18 Example of IC structure

- Ground Wiring Pattern**
When using both small signal and large current GND patterns, it is recommended to isolate the two ground patterns, placing a single ground point at the ground potential of application so that the pattern wiring resistance and voltage variations caused by large currents do not cause variations in the small signal ground voltage. Be careful not to change the GND wiring pattern of any external components, either.
- Thermal shutdown circuit (TSD)**
The IC incorporates a built-in thermal shutdown circuit (TSD circuit). The thermal shutdown circuit (TSD circuit) is designed only to shut the IC off to prevent runaway thermal operation. It is not designed to protect the IC or guarantee its operation. Do not continue to use the IC after operating this circuit or use the IC in an environment where the operation of this circuit is assumed.. (See Fig. 12)
- Overcurrent protection circuit (OCP)**
The IC incorporates a built-in overcurrent protection circuit that operates according to the output current capacity. This circuit serves to protect the IC from damage when the load is shorted. The protection circuit is designed to limit current flow by not latching in the event of a large and instantaneous current flow originating from a large capacitor or other component. These protection circuits are effective in preventing damage due to sudden and unexpected accidents. However, the IC should not be used in applications characterized by the continuous operation or transitioning of the protection circuits. At the time of thermal designing, keep in mind that the current capability has negative characteristics to temperatures. (See Fig. 3)
- Negative surge application to Vcc pin**
The IC incorporates a built-in reverse connection breakdown prevention circuit that prevents IC damage even if Vcc carries a lower voltage than the GND pin. However, note that the absolute maximum rating for the negative power supply voltage is -15 V.
- Back current flow when the Vcc power supply is suddenly interrupted**
These ICs limit generation of back current flow when the Vcc power supply is suddenly interrupted to protect the IC from damage. Sinking current is also limited, making the series compatible with designs where high-capacitance capacitors are used to lengthen the amount of time over which the output voltage can be maintained.

●Selecting a model name when ordering



HRP7

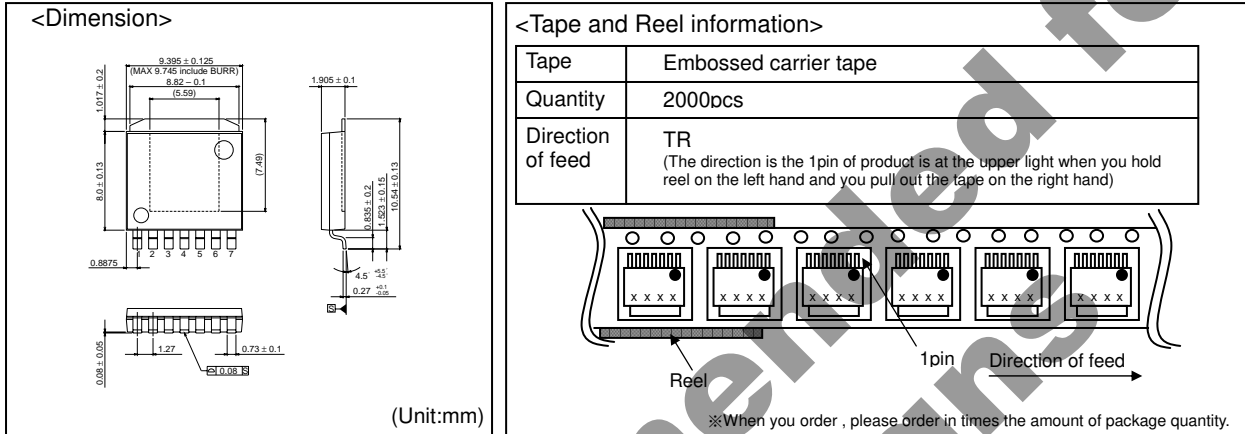

- The contents described herein are correct as of July, 2006
- The contents described herein are subject to change without notice. For updates of the latest information, please contact and confirm with ROHM CO.,LTD.
- Any part of this application note must not be duplicated or copied without our permission.
- Application circuit diagrams and circuit constants contained herein are shown as examples of standard use and operation. Please pay careful attention to the peripheral conditions when designing circuits and deciding upon circuit constants in the set.
- Any data, including, but not limited to application circuit diagrams and information, described herein are intended only as illustrations of such devices and not as the specifications for such devices. ROHM CO.,LTD. disclaims any warranty that any use of such devices shall be free from infringement of any third party's intellectual property rights or other proprietary rights, and further, assumes no liability of whatsoever nature in the event of any such infringement, or arising from or connected with or related to the use of such devices.
- Upon the sale of any such devices, other than for buyer's right to use such devices itself, resell or otherwise dispose of the same, implied right or license to practice or commercially exploit any intellectual property rights or other proprietary rights owned or controlled by ROHM CO., LTD. is granted to any such buyer.
- The products described herein utilize silicon as the main material.
- The products described herein are not designed to be X ray proof.

The products listed in this catalog are designed to be used with ordinary electronic equipment or devices (such as audio visual equipment, office-automation equipment, communications devices, electrical appliances and electronic toys). Should you intend to use these products with equipment or devices which require an extremely high level of reliability and the malfunction of which would directly endanger human life (such as medical instruments, transportation equipment, aerospace machinery, nuclear-reactor controllers, fuel controllers and other safety devices), please be sure to consult with our sales representative in advance.

Contact us for further information about the products.

Excellence in Electronics



ROHM CO., LTD.

21, Saiin Mizosaki-cho, Ukyo-ku, Kyoto
615-8585, Japan
TEL: +81-75-311-2121 FAX: +81-75-315-0172
URL: http://www.rohm.com

Published by
LSI Application Engineering Dept.

- | | |
|---|---|
| Seoul TEL: +82-2-8182-700 FAX: +82-2-8182-715 | Bangkok TEL: +66-2-254-4890 FAX: +66-2-256-6334 |
| Masan TEL: +82-55-240-6234 FAX: +82-55-240-6236 | Kuala Lumpur TEL: +60-3-7958-8355 FAX: +60-3-7958-8377 |
| Dalian TEL: +86-411-8230-8549 FAX: +86-411-8230-8537 | Penang TEL: +60-4-6585084 FAX: +60-4-6585167 |
| Beijing TEL: +86-10-8525-2483 FAX: +86-10-8525-2489 | Dusseldorf TEL: +49-2145-9210 FAX: +49-2154-921400 |
| Tianjin TEL: +86-22-23029181 FAX: +86-22-23029183 | Munich TEL: +49-8161-48310 FAX: +49-8161-483120 |
| Shanghai TEL: +86-21-6279-2727 FAX: +86-21-6247-2066 | Stuttgart TEL: +49-711-72723710 FAX: +49-711-72723720 |
| Hangzhou TEL: +86-571-87658072 FAX: +86-571-87658071 | France TEL: +33-1-5697-3060 FAX: +33-1-5697-3080 |
| Nanjing TEL: +86-25-8689-0015 FAX: +86-25-8689-0393 | United Kingdom TEL: +44-1-908-306700 FAX: +44-1-908-235788 |
| Ningbo TEL: +86-574-87654201 FAX: +86-574-87654208 | Denmark TEL: +45-3694-4739 FAX: +45-3694-4789 |
| Qingdao TEL: +86-532-5779-312 FAX: +86-532-5779-653 | Barcelona TEL: +34-9375-24320 FAX: +34-9375-24410 |
| Suzhou TEL: +86-512-6807-1300 FAX: +86-512-6807-2300 | Malaga TEL: +34-9520-20263 FAX: +34-9520-20023 |
| Tianjin TEL: +86-22-23029181 FAX: +86-22-23029183 | Hungary TEL: +36-1-4719338 FAX: +36-1-4719339 |
| Wuxi TEL: +86-510-82702693 FAX: +86-510-82702992 | Poland TEL: +48-22-5757213 FAX: +48-22-5757001 |
| Hong Kong TEL: +852-2-740-6262 FAX: +852-2-375-8971 | Russia TEL: +7-95-980-6755 FAX: +7-95-937-8290 |
| Dongguan TEL: +86-769-393-3320 FAX: +86-769-398-4140 | San Diego TEL: +1-858-625-3630 FAX: +1-858-625-3670 |
| Fuzhou TEL: +86-591-8801-8698 FAX: +86-591-8801-8690 | Atlanta TEL: +1-770-754-5972 FAX: +1-770-754-0691 |
| Guangzhou TEL: +86-20-8364-9796 FAX: +86-20-8364-9707 | Boston TEL: +1-978-371-0382 FAX: +1-928-438-7164 |
| Shenzhen TEL: +86-755-8307-3001 FAX: +86-755-8307-3003 | Chicago TEL: +1-847-368-1006 FAX: +1-847-368-1008 |
| Xiamen TEL: +86-592-239-8382 FAX: +86-592-239-8380 | Dallas TEL: +1-972-312-8818 FAX: +1-972-312-0330 |
| Zhuhai TEL: +86-756-3232-480 FAX: +86-756-3232-460 | Denver TEL: +1-303-708-0908 FAX: +1-303-708-0858 |
| Taipei TEL: +886-7-237-0881 FAX: +886-7-238-7332 | Nashville TEL: +1-615-620-6700 FAX: +1-615-620-6702 |
| Kaohsiung TEL: +86-6-332-2322 FAX: +86-6-332-2322 | Guadalajara TEL: +52-33-3123-2001 FAX: +52-33-3123-2002 |
| Singapore TEL: +65-632-8077 FAX: +65-632-8077 | |
| Manila TEL: +63-2-807-6872 FAX: +63-2-809-1422 | |

Notice

Precaution on using ROHM Products

- Our Products are designed and manufactured for application in ordinary electronic equipments (such as AV equipment, OA equipment, telecommunication equipment, home electronic appliances, amusement equipment, etc.). If you intend to use our Products in devices requiring extremely high reliability (such as medical equipment ^(Note 1), transport equipment, traffic equipment, aircraft/spacecraft, nuclear power controllers, fuel controllers, car equipment including car accessories, safety devices, etc.) and whose malfunction or failure may cause loss of human life, bodily injury or serious damage to property ("Specific Applications"), please consult with the ROHM sales representative in advance. Unless otherwise agreed in writing by ROHM in advance, ROHM shall not be in any way responsible or liable for any damages, expenses or losses incurred by you or third parties arising from the use of any ROHM's Products for Specific Applications.

(Note1) Medical Equipment Classification of the Specific Applications

| JAPAN | USA | EU | CHINA |
|-----------|-----------|------------|-----------|
| CLASS III | CLASS III | CLASS II b | CLASS III |
| CLASS IV | | CLASS III | |

- ROHM designs and manufactures its Products subject to strict quality control system. However, semiconductor products can fail or malfunction at a certain rate. Please be sure to implement, at your own responsibilities, adequate safety measures including but not limited to fail-safe design against the physical injury, damage to any property, which a failure or malfunction of our Products may cause. The following are examples of safety measures:
 - Installation of protection circuits or other protective devices to improve system safety
 - Installation of redundant circuits to reduce the impact of single or multiple circuit failure
- Our Products are designed and manufactured for use under standard conditions and not under any special or extraordinary environments or conditions, as exemplified below. Accordingly, ROHM shall not be in any way responsible or liable for any damages, expenses or losses arising from the use of any ROHM's Products under any special or extraordinary environments or conditions. If you intend to use our Products under any special or extraordinary environments or conditions (as exemplified below), your independent verification and confirmation of product performance, reliability, etc. prior to use, must be necessary:
 - Use of our Products in any types of liquid, including water, oils, chemicals, and organic solvents
 - Use of our Products outdoors or in places where the Products are exposed to direct sunlight or dust
 - Use of our Products in places where the Products are exposed to sea wind or corrosive gases, including Cl₂, H₂S, NH₃, SO₂, and NO₂
 - Use of our Products in places where the Products are exposed to static electricity or electromagnetic waves
 - Use of our Products in proximity to heat-producing components, plastic cords, or other flammable items
 - Sealing or coating our Products with resin or other coating materials
 - Use of our Products without cleaning residue of flux (even if you use no-clean type fluxes, cleaning residue of flux is recommended); or Washing our Products by using water or water-soluble cleaning agents for cleaning residue after soldering
 - Use of the Products in places subject to dew condensation
- The Products are not subject to radiation-proof design.
- Please verify and confirm characteristics of the final or mounted products in using the Products.
- In particular, if a transient load (a large amount of load applied in a short period of time, such as pulse. is applied, confirmation of performance characteristics after on-board mounting is strongly recommended. Avoid applying power exceeding normal rated power; exceeding the power rating under steady-state loading condition may negatively affect product performance and reliability.
- De-rate Power Dissipation (Pd) depending on Ambient temperature (Ta). When used in sealed area, confirm the actual ambient temperature.
- Confirm that operation temperature is within the specified range described in the product specification.
- ROHM shall not be in any way responsible or liable for failure induced under deviant condition from what is defined in this document.

Precaution for Mounting / Circuit board design

- When a highly active halogenous (chlorine, bromine, etc.) flux is used, the residue of flux may negatively affect product performance and reliability.
- In principle, the reflow soldering method must be used; if flow soldering method is preferred, please consult with the ROHM representative in advance.

For details, please refer to ROHM Mounting specification

Precautions Regarding Application Examples and External Circuits

1. If change is made to the constant of an external circuit, please allow a sufficient margin considering variations of the characteristics of the Products and external components, including transient characteristics, as well as static characteristics.
2. You agree that application notes, reference designs, and associated data and information contained in this document are presented only as guidance for Products use. Therefore, in case you use such information, you are solely responsible for it and you must exercise your own independent verification and judgment in the use of such information contained in this document. ROHM shall not be in any way responsible or liable for any damages, expenses or losses incurred by you or third parties arising from the use of such information.

Precaution for Electrostatic

This Product is electrostatic sensitive product, which may be damaged due to electrostatic discharge. Please take proper caution in your manufacturing process and storage so that voltage exceeding the Products maximum rating will not be applied to Products. Please take special care under dry condition (e.g. Grounding of human body / equipment / solder iron, isolation from charged objects, setting of ionizer, friction prevention and temperature / humidity control).

Precaution for Storage / Transportation

1. Product performance and soldered connections may deteriorate if the Products are stored in the places where:
 - [a] the Products are exposed to sea winds or corrosive gases, including Cl₂, H₂S, NH₃, SO₂, and NO₂
 - [b] the temperature or humidity exceeds those recommended by ROHM
 - [c] the Products are exposed to direct sunshine or condensation
 - [d] the Products are exposed to high Electrostatic
2. Even under ROHM recommended storage condition, solderability of products out of recommended storage time period may be degraded. It is strongly recommended to confirm solderability before using Products of which storage time is exceeding the recommended storage time period.
3. Store / transport cartons in the correct direction, which is indicated on a carton with a symbol. Otherwise bent leads may occur due to excessive stress applied when dropping of a carton.
4. Use Products within the specified time after opening a humidity barrier bag. Baking is required before using Products of which storage time is exceeding the recommended storage time period.

Precaution for Product Label

QR code printed on ROHM Products label is for ROHM's internal use only.

Precaution for Disposition

When disposing Products please dispose them properly using an authorized industry waste company.

Precaution for Foreign Exchange and Foreign Trade act

Since our Products might fall under controlled goods prescribed by the applicable foreign exchange and foreign trade act, please consult with ROHM representative in case of export.

Precaution Regarding Intellectual Property Rights

1. All information and data including but not limited to application example contained in this document is for reference only. ROHM does not warrant that foregoing information or data will not infringe any intellectual property rights or any other rights of any third party regarding such information or data. ROHM shall not be in any way responsible or liable for infringement of any intellectual property rights or other damages arising from use of such information or data.:
2. No license, expressly or implied, is granted hereby under any intellectual property rights or other rights of ROHM or any third parties with respect to the information contained in this document.

Other Precaution

1. This document may not be reprinted or reproduced, in whole or in part, without prior written consent of ROHM.
2. The Products may not be disassembled, converted, modified, reproduced or otherwise changed without prior written consent of ROHM.
3. In no event shall you use in any way whatsoever the Products and the related technical information contained in the Products or this document for any military purposes, including but not limited to, the development of mass-destruction weapons.
4. The proper names of companies or products described in this document are trademarks or registered trademarks of ROHM, its affiliated companies or third parties.

General Precaution

1. Before you use our Products, you are requested to carefully read this document and fully understand its contents. ROHM shall not be in any way responsible or liable for failure, malfunction or accident arising from the use of any ROHM's Products against warning, caution or note contained in this document.
2. All information contained in this document is current as of the issuing date and subject to change without any prior notice. Before purchasing or using ROHM's Products, please confirm the latest information with a ROHM sales representative.
3. The information contained in this document is provided on an "as is" basis and ROHM does not warrant that all information contained in this document is accurate and/or error-free. ROHM shall not be in any way responsible or liable for any damages, expenses or losses incurred by you or third parties resulting from inaccuracy or errors of or concerning such information.

**Not Recommended for
New Designs**



BD3004HFP - Web Page

| | |
|-----------------------------|-----------|
| Part Number | BD3004HFP |
| Package | HRP7 |
| Unit Quantity | 2000 |
| Minimum Package Quantity | 2000 |
| Packing Type | Taping |
| Constitution Materials List | inquiry |
| RoHS | Yes |