

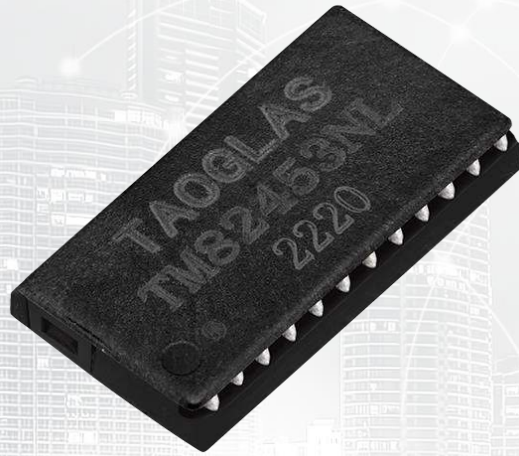

# TAOGLAS®



# Datasheet

## LAN Transformer 1G Base-T PCMCIA

**Part No:**  
TM82453NL

**Description:**

1000 Base-T/1G transformer  
Single Port and 24pin SMT with low-profile PCMCIA

**Features:**

AutoMDIX  
PCMCIA  
RoHS & REACH Compliant

1.	Introduction	3
2.	Specifications	4
3.	Mechanical	5
4.	Electrical	6
5.	Packaging & Storage	7
<hr/>		
	Changelog	8

Taoglas makes no warranties based on the accuracy or completeness of the contents of this document and reserves the right to make changes to specifications and product descriptions at any time without notice. Taoglas reserves all rights to this document and the information contained herein. Reproduction, use or disclosure to third parties without express permission is strictly prohibited.



# 1. Introduction



Featuring a compatible footprint with industry LAN transformers, and designed to work in demanding industrial environmental conditions, the Taoglas TM82453NL is an LAN Transformer 1GBase-T Single Port of 24pin suitable of AutoMDIX feature.

Typical applications for this cost-effective part are:

- Industrial Automation
- Hubs
- Routers
- Switches
- Wireless Access Points

The Taoglas Magnetics Product Team have over fifteen years of LAN magnetics design and high-quality manufacturing. With an ever-expanding portfolio, we provide trusted products and services to customers within a wide range of applications such as: Networking and Interconnect Devices, Servers, Switches, Router, Communication systems and any Digital Consumer electronics.

The Taoglas Exos Series offer an extensive product line of LAN Transformers designed for commercial and industrial grade applications, supporting 10/100 Base-T (Exos100 Series), 1G Base-T (Exos1G Series) and 10G Base-T (Exos10G Series). These products include Single, Dual, and Quad configurations not only for standard applications but also for Power over Ethernet (PoE, PoE+, PoE++).

For more information on the range of products or for assistance with integration, contact your regional Taoglas customer support team

## 2. Specifications

Electrical Performance @25°C	
Inductance OCL	320µH MIN @ 100KHz 0.1V 8mA DC Bias
Turns Ratio (±3%)	TX=1CT: 1CT      RX=1CT: 1CT
Insertion Loss	-1dB MAX @ 0.3-100Mhz
Return Loss	-18dB MIN @ 0.3-30Mhz
	-15.5dB MIN @ 40Mhz
	-13.5dB MIN @ 50Mhz
	-10dB MIN @ 60-80Mhz
Cross talk	-38dB MIN @ 0.3-100Mhz
DCMR	-43dB MIN @ 30Mhz
	-37dB MIN @ 60Mhz
	-33dB MIN @ 100Mhz
Hi-Pot	1500Vrms
Operating voltage	3.3-5V Max 350mA

Environmental Specifications	
Operating Temperature	0°C TO +70°C

Compliance	
UL recognized - FILE NO. E528697	
RoHS Compliant	

Storage requirements	
Humidity	Storage Temperature
MSL - 1	-40°C TO +85°C

## 3. Mechanical

### 3.1 Mechanical Drawings

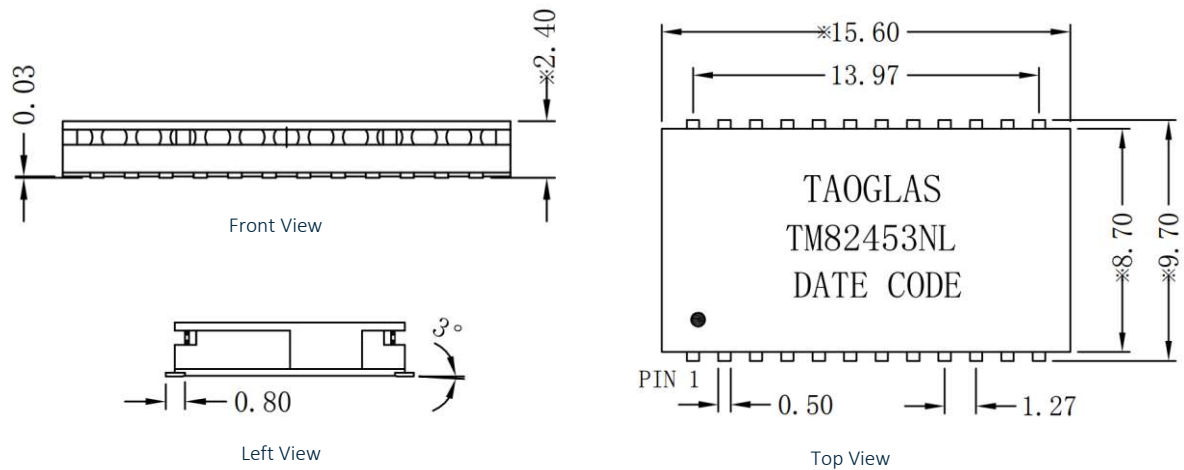

Mechanical Specifications	
Length	16.60 mm
Width	9.70 mm
Height	2.40 mm
Mounting Style	Surface Mount (SMT)

Dimensions are in millimeters with the following tolerances: X.XX =  $\pm 0.25$

### 3.2 Pad Layout

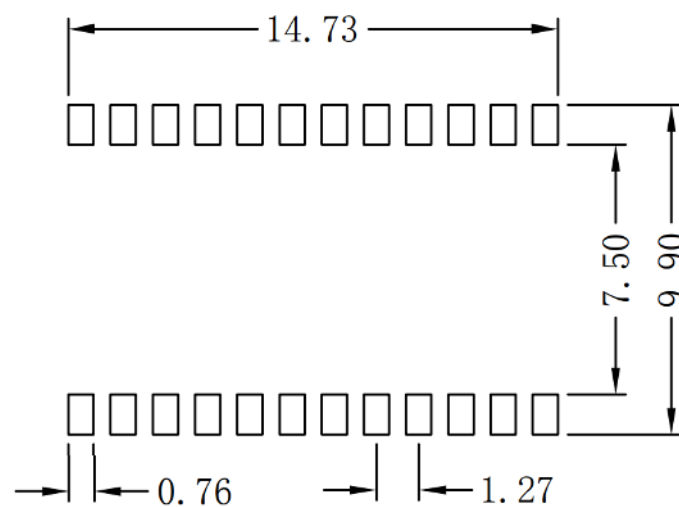

Suggested Pad Layout

Dimensions are in millimeters with the following tolerances: X.XX =  $\pm 0.10$

## 4. Electrical

### 4.1 Electrical Drawings

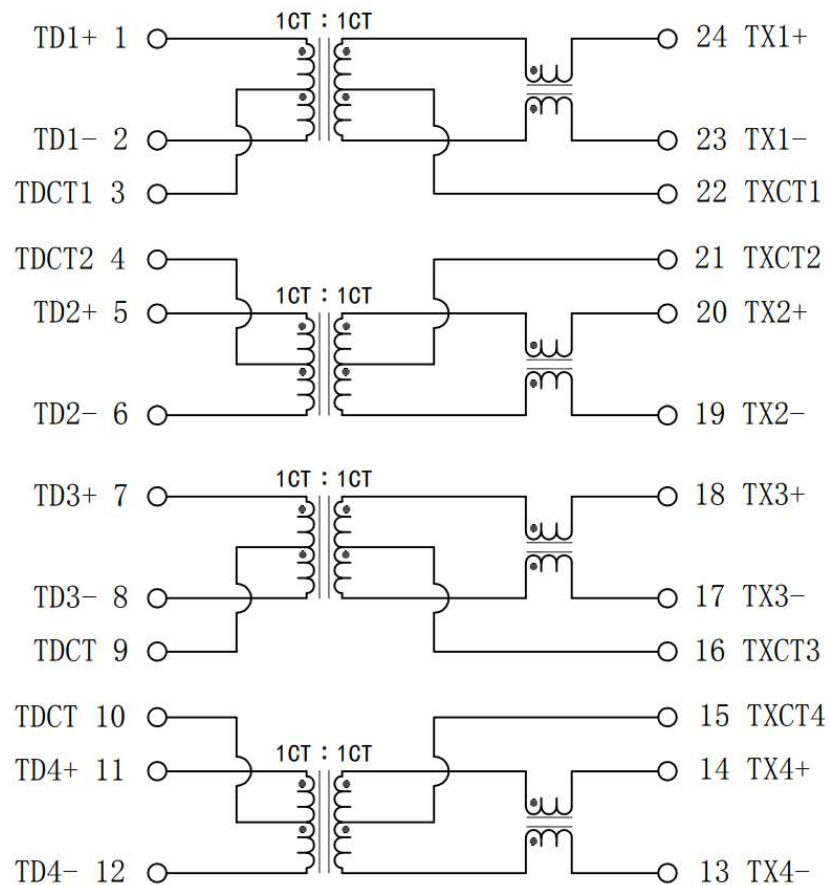

### 4.2 Profile of Reflow Solder

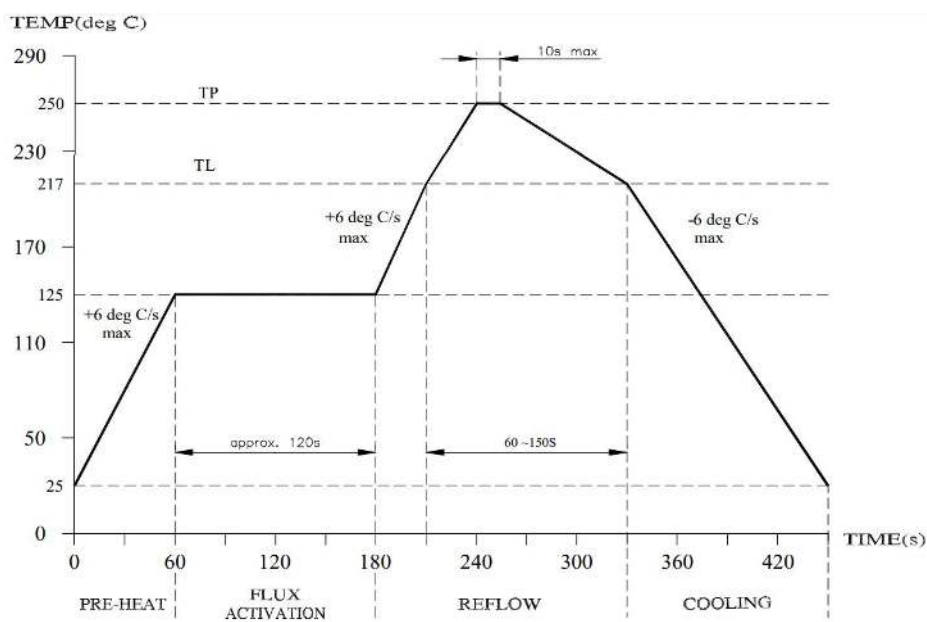

## 5. Packaging and Storage

### 5.1 SPQ

1400 pcs/reel

A (Carrier Tape Width):  $24 \pm 0.3$  mm

B (Sprocket hole to Cavity center):  $11.5 \pm 0.2$  mm

C (Cavity width):  $10.3 \pm 0.2$  mm

Reel weight: 1350g

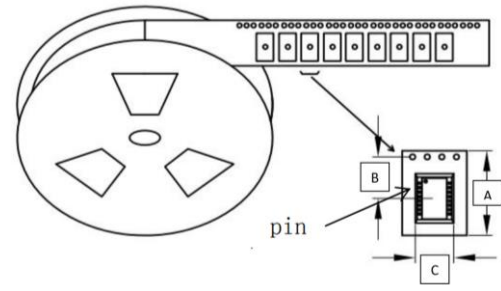

1CTN = 6 reels = 8400 pcs

Carton dimensions: 370\*370\*250mm

Carton Weight: 8kg

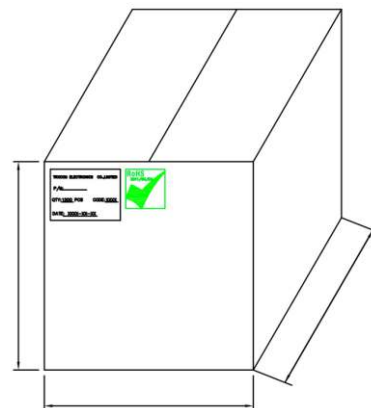

# Changelog

Changelog for the datasheet

**SPE-22-8-064 – TM82453NL**

**Revision: A (Original First Release)**

Date:	2022-11-08
Notes:	
Author:	Javier Vasena

**Previous Revisions**





[www.taoglas.com](http://www.taoglas.com)

