



NO	DESCRIPTION
1	Product Characteristics
1.1	General description
1.2	Electric Characteristics
1.3	Mechanical characteristics
2	Attachment
(Att.1)	Label
(Att.2)	Outdrawing
(Att.3)	Package
(Att.3.1)	Package flow chart
(Att.4)	Dc cord drawing

All information contained herein applies only to the above listed part number. Other versions of this part number with electrical or mechanical variations are available. Contact CUI Inc. for further assistance.

## 1. Product Characteristics:

### 1.1 General Description

Model DMS240063-P5P-SZ is a universal switching-mode power supply, operating at input voltage 90VAC to 264VAC and output voltage of 24VDC with 0.63A DC load.

### 1.2 Electric Characteristics

#### 1.2.1 Input

NO	ITEM	SPECIFICATION
1	Rated input Voltage	AC100V-240V
	Vibration input Voltage Range	AC90V-264V
2	Frequency Rated	50-60Hz
	Frequency Vibration	47-63Hz
3	Input Rated Current	600mA RMS Max
	Inrush Current	30A Max. at 115vac cool start
		60A Max. at 230vac cool start
4	Leakage current	0.25 mA
5	Efficiency	60% Min

### 1.2.2 Output:

No	ITEM	SPECIFICATION
1	*output Voltage	+24VDC
2	*output max. current	0.63A
3	output min. Current	0A
4	Line regulation	± 1%
5	Load regulation	± 5%
6	Over voltage protection	25.65V to 28.35V DC ( output shut down)
7	Short circuit protection	Output shut down and auto restart
8	Ripple Voltage (L.F.)	150mV (p-p) (100V-240VAC Input)

### 1.2.3 HI-POT SPECIFICATION

Input to output : 3000VAC or 4242VDC 10mA 1 minute.

### 1.2.4 Insulation resistance:

Input to output: 500vac to test the input to output resistance not be less  
100M ohm

### 1.2.5 Safety approved: UL,CUL,GS,CE

### 1.2.6 EMI standard : meet FCC Class B , VCCI-II , CE



### 1.3 Mechanical Characteristics:

1.3.1 AC Plug : Interchangeable PIN (US/EUROPE/UK/AUS)

1.3.2 DC cord:

1.3.2.1 Bending test: Life 1000 times 100% guarantee. Swings 120 from Left to right loading weight 500 gm , 40 cycle/minute.

1.3.2.2 Pull test : DC cord and plug ,weight 10kg for 1 minute.

1.3.3 Cord length and output plug: See Reference Att.4

1.3.4 Weight : 210 g

1.3.5 Case Size:(L) 74 × (W)43.5 × (H)34mm

1.3.6 Normal operating temperature and humidity

1.3.7 Temperature

Operating : 0°C to 40°C.

Storage : -10°C to 70°C.

1.3.8 Humidity

Operating : 20% to 80%.

Storage : 10% to 90%



## 2.Attachment

(Att.1) Label

(Att.2) Outdrawing

(Att.3) Package

(Att.3.1) Package flow chart

(Att.4) Dc Cord drawing

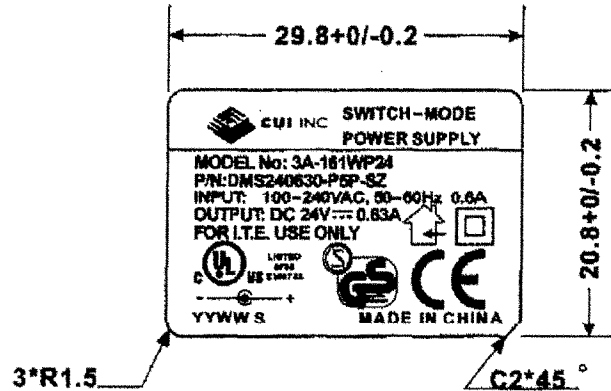

UNIT: mm

YYWW S YY:YEAR WW:WEEK S:FU YONG

ALUMINUM NAMEPLATE: ○ BLACK WORD ON SILVER BASE

○ SILVER WORD ON BLACK BASE

METALIZED POLYESTER: ● BLACK WORD ON SILVER BASE  
(SILVER MATTE)

○ SILVER WORD ON BLACK BASE

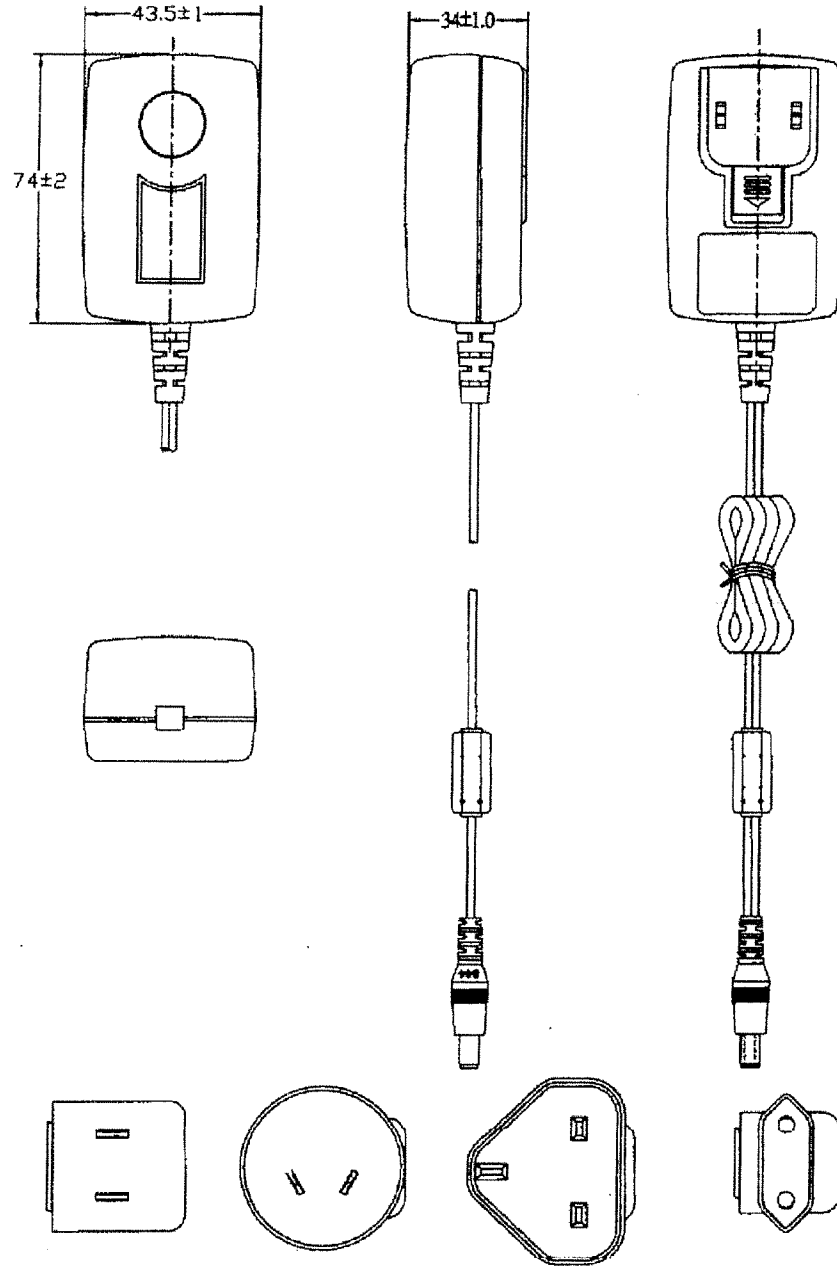



CARTON SIZE: 485X428X210mm

485X428X210mm

Q'TY: 60pcs(20x3x1)

60pcs(20x3x1)

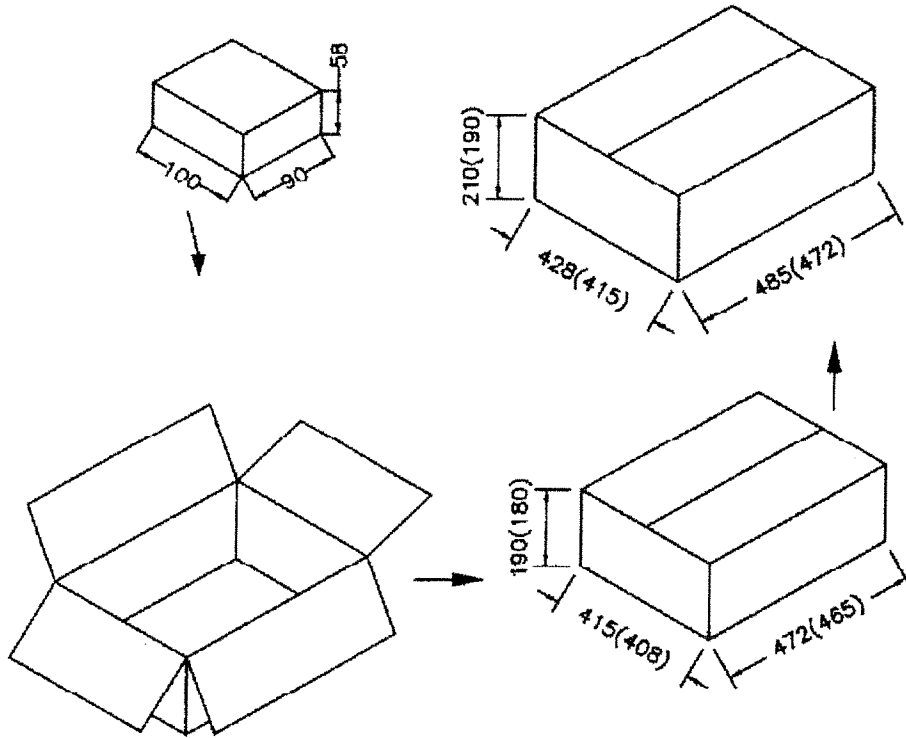



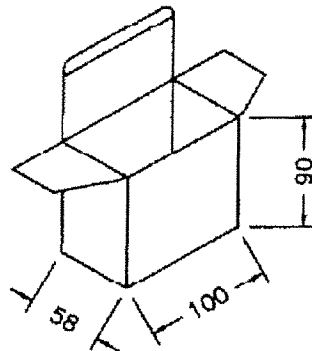
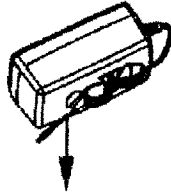
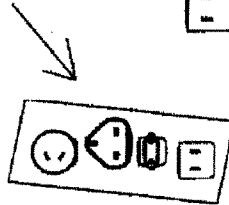
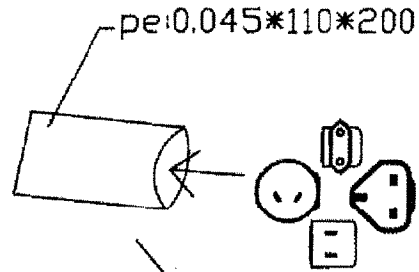

← White Box: NO.13

