

# M1MA151KT1, M1MA152KT1

Preferred Device

## Single Silicon Switching Diodes

These Silicon Epitaxial Planar Diodes are designed for use in ultra high speed switching applications. These devices are housed in the SC-59 package which is designed for low power surface mount applications.

### Features

- Fast  $t_{rr}$ , < 3.0 ns
- Low  $C_D$ , < 2.0 pF
- Available in 8 mm Tape and Reel
  - Use M1MA151/2KT1 to order the 7 inch/3000 unit reel.
  - Use M1MA151/2KT3 to order the 13 inch/10,000 unit reel.
- Pb-Free Packages are Available

### MAXIMUM RATINGS ( $T_A = 25^\circ\text{C}$ )

Rating		Symbol	Value	Unit
Reverse Voltage	M1MA151KT1	$V_R$	40	Vdc
	M1MA152KT1		80	
Peak Reverse Voltage	M1MA151KT1	$V_{RM}$	40	Vdc
	M1MA152KT1		80	
Forward Current		$I_F$	100	mAdc
Peak Forward Current		$I_{FM}$	225	mAdc
Peak Forward Surge Current		$I_{FSM}$ (Note 1)	500	mAdc

### THERMAL CHARACTERISTICS

Rating	Symbol	Max	Unit
Power Dissipation	$P_D$	200	mW
Junction Temperature	$T_J$	150	$^\circ\text{C}$
Storage Temperature	$T_{stg}$	-55 to +150	$^\circ\text{C}$

Maximum ratings are those values beyond which device damage can occur. Maximum ratings applied to the device are individual stress limit values (not normal operating conditions) and are not valid simultaneously. If these limits are exceeded, device functional operation is not implied, damage may occur and reliability may be affected.

1.  $t = 1 \text{ SEC}$



ON Semiconductor®

<http://onsemi.com>

## SC-59 PACKAGE SINGLE SILICON SWITCHING DIODES 40/80 V-100 mA SURFACE MOUNT

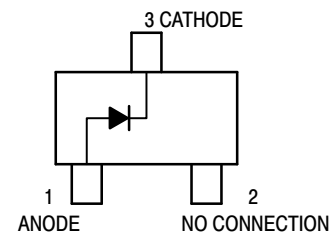

SC-59  
CASE 318D

### MARKING DIAGRAM

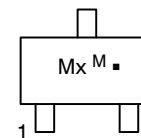

- Mx = Device Code
  - x = H for 151  
I for 152
  - M = Date Code\*
  - = Pb-Free Package
- (Note: Microdot may be in either location)

\*Date Code orientation may vary depending upon manufacturing location.

### ORDERING INFORMATION

See detailed ordering and shipping information in the package dimensions section on page 2 of this data sheet.

Preferred devices are recommended choices for future use and best overall value.

# M1MA151KT1, M1MA152KT1

## ELECTRICAL CHARACTERISTICS (T<sub>A</sub> = 25°C)

Characteristic		Symbol	Condition	Min	Max	Unit
Reverse Voltage Leakage Current	M1MA151KT1	I <sub>R</sub>	V <sub>R</sub> = 35 V	–	0.1	μA <sub>dc</sub>
	M1MA152KT1		V <sub>R</sub> = 75 V	–	0.1	
Forward Voltage		V <sub>F</sub>	I <sub>F</sub> = 100 mA	–	1.2	V <sub>dc</sub>
Reverse Breakdown Voltage	M1MA151KT1	V <sub>R</sub>	I <sub>R</sub> = 100 μA	40	–	V <sub>dc</sub>
	M1MA152KT1			80	–	
Diode Capacitance		C <sub>D</sub>	V <sub>R</sub> = 0, f = 1.0 MHz	–	2.0	pF
Reverse Recovery Time (Figure 1)		t <sub>rr</sub> (Note 2)	I <sub>F</sub> = 10 mA, V <sub>R</sub> = 6.0 V, R <sub>L</sub> = 100 Ω, I <sub>rr</sub> = 0.1 I <sub>R</sub>	–	3.0	ns

2. t<sub>rr</sub> Test Circuit

### RECOVERY TIME EQUIVALENT TEST CIRCUIT

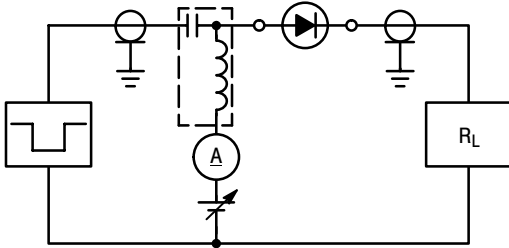

### INPUT PULSE

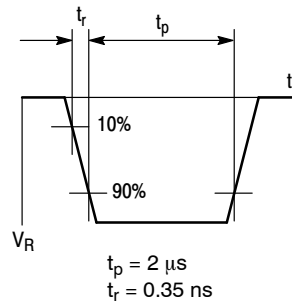

### OUTPUT PULSE

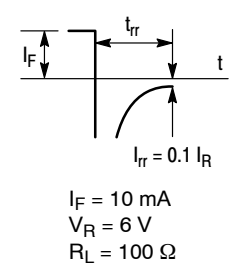

Figure 1. Reverse Recovery Time Equivalent Test Circuit

## ORDERING INFORMATION

Device	Package	Shipping†
M1MA151KT1	SC-59	3000 Units / Tape & Reel
M1MA151KT1G	SC-59 (Pb-Free)	3000 Units / Tape & Reel
M1MA152KT1	SC-59	3000 Units / Tape & Reel
M1MA152KT1G	SC-59 (Pb-Free)	3000 Units / Tape & Reel

†For information on tape and reel specifications, including part orientation and tape sizes, please refer to our Tape and Reel Packaging Specifications Brochure, BRD8011/D.

# MECHANICAL CASE OUTLINE

## PACKAGE DIMENSIONS

ON Semiconductor®



SC-59  
CASE 318D-04  
ISSUE H

DATE 28 JUN 2012

SCALE 2:1

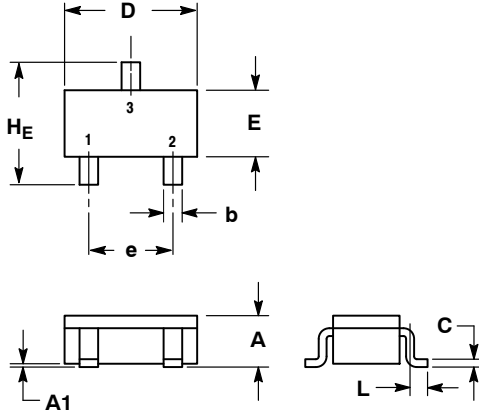

### SOLDERING FOOTPRINT\*

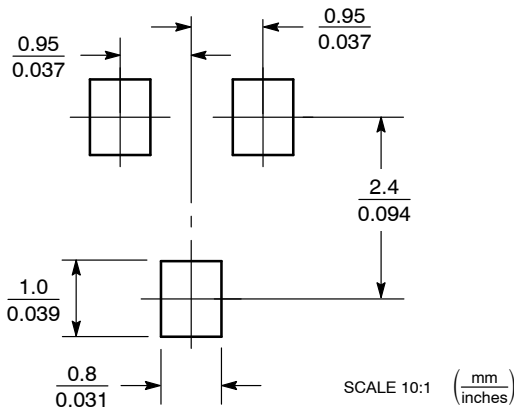

NOTES:

1. DIMENSIONING AND TOLERANCING PER ANSI Y14.5M, 1982.
2. CONTROLLING DIMENSION: MILLIMETER.

DIM	MILLIMETERS			INCHES		
	MIN	NOM	MAX	MIN	NOM	MAX
A	1.00	1.15	1.30	0.039	0.045	0.051
A1	0.01	0.06	0.10	0.001	0.002	0.004
b	0.35	0.43	0.50	0.014	0.017	0.020
c	0.09	0.14	0.18	0.003	0.005	0.007
D	2.70	2.90	3.10	0.106	0.114	0.122
E	1.30	1.50	1.70	0.051	0.059	0.067
e	1.70	1.90	2.10	0.067	0.075	0.083
L	0.20	0.40	0.60	0.008	0.016	0.024
HE	2.50	2.80	3.00	0.099	0.110	0.118

### GENERIC MARKING DIAGRAM

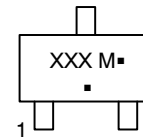

- XXX = Specific Device Code
- M = Date Code
- = Pb-Free Package\*

(\*Note: Microdot may be in either location)

\*This information is generic. Please refer to device data sheet for actual part marking. Pb-Free indicator, "G" or microdot "▪", may or may not be present.

- |   |  |  |
|---|--|--|
| STYLE 1:<br>PIN 1. BASE<br>2. EMITTER<br>3. COLLECTOR | STYLE 2:<br>PIN 1. ANODE<br>2. N.C.<br>3. CATHODE    | STYLE 3:<br>PIN 1. ANODE<br>2. ANODE<br>3. CATHODE         |
| STYLE 4:<br>PIN 1. CATHODE<br>2. N.C.<br>3. ANODE     | STYLE 5:<br>PIN 1. CATHODE<br>2. CATHODE<br>3. ANODE | STYLE 6:<br>PIN 1. ANODE<br>2. CATHODE<br>3. ANODE/CATHODE |

\*For additional information on our Pb-Free strategy and soldering details, please download the ON Semiconductor Soldering and Mounting Techniques Reference Manual, SOLDERRM/D.

DOCUMENT NUMBER:	98ASB42664B	Electronic versions are uncontrolled except when accessed directly from the Document Repository. Printed versions are uncontrolled except when stamped "CONTROLLED COPY" in red.
DESCRIPTION:	SC-59	PAGE 1 OF 1

ON Semiconductor and ON are trademarks of Semiconductor Components Industries, LLC dba ON Semiconductor or its subsidiaries in the United States and/or other countries. ON Semiconductor reserves the right to make changes without further notice to any products herein. ON Semiconductor makes no warranty, representation or guarantee regarding the suitability of its products for any particular purpose, nor does ON Semiconductor assume any liability arising out of the application or use of any product or circuit, and specifically disclaims any and all liability, including without limitation special, consequential or incidental damages. ON Semiconductor does not convey any license under its patent rights nor the rights of others.

**onsemi**, **Onsemi**, and other names, marks, and brands are registered and/or common law trademarks of Semiconductor Components Industries, LLC dba "**onsemi**" or its affiliates and/or subsidiaries in the United States and/or other countries. **onsemi** owns the rights to a number of patents, trademarks, copyrights, trade secrets, and other intellectual property. A listing of **onsemi**'s product/patent coverage may be accessed at [www.onsemi.com/site/pdf/Patent-Marking.pdf](http://www.onsemi.com/site/pdf/Patent-Marking.pdf). **onsemi** reserves the right to make changes at any time to any products or information herein, without notice. The information herein is provided "as-is" and **onsemi** makes no warranty, representation or guarantee regarding the accuracy of the information, product features, availability, functionality, or suitability of its products for any particular purpose, nor does **onsemi** assume any liability arising out of the application or use of any product or circuit, and specifically disclaims any and all liability, including without limitation special, consequential or incidental damages. Buyer is responsible for its products and applications using **onsemi** products, including compliance with all laws, regulations and safety requirements or standards, regardless of any support or applications information provided by **onsemi**. "Typical" parameters which may be provided in **onsemi** data sheets and/or specifications can and do vary in different applications and actual performance may vary over time. All operating parameters, including "Typicals" must be validated for each customer application by customer's technical experts. **onsemi** does not convey any license under any of its intellectual property rights nor the rights of others. **onsemi** products are not designed, intended, or authorized for use as a critical component in life support systems or any FDA Class 3 medical devices or medical devices with a same or similar classification in a foreign jurisdiction or any devices intended for implantation in the human body. Should Buyer purchase or use **onsemi** products for any such unintended or unauthorized application, Buyer shall indemnify and hold **onsemi** and its officers, employees, subsidiaries, affiliates, and distributors harmless against all claims, costs, damages, and expenses, and reasonable attorney fees arising out of, directly or indirectly, any claim of personal injury or death associated with such unintended or unauthorized use, even if such claim alleges that **onsemi** was negligent regarding the design or manufacture of the part. **onsemi** is an Equal Opportunity/Affirmative Action Employer. This literature is subject to all applicable copyright laws and is not for resale in any manner.

---

## ADDITIONAL INFORMATION

### TECHNICAL PUBLICATIONS:

Technical Library: [www.onsemi.com/design/resources/technical-documentation](http://www.onsemi.com/design/resources/technical-documentation)  
onsemi Website: [www.onsemi.com](http://www.onsemi.com)

### ONLINE SUPPORT: [www.onsemi.com/support](http://www.onsemi.com/support)

For additional information, please contact your local Sales Representative at [www.onsemi.com/support/sales](http://www.onsemi.com/support/sales)