

# ISL9R860PF2

## 8 A, 600 V, STEALTH™ Diode

### Description

The ISL9R860PF2 is a STEALTH diode optimized for low loss performance in high frequency hard switched applications. The STEALTH family exhibits low reverse recovery current ( $I_{rr}$ ) and exceptionally soft recovery under typical operating conditions. This device is intended for use as a free wheeling or boost diode in power supplies and other power switching applications. The low  $I_{rr}$  and short  $t_a$  phase reduce loss in switching transistors. The soft recovery minimizes ringing, expanding the range of conditions under which the diode may be operated without the use of additional snubber circuitry. Consider using the STEALTH diode with an SMPS IGBT to provide the most efficient and highest power density design at lower cost.

### Features

- Stealth Recovery  $t_{rr} = 28$  ns (@  $I_F = 8$  A)
- Max Forward Voltage,  $V_F = 2.4$  V (@  $T_C = 25^\circ\text{C}$ )
- 600 V Reverse Voltage and High Reliability
- Avalanche Energy Rated
- This Device is Pb-Free and is RoHS Compliant

### Applications

- Switch Mode Power Supplies
- Hard Switched PFC Boost Diode
- UPS Free Wheeling Diode
- Motor Drive FWD
- SMPS FWD
- Snubber Diode



ON Semiconductor®

[www.onsemi.com](http://www.onsemi.com)

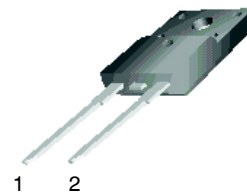
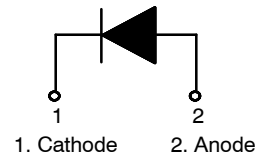

TO-220, 2-Lead  
CASE 221AS

### MARKING DIAGRAM

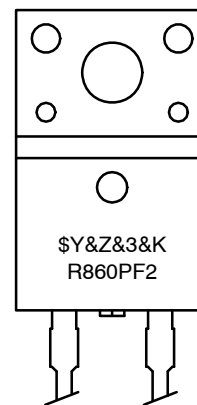

\$Y	= ON Semiconductor Logo
&Z&3	= Data Code (Year & Week)
&K	= Lot
R860PF2	= Specific Device Code

### ORDERING INFORMATION

See detailed ordering and shipping information on page 3 of this data sheet.

# ISL9R860PF2

## MAXIMUM RATINGS $T_C = 25^\circ\text{C}$ unless otherwise noted

Symbol	Parameter	Rating	Units
$V_{RRM}$	Peak Repetitive Reverse Voltage	600	V
$V_{RWM}$	Working Peak Reverse Voltage	600	V
$V_R$	DC Blocking Voltage	600	V
$I_{F(AV)}$	Average Rectified Forward Current ( $T_C = 75^\circ\text{C}$ )	8	A
$I_{FRM}$	Repetitive Peak Surge Current (20 kHz Square Wave)	16	A
$I_{FSM}$	Nonrepetitive Peak Surge Current (Halfwave 1 Phase 60 Hz)	100	A
$P_D$	Power Dissipation	26	W
$E_{AVL}$	Avalanche Energy (1 A, 40 mH)	20	mJ
$T_J, T_{STG}$	Operating and Storage Temperature Range	-55 to 175	$^\circ\text{C}$
$T_L$	Maximum Temperature for Soldering Leads at 0.063 in (1.6 mm) from Case for 10 s	300	$^\circ\text{C}$

Stresses exceeding those listed in the Maximum Ratings table may damage the device. If any of these limits are exceeded, device functionality should not be assumed, damage may occur and reliability may be affected.

## ELECTRICAL CHARACTERISTICS $T_C = 25^\circ\text{C}$ unless otherwise noted

Symbol	Parameter	Test Condition	Min	Typ	Max	Unit
--------	-----------	----------------	-----	-----	-----	------

### OFF STATE CHARACTERISTICS

$I_R$	Instantaneous Reverse Current	$V_R = 600\text{ V}$	$T_C = 25^\circ\text{C}$	-	-	100	$\mu\text{A}$
			$T_C = 125^\circ\text{C}$	-	-	1.0	mA

### ON STATE CHARACTERISTICS

$V_F$	Instantaneous Forward Voltage	$I_F = 8\text{ A}$	$T_C = 25^\circ\text{C}$	-	2.0	2.4	V
			$T_C = 125^\circ\text{C}$	-	1.6	2.0	V

### DYNAMIC CHARACTERISTICS

$C_J$	Junction Capacitance	$V_R = 10\text{ V}, I_F = 0\text{ A}$	-	30	-	pF
-------	----------------------	---------------------------------------	---	----	---	----

### SWITCHING CHARACTERISTICS

$t_{rr}$	Reverse Recovery Time	$I_F = 1\text{ A}, di_F/dt = 100\text{ A}/\mu\text{s}, V_R = 30\text{ V}$	-	18	25	ns
			$I_F = 8\text{ A}, di_F/dt = 100\text{ A}/\mu\text{s}, V_R = 30\text{ V}$	-	21	30
$t_{rr}$	Reverse Recovery Time	$I_F = 8\text{ A}, di_F/dt = 200\text{ A}/\mu\text{s}, V_R = 390\text{ V}, T_C = 25^\circ\text{C}$	-	28	-	ns
$I_{rr}$	Maximum Reverse Recovery Current		-	3.2	-	A
$Q_{rr}$	Reverse Recovery Charge		-	50	-	nC
$t_{rr}$	Reverse Recovery Time		$I_F = 8\text{ A}, di_F/dt = 200\text{ A}/\mu\text{s}, V_R = 390\text{ V}, T_C = 125^\circ\text{C}$	-	77	-
S	Softness Factor ( $t_b/t_a$ )	$I_F = 8\text{ A}, di_F/dt = 200\text{ A}/\mu\text{s}, V_R = 390\text{ V}, T_C = 125^\circ\text{C}$	-	3.7	-	
$I_{rr}$	Maximum Reverse Recovery Current		-	3.4	-	A
$Q_{rr}$	Reverse Recovery Charge		-	150	-	nC
$t_{rr}$	Reverse Recovery Time	$I_F = 8\text{ A}, di_F/dt = 600\text{ A}/\mu\text{s}, V_R = 390\text{ V}, T_C = 125^\circ\text{C}$	-	53	-	ns
S	Softness Factor ( $t_b/t_a$ )		-	2.5	-	
$I_{rr}$	Maximum Reverse Recovery Current		-	6.5	-	A
$Q_{rr}$	Reverse Recovery Charge		-	195	-	nC
$di_M/dt$	Maximum di/dt during $t_b$		-	500	-	A/ $\mu\text{s}$

Product parametric performance is indicated in the Electrical Characteristics for the listed test conditions, unless otherwise noted. Product performance may not be indicated by the Electrical Characteristics if operated under different conditions.

# ISL9R860PF2

## THERMAL CHARACTERISTICS $T_C = 25^\circ\text{C}$ unless otherwise noted

Symbol	Parameter	Test Condition	Min	Typ	Max	Unit
$R_{\theta JC}$	Thermal Resistance, Junction to Case		-	-	4.8	$^\circ\text{C}/\text{W}$
$R_{\theta JA}$	Thermal Resistance, Junction to Ambient	TO-220F	-	-	70	$^\circ\text{C}/\text{W}$

## PACKAGE MARKING AND ORDERING INFORMATION

Part Number	Top Mark	Package	Packing Method	Reel Size	Tape Width	Quantity
ISL9R860PF2	R860PF2	TO-220F-2L	Tube	N/A	N/A	50

## TYPICAL CHARACTERISTICS

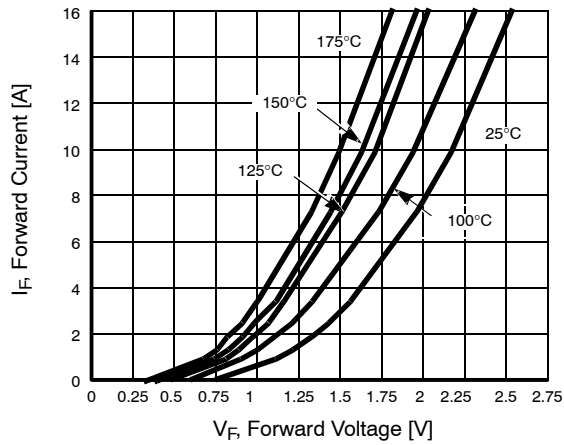

Figure 1. Forward Current vs. Forward Voltage

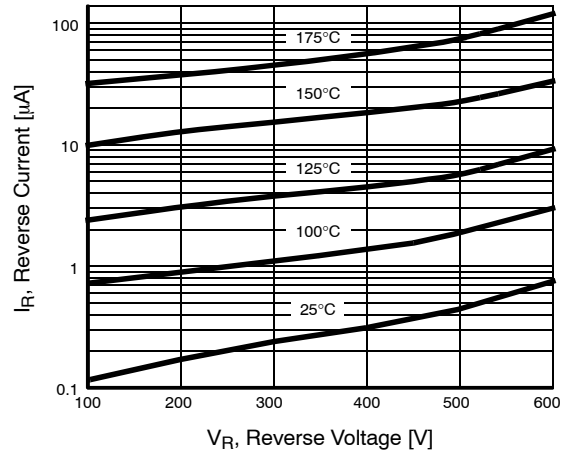

Figure 2. Reverse Current vs. Reverse Voltage

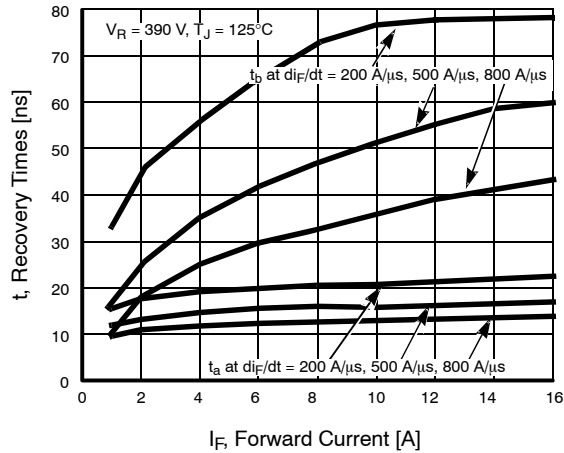

Figure 3.  $t_a$  and  $t_b$  Curves vs. Forward Current

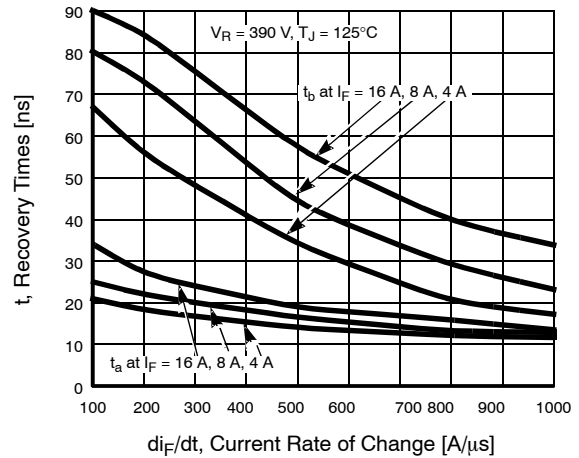
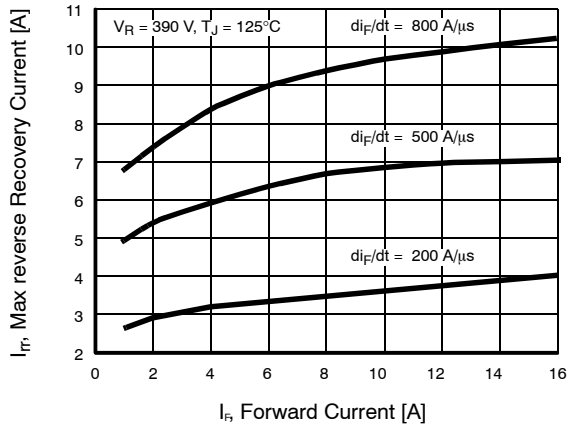

Figure 4.  $t_a$  and  $t_b$  Curves vs.  $di_F/dt$

# ISL9R860PF2

## TYPICAL CHARACTERISTICS (continued)



**Figure 5. Maximum Reverse Recovery Current vs. Forward Current**

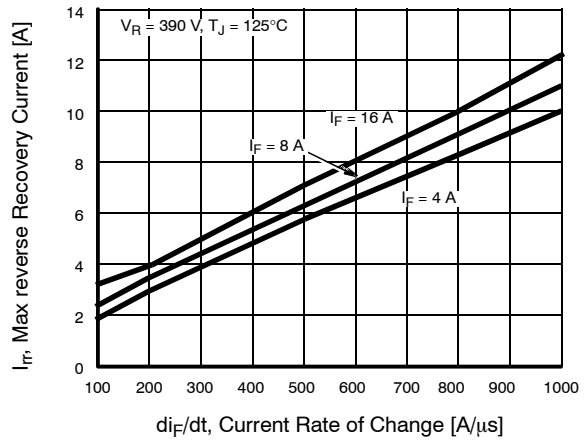

**Figure 6. Maximum Reverse Recovery Current vs.  $di_F/dt$**

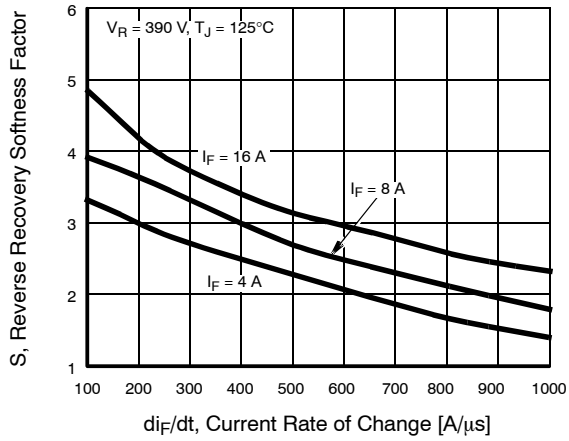

**Figure 7. Reverse Recovery Softness Factor vs.  $di_F/dt$**

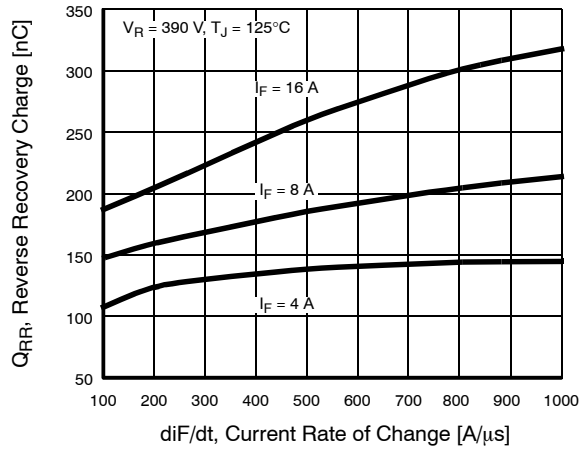

**Figure 8. Reverse Recovery Charge vs.  $di_F/dt$**

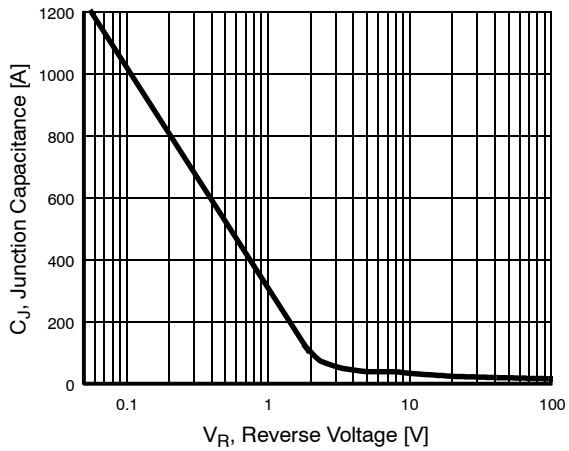

**Figure 9. Junction Capacitance vs. Reverse Voltage**

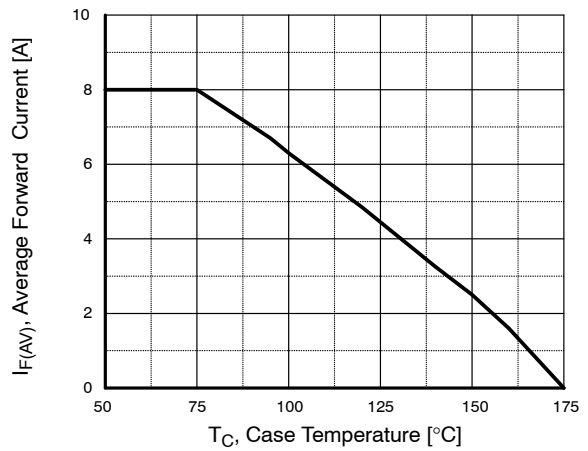

**Figure 10. DC Current Derating Curve**

# ISL9R860PF2

## TYPICAL CHARACTERISTICS (continued)

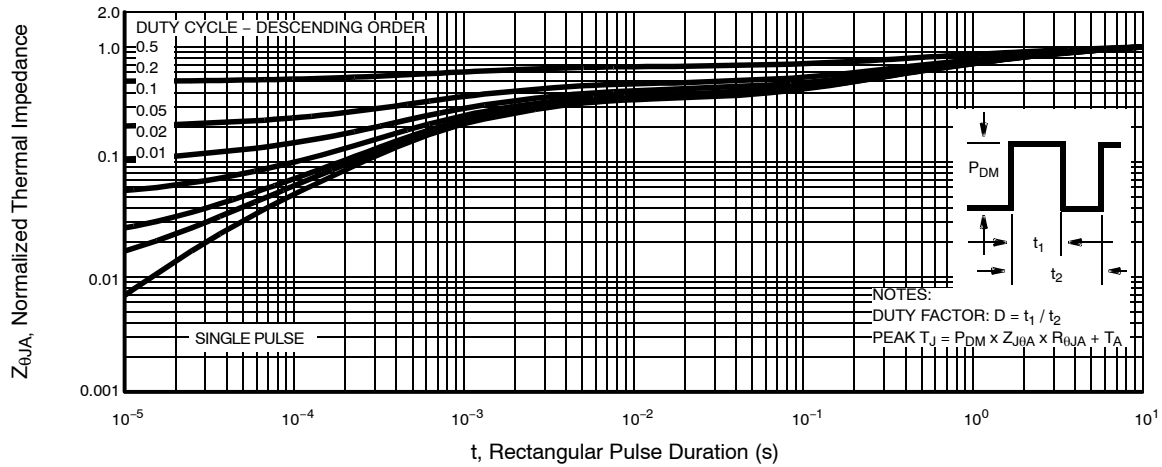

Figure 11. Normalized Maximum Transient Thermal Impedance

## TEST CIRCUIT AND WAVEFORMS

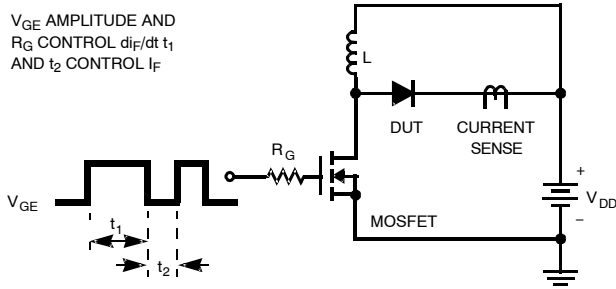

Figure 12.  $t_{rr}$  Test Circuit

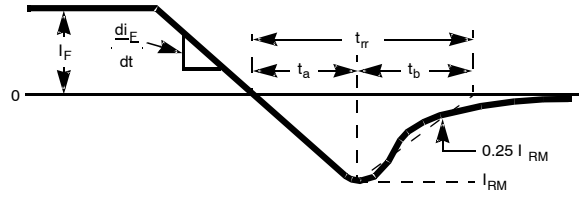

Figure 13.  $t_{rr}$  Waveforms and Definitions

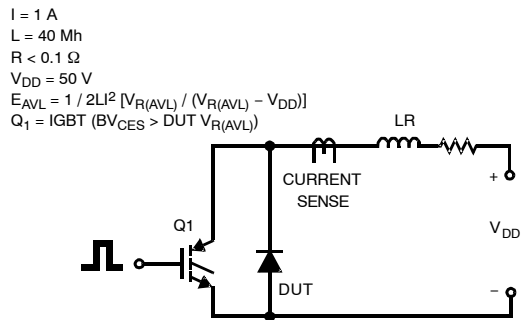

Figure 14. Avalanche Energy Test Circuit

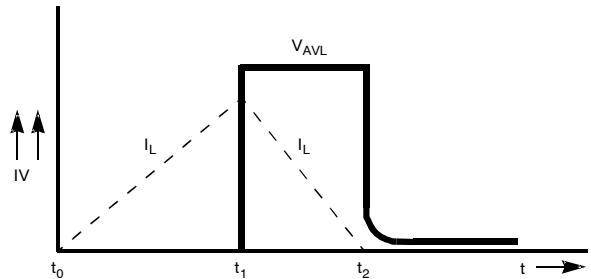

Figure 15. Avalanche Current and Voltage Waveforms

STEALTH is trademark of Semiconductor Components Industries, LLC (SCILLC) or its subsidiaries in the United States and/or other countries.

# MECHANICAL CASE OUTLINE

## PACKAGE DIMENSIONS

ON Semiconductor®



TO-220 Fullpack, 2-Lead / TO-220F-2FS  
CASE 221AS  
ISSUE O

DATE 29 FEB 2012

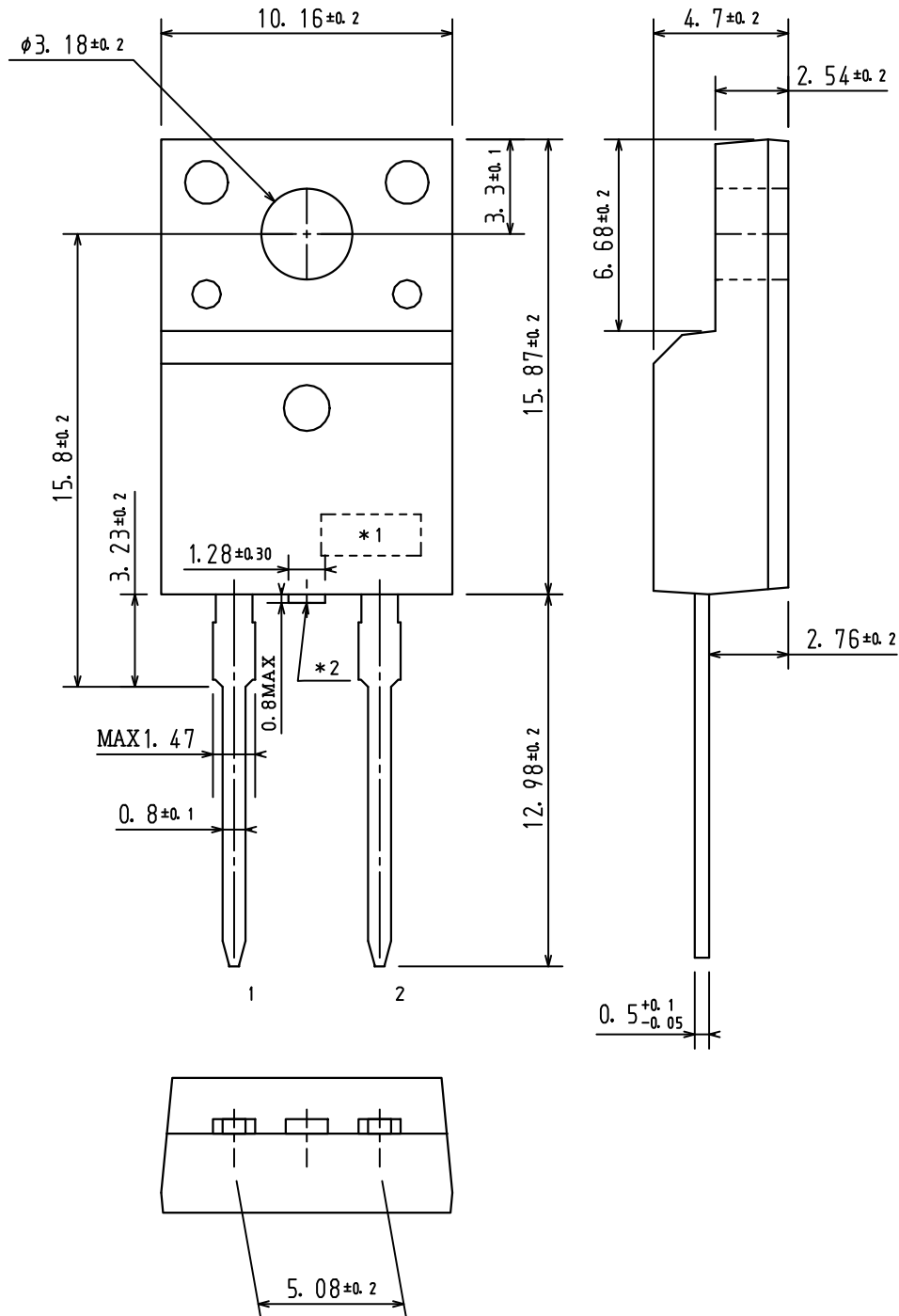

<b>DOCUMENT NUMBER:</b>	<b>98AON67438E</b>	Electronic versions are uncontrolled except when accessed directly from the Document Repository. Printed versions are uncontrolled except when stamped "CONTROLLED COPY" in red.
<b>DESCRIPTION:</b>	<b>TO-220 FULLPACK, 2-LEAD / TO-220F-2FS</b>	<b>PAGE 1 OF 1</b>

ON Semiconductor and are trademarks of Semiconductor Components Industries, LLC dba ON Semiconductor or its subsidiaries in the United States and/or other countries. ON Semiconductor reserves the right to make changes without further notice to any products herein. ON Semiconductor makes no warranty, representation or guarantee regarding the suitability of its products for any particular purpose, nor does ON Semiconductor assume any liability arising out of the application or use of any product or circuit, and specifically disclaims any and all liability, including without limitation special, consequential or incidental damages. ON Semiconductor does not convey any license under its patent rights nor the rights of others.

**onsemi**, **Onsemi**, and other names, marks, and brands are registered and/or common law trademarks of Semiconductor Components Industries, LLC dba "**onsemi**" or its affiliates and/or subsidiaries in the United States and/or other countries. **onsemi** owns the rights to a number of patents, trademarks, copyrights, trade secrets, and other intellectual property. A listing of **onsemi**'s product/patent coverage may be accessed at [www.onsemi.com/site/pdf/Patent-Marking.pdf](http://www.onsemi.com/site/pdf/Patent-Marking.pdf). **onsemi** reserves the right to make changes at any time to any products or information herein, without notice. The information herein is provided "as-is" and **onsemi** makes no warranty, representation or guarantee regarding the accuracy of the information, product features, availability, functionality, or suitability of its products for any particular purpose, nor does **onsemi** assume any liability arising out of the application or use of any product or circuit, and specifically disclaims any and all liability, including without limitation special, consequential or incidental damages. Buyer is responsible for its products and applications using **onsemi** products, including compliance with all laws, regulations and safety requirements or standards, regardless of any support or applications information provided by **onsemi**. "Typical" parameters which may be provided in **onsemi** data sheets and/or specifications can and do vary in different applications and actual performance may vary over time. All operating parameters, including "Typicals" must be validated for each customer application by customer's technical experts. **onsemi** does not convey any license under any of its intellectual property rights nor the rights of others. **onsemi** products are not designed, intended, or authorized for use as a critical component in life support systems or any FDA Class 3 medical devices or medical devices with a same or similar classification in a foreign jurisdiction or any devices intended for implantation in the human body. Should Buyer purchase or use **onsemi** products for any such unintended or unauthorized application, Buyer shall indemnify and hold **onsemi** and its officers, employees, subsidiaries, affiliates, and distributors harmless against all claims, costs, damages, and expenses, and reasonable attorney fees arising out of, directly or indirectly, any claim of personal injury or death associated with such unintended or unauthorized use, even if such claim alleges that **onsemi** was negligent regarding the design or manufacture of the part. **onsemi** is an Equal Opportunity/Affirmative Action Employer. This literature is subject to all applicable copyright laws and is not for resale in any manner.

## ADDITIONAL INFORMATION

### TECHNICAL PUBLICATIONS:

Technical Library: [www.onsemi.com/design/resources/technical-documentation](http://www.onsemi.com/design/resources/technical-documentation)  
onsemi Website: [www.onsemi.com](http://www.onsemi.com)

### ONLINE SUPPORT: [www.onsemi.com/support](http://www.onsemi.com/support)

For additional information, please contact your local Sales Representative at [www.onsemi.com/support/sales](http://www.onsemi.com/support/sales)