



### Main

Range of Product	OsiSense XM
Pressure sensor type	Electromechanical pressure sensor
Pressure sensor name	FTG
Pressure Rating	66.72 psi (4.6 bar)
Fluid connection type	G 1/4 (female) ISO 228
Controlled fluid	Fresh water 32...158 °F (0...70 °C) Sea water 32...158 °F (0...70 °C)
Cable entry	2 cable entries with grommet
Contacts type and composition	2 NC snap action
Product Specific Application	-
Pressure switch type of operation	Detection of single threshold
Line Rated Current	10 A 250 V AC EN 60730-1
Electrical connection	Screw-clamp terminals 1 x 1...2 x 2 mm <sup>2</sup>
Short-circuit protection	20 A cartridge fuse gG
Scale type	Fixed differential
Setting	Internal
Local display	Without
Electrical circuit type	Power circuit

### Complementary

Materials in contact with fluid	Zinc plated steel Nylon 6/6 Nitrile
Enclosure Material	PS
Operating position	Any position
Motor power kW	0.75 KW/1 Hp at 110 V AC, 1 phase 1.1 KW/1.5 Hp at 110 V AC, 3 phase 1.5 KW/2 Hp at 400 V AC, 1 phase 1.1 KW/1.5 Hp at 230 V AC, 1 phase 1.5 KW/2 Hp at 230 V AC, 3 phase 1.5 kW/2 hp at 400 V AC, 3 phase
Adjustable range of switching point on falling pressure	4.35...44.96 psi (0.3...3.1 bar)
Adjustable range of switching point on rising pressure	20.31...66.72 psi (1.4...4.6 bar)
Maximum permissible accidental pressure	116.03 psi (8 bar)
Maximum permissible pressure - per cycle	83.40 psi (5.75 bar)
Destruction pressure	290.08 psi (20 bar)
Pressure actuator	Diaphragm
Electrical durability	40000 cycles 10 cyc/mn
Mechanical durability	400000 cycles
Terminal block type	4 terminals
Natural differential at low setting	15.95 psi (1.1 bar)
Natural differential at middle setting	18.85 psi (1.3 bar)
Natural differential at high setting	21.76 psi (1.5 bar)
Maximum operating rate	10 cyc/mn
[Ui] rated insulation voltage	500 V EN/IEC 60947-1
[Uimp] rated impulse withstand voltage	6 kV EN/IEC 60947-1

Net Weight	0.75 lb(US) (0.34 kg)
Repeat accuracy	2 %
Terminals description ISO n°1	(1-2)NC (3-4)NC
Depth	4.02 in (102 mm)
Height	3.78 in (96 mm)
Width	2.83 in (72 mm)

## Environment

Standards	CE EN/IEC 60730
Ambient Air Temperature for Operation	32...113 °F (0...45 °C)
Ambient Air Temperature for Storage	-22...176 °F (-30...80 °C)
Protective treatment	TC
Electrical shock protection class	Class I IEC 536
IP degree of protection	IP20 conforming to EN/IEC 60529





## Ordering and shipping details

Category	18407-WORLD SERVICE PARTS(SENSORS)
Discount Schedule	T
GTIN	3389110524338
Nbr. of units in pkg.	1
Package weight(Lbs)	13.05 oz (370.0 g)
Returnability	No
Country of origin	MX

## Packing Units

Unit Type of Package 1	PCE
Package 1 Height	21.26 in (54 cm)
Package 1 width	21.26 in (54 cm)
Package 1 Length	12.60 in (32 cm)
Unit Type of Package 2	CAR
Number of Units in Package 2	1
Package 2 Weight	13.05 oz (370.0 g)
Package 2 Height	2.83 in (7.2 cm)
Package 2 width	4.06 in (10.3 cm)
Package 2 Length	4.13 in (10.5 cm)

## Offer Sustainability

California proposition 65	WARNING: This product can expose you to chemicals including: Diisononyl phthalate (DINP), which is known to the State of California to cause cancer, and Di-isodecyl phthalate (DIDP), which is known to the State of California to cause birth defects or other reproductive harm. For more information go to <a href="http://www.P65Warnings.ca.gov">www.P65Warnings.ca.gov</a>
EU RoHS Directive	Pro-active compliance (Product out of EU RoHS legal scope)  <a href="#">EU RoHS Declaration</a>
Mercury free	Yes
RoHS exemption information	 Yes
Environmental Disclosure	 <a href="#">Product Environmental Profile</a>
Circularity Profile	 <a href="#">End Of Life Information</a>

## Contractual warranty

Warranty	18 months
----------	-----------

Dimensions

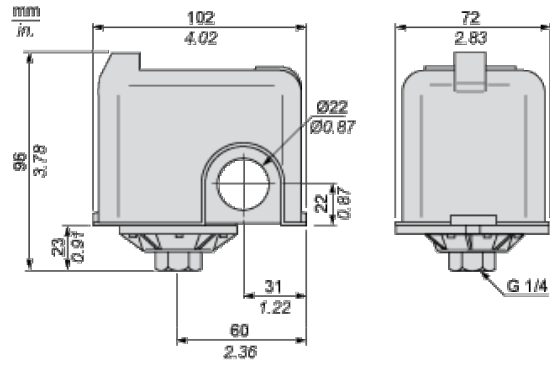

---

## Wiring Diagram

---

### Connections



Curves

Operating Curves

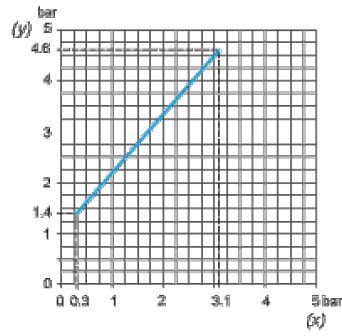

- (y) Rising pressure
- (x) Falling pressure

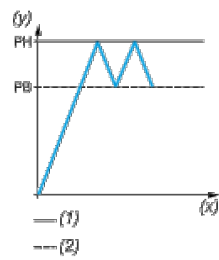

- (y) Pressure
- (x) Time
- (1) Adjustable value
- (2) Non adjustable value