

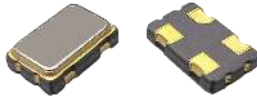

# PLETRONICS *PRONTO*<sup>TM</sup> QM55L Series CMOS Configurable Clock Oscillator



QM55L  
5.0 x 3.2 x 1.2 mm  
LCC Ceramic Package

## Features

- A configurable quartz crystal controlled precision square wave oscillator
- CMOS Output (will interface with TTL devices)
- Enable/Disable Function (low standby power option)
- Low Jitter
- 1.8V, 2.5V, or 3.3V nominal Supply Voltage
- 1-160 MHz Frequency Range (1-125MHz at 1.8V)
- Fundamental crystal

## Applications

Driving A/Ds, D/As, FPGAs  
Digital Video  
Ethernet, GbE  
Medical  
Storage Area Networking  
COTS  
Broad Band Access  
SONET/ SDH/ DWDM  
Test & Measurement

## Electrical Characteristics

Parameter	Min	Typ	Max	Unit	Condition
Frequency Range <sup>2</sup>	1	-	160	MHz	(1.8V frequency range 1-125MHz)
Frequency Stability <sup>2</sup> ± 20 = <b>20</b> , ± 25 = <b>44</b> , ± 50 = <b>45</b>	±20	-	±50	ppm	For all supply voltages, load changes, aging for 1 year at 25°C ± 2°C, shock, vibration and temperatures
Operating Temperature Range <sup>2</sup>	-10 -20 -40	- - -	+70 +70 +85	°C	Standard range Extended range <b>C</b> option Extended range <b>E</b> option
Supply Voltage <sup>1,2</sup> V <sub>CC</sub>	1.8	-	3.3	V	± 5%, See Part Number options on page 3
Supply Current I <sub>CC</sub>	-	-	-	mA	See Page 2
Output Waveform	CMOS				Load = 15 pF
Duty Cycle	45	-	55	%	See Load Circuit and waveform page
Output V <sub>HIGH</sub>	90	-	-	%V <sub>CC</sub>	
Output V <sub>LOW</sub>	-	-	10	%V <sub>CC</sub>	
Output T <sub>RISE</sub> and T <sub>FALL</sub>	-	-	2	ns	
Startup Time	-	-	8	ms	Time for output to reach specified frequency
V <sub>DISABLE</sub>	-	-	30	%	Of V <sub>CC</sub> applied to Pad 1
V <sub>ENABLE</sub>	70	-			
Enable Time	-	-	100	ns	Time for output to reach a logic state
Disable Time	-	-	100	ns	Time for output to reach a high Z state
Disable Current	- -	- 0.4	- -	mA	Enable/Disable: Pad 1 low, output disabled; See page 2 Standby option: Pad 1 low, output disabled, oscillator shutdown
Jitter	-	1.0	-	ps	12 kHz to 20 MHz @ 110 MHz
Storage Temperature Range	-55	-	+125	°C	

Notes: Specifications with Pad 1 E/D open circuit

<sup>1</sup> Place an appropriate power supply bypass capacitor next to device for correct operation

<sup>2</sup> Specified by part number



# PLETRONICS *PRONTO*<sup>™</sup> QM55L Series CMOS Configurable Clock Oscillator

Parameter	Min	Typ	Max	Unit	Condition Vcc = 3.3V	
Supply Current I <sub>cc</sub>			27 30 35	mA	1MHz ≤ Fo < 75MHz 75MHz ≤ Fo < 125MHz 125MHz ≤ Fo < 160MHz	15pF load

Parameter	Min	Typ	Max	Unit	Condition Vcc = 2.5V	
Supply Current I <sub>cc</sub>			27 30 35	mA	1MHz ≤ Fo < 75MHz 75MHz ≤ Fo < 125MHz 125MHz ≤ Fo ≤ 160MHz	15pF load

Parameter	Min	Typ	Max	Unit	Condition Vcc = 1.8V	
Supply Current I <sub>cc</sub>			25	mA	1MHz ≤ Fo ≤ 125MHz	15pF load



# PLETRONICS *PRONTO*<sup>TM</sup> QM55L Series CMOS Configurable Clock Oscillator

## Part Number\*\*

Series Model	Frequency Stability		Operating Temperature Range	Supply Voltage V <sub>CC</sub>	Frequency in MHz
QM55	45	L	E	V	- 125.0M
	45 = ± 50 ppm (STD) 44 = ± 25 ppm 20 = ± 20 ppm		Blank = -10 to +70°C (STD) C = -20 to +70°C E = -40 to +85°C	X = 1.8V ± 5% W = 2.5V ± 5% V = 3.3V ± 5%	1 - 160 MHz (1.8V: 1-125MHz)

\*\* A custom part number is assigned for parts using the standby option

## Device Marking



PRONTO = Pletronics Model  
YMD = Date Code, Year Month Day (see below)  
xxx = internal factory codes

Note: Specifications such as frequency stability, supply voltage and operating temperature range, etc. are not identified from marking.  
External packaging labels and packing list will correctly identify the ordered Pletronics part number.

Codes for Date Code YMD (Year Month Day)

Code	2	3	4	5	6	Code	A	B	C	D	E	F	G	H	J	K	L	M
Year	2022	2023	2024	2025	2026	Month	JAN	FEB	MAR	APR	MAY	JUN	JUL	AUG	SEP	OCT	NOV	DEC

Code	1	2	3	4	5	6	7	8	9	A	B	C	D	E	F	G
Day	1	2	3	4	5	6	7	8	9	10	11	12	13	14	15	16
Code	H	J	K	L	M	N	P	R	T	U	V	W	X	Y	Z	
Day	17	18	19	20	21	22	23	24	25	26	27	28	29	30	31	

## Package Labeling

P/N Label is 1" x 2.6" (25.4mm x 66.7mm)  
Font is Courier New  
Bar code is 39-Full ASCII

RoHS Label is 1" x 2.6" (25.4mm x 66.7mm)  
Font is Arial

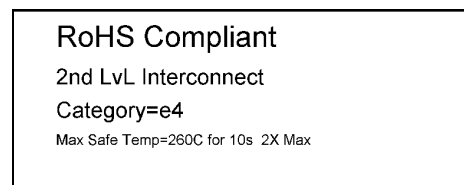

Pletronics Inc. certifies this device is in accordance with the RoHS and REACH directives.

Pletronics Inc. guarantees the device does not contain the following: Cadmium, Hexavalent Chromium, Lead, Mercury, PBB's, PBDE's  
Weight of the Device: 0.057 grams  
Moisture Sensitivity Level: 1 As defined in J-STD-020D  
Second Level Interconnect code: e4



# PLETRONICS *PRONTO*™ QM55L Series CMOS Configurable Clock Oscillator

## Mechanical Dimensions (mm)

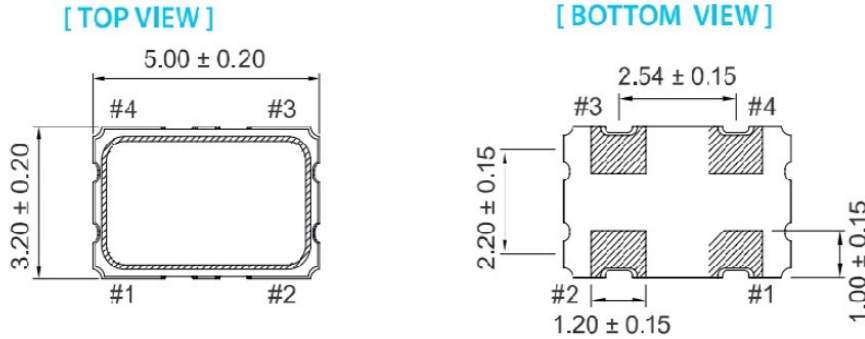

[ SIDE VIEW ]

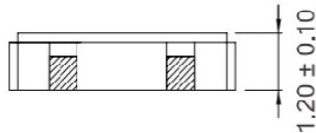

Pin#	Function
1	Tri-state
2	GND
3	Output
4	VDD

### Enable/Disable

Pin 1	Output
Open	Active
Logic '1'	Active
Ground	Tri-state

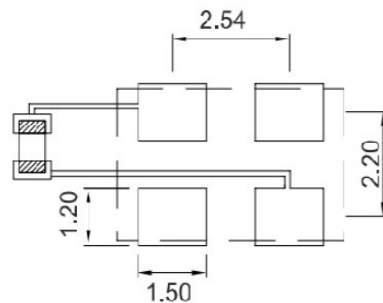

### Pad Layout mm shown

Disclaimer: Recommended layout shown. Adjust layout as needed for individual process requirements.

To ensure optimal oscillator performance, place a by-pass capacitor of 0.01~0.1µF as close to the part as possible between Vdd and GND pads.

**Contacts (pads): Gold (0.3 to 1.0 µm) over Nickel (1.27 to 8.89 µm)**

For Optimum Jitter Performance, Pletronics recommends:

- A ground plane under the device
- Do not route large transient signals (both current and voltage) under the device
- Do not place near a large magnetic field such as a high frequency switching power supply
- Do not place near piezoelectric buzzers or mechanical fans



# PLETRONICS *PRONTO*™ QM55L Series CMOS Configurable Clock Oscillator

## Electrical Test / Load Circuit

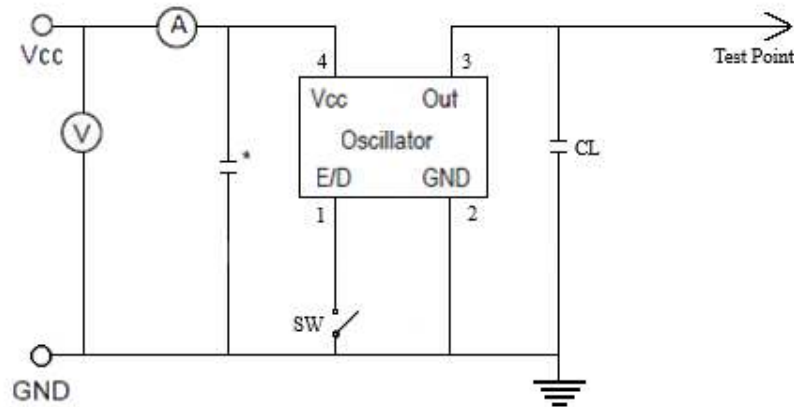

Notes:  
 CL: 15pF Includes the input capacitance of oscilloscope  
 \* 0.01~0.1 $\mu$ F external by-pass filter is recommended

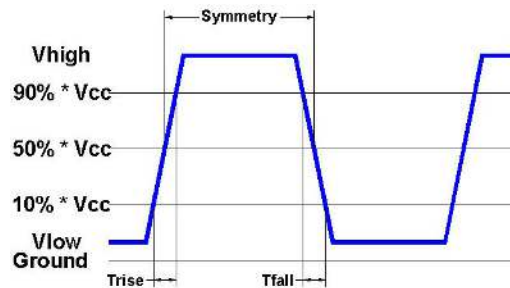

## Environmental / ESD Ratings

Reliability: Environmental

Parameter	Condition
Mechanical Shock	MIL-STD-883, Method 2002, Condition B
Vibration	MIL-STD-883, Method 2007, Condition A
Solderability	IPC J-STD-002
Thermal Cycle	MIL-STD-883 Method 1010, Condition B

ESD Rating

Model	Min. Voltage	Condition
Human Body Model	2000V	MIL-STD-883 3015.7
Machine Model	200V	EIAJ ED-4701/304

Absolute Maximum Ratings

Parameter	Unit
V <sub>CC</sub> Supply Voltage	-0.5V to +7.0V
V <sub>i</sub> Input Voltage	-0.5V to V <sub>CC</sub> + 0.5V
V <sub>o</sub> Output Voltage	-0.5V to V <sub>CC</sub> + 0.5V

### Thermal Characteristics:

The maximum die or junction temperature is 125°C



# PLETRONICS *PRONTO*<sup>™</sup> QM55L Series CMOS Configurable Clock Oscillator

## Reflow Cycle

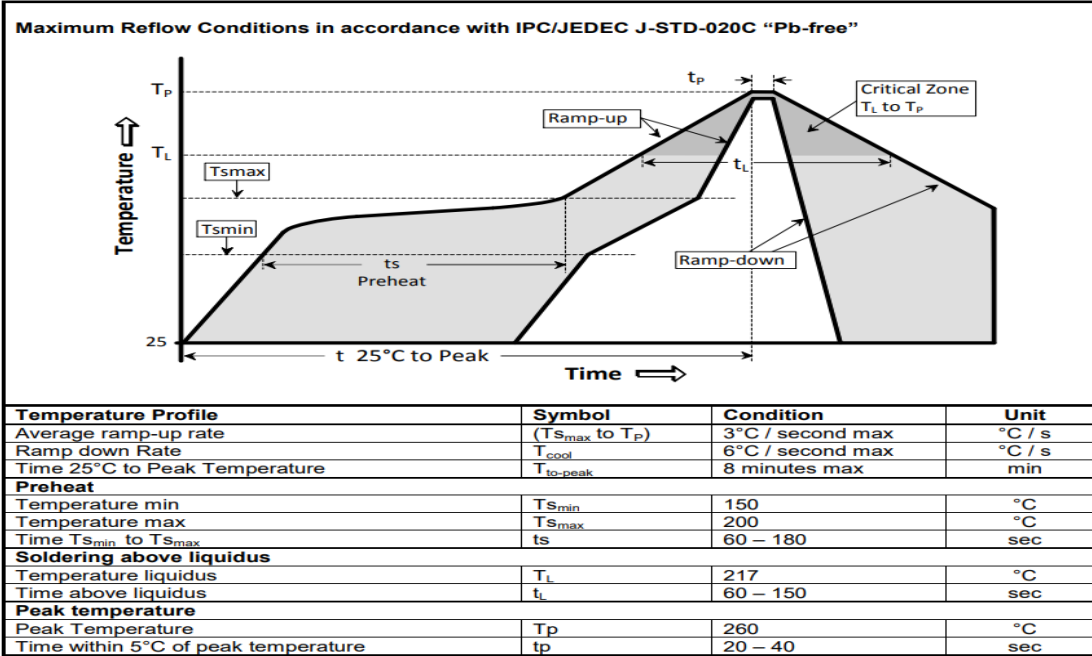

The part may be reflowed 2 times without degradation (typical for lead free processing).

## Tape and Reel

Tape and Reel available for quantities of 250 to 1000 per reel, cut tape for < 250. 12mm (or 16mm) tape, 8mm pitch.

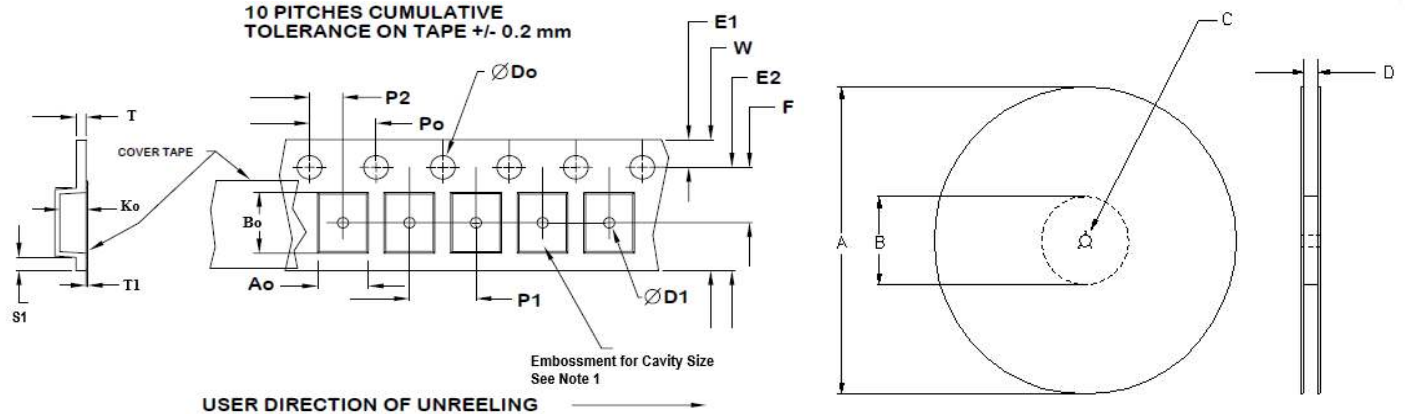

Tape Size	E2 typ	F	P1	W max	Ao	Bo	Ko
12mm	10.25	5.5 ±0.05	8.0 ±0.1	12.2	3.6±0.1	5.4±0.1	1.4±0.1
16mm	14.25	7.5 ±0.05	8.0 ±0.1	16.3	3.6±0.1	5.4±0.1	1.4±0.1

Reel Size	A		B		C	D
	Inches	mm	Inches	mm		
7	7.0	177.8	2.50	63.5	13.0 +0.5 -0.2	Tape size +0.4 +2.0 -0.0
10	10.0	254.0	4.00	101.6		
13	13.0	330.2	3.75	95.3		

Dimensions in mm Drawing Not to scale  
Note 1: Embossed cavity to conform to EIA-481-B

Tape Size	Do	D1 min	E1	Po	P2	S1 min	T max	T1 max
12mm	1.5	1.5	1.75	4.0	2.0	0.6	0.3	0.1
16mm	+0.1 -0.0	1.5	±0.1	±0.1	±0.05 2.0 ±0.1			



# PLETRONICS *PRONTO*<sup>™</sup> QM55L Series CMOS Configurable Clock Oscillator

## Important Notice

Pletronics Incorporated (PLE) reserves the right to make corrections, improvements, modifications and other changes to this product at anytime. PLE reserves the right to discontinue any product or service without notice. Customers are responsible for obtaining the latest relevant information before placing orders and should verify that such information is current and complete. All products are sold subject to PLE's terms and conditions of sale supplied at the time of order acknowledgment.

PLE warrants performance of this product to the specifications applicable at the time of sale in accordance with PLE's limited warranty. Testing and other quality control techniques are used to the extent PLE deems necessary to support this warranty. Except where mandated by specific contractual documents, testing of all parameters of each product is not necessarily performed.

PLE assumes no liability for application assistance or customer product design. Customers are responsible for their products and applications using PLE components. To minimize the risks associated with the customer products and applications, customers should provide adequate design and operating safeguards.

PLE products are not designed, intended, authorized or warranted to be suitable for use in life support applications, weapons, weapon systems or space applications, devices or systems or other critical applications that may involve potential risks of death, personal injury or severe property or environmental damage. Inclusion of PLE products in such applications is understood to be fully at the risk of the customer. Use of PLE products in such applications requires the written approval of an appropriate PLE officer. Questions concerning potential risk applications should be directed to PLE.

PLE does not warrant or represent that any license, either express or implied, is granted under any PLE patent right, copyright, artwork or other intellectual property right relating to any combination, machine or process which PLE product or services are used. Information published by PLE regarding third-party products or services does not constitute a license from PLE to use such products or services or a warranty or endorsement thereof. Use of such information may require a license from a third party under the patents or other intellectual property of the third party, or a license from PLE under the patents or other intellectual property of PLE.

Reproduction of information in PLE data sheets or web site is permissible only if the reproduction is without alteration and is accompanied by associated warranties, conditions, limitations and notices. Reproduction of this information with alteration is an unfair and deceptive business practice. PLE is not responsible or liable for such altered documents.

Resale of PLE products or services with statements different from or beyond the parameters stated by PLE for that product or service voids all express and implied warranties for the associated PLE product or service and is an unfair or deceptive business practice. PLE is not responsible for any such statements.

### Contacting Pletronics Inc.

Pletronics, Inc.  
19013 36th Ave. West  
Lynnwood, WA 98036-5761  
U.S.A.

Tel: 425.776.1880  
Fax: 425.776.2760  
email: ple-sales@pletronics.com

URL: [www.pletronics.com](http://www.pletronics.com)