

REAR VIEW

UNIT SHIPPED UNASSEMBLED.

OUTER BRACKETS FOR MOUNTING IN STANDARD 19" WIDE CABINETS.

OPTIONAL SELF-ADHESIVE RUBBER FEET (SUPPLIED)

LOAD RATING: 25 LBS. MAX.

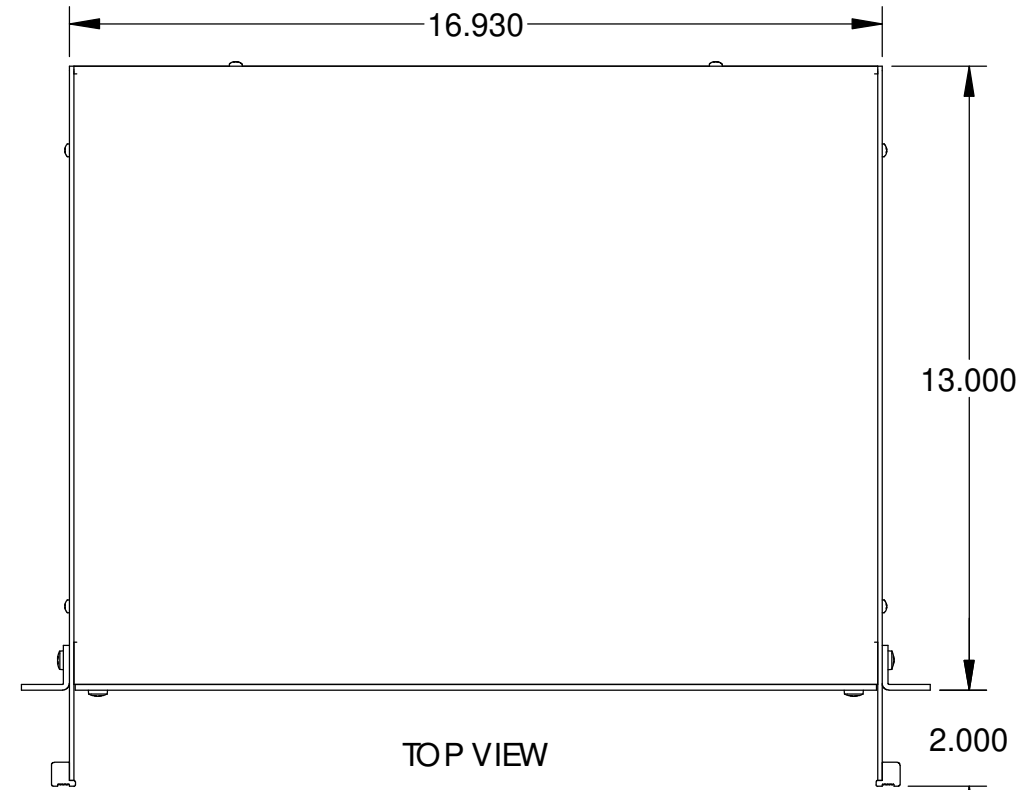

TOP VIEW

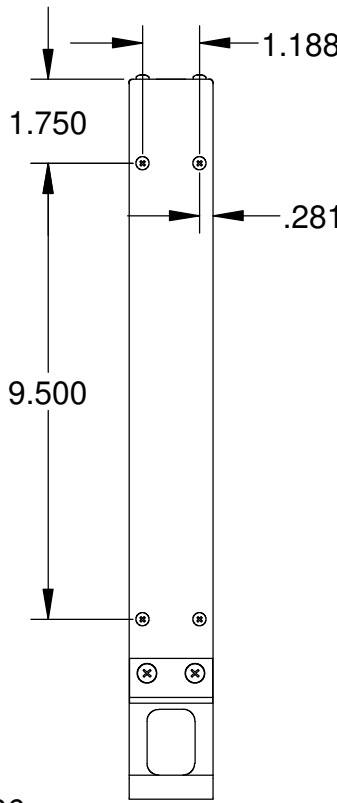

SIDE VIEW

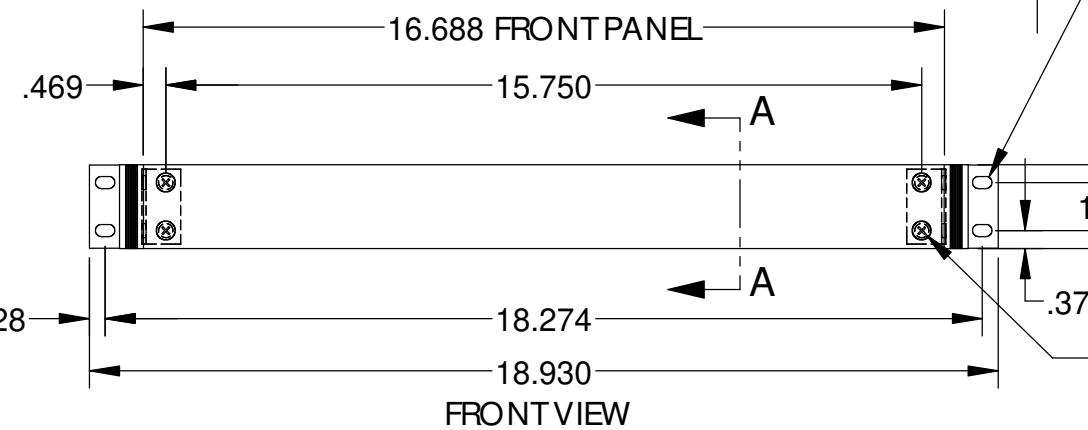
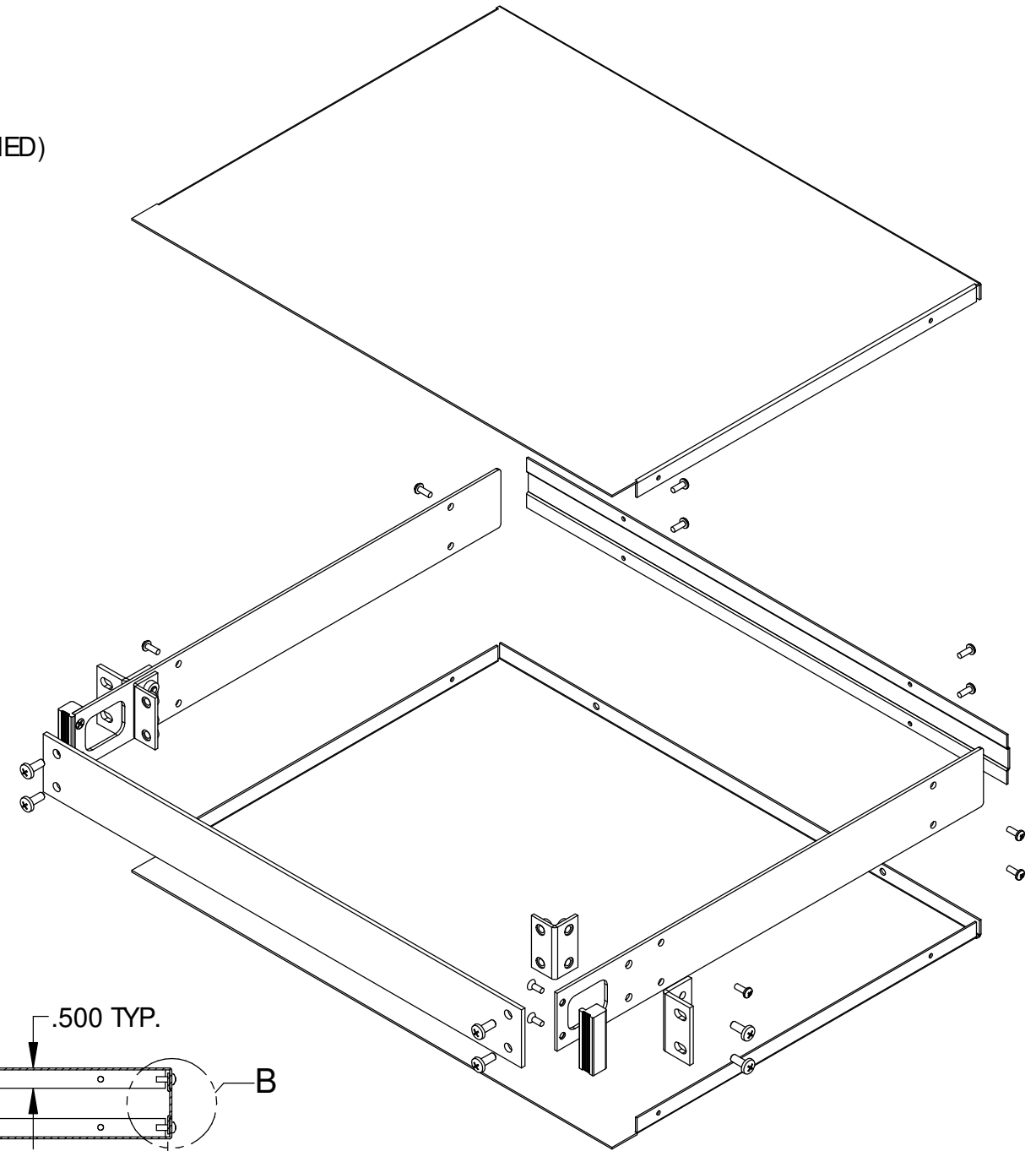

FRONT VIEW

Ø .250 x .406
OBROUND
(4) PLACES

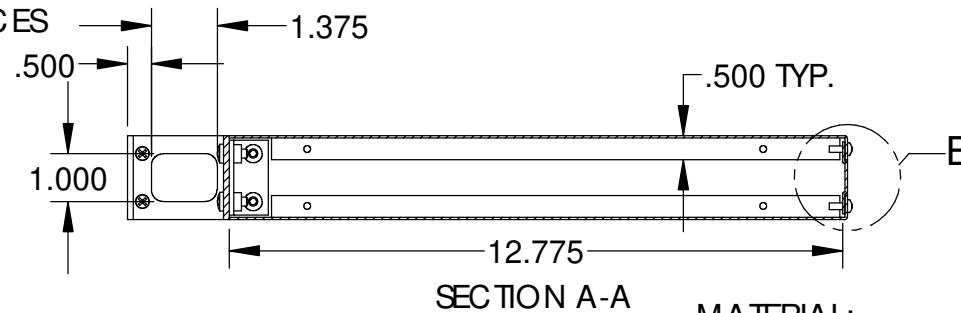

SECTION A-A

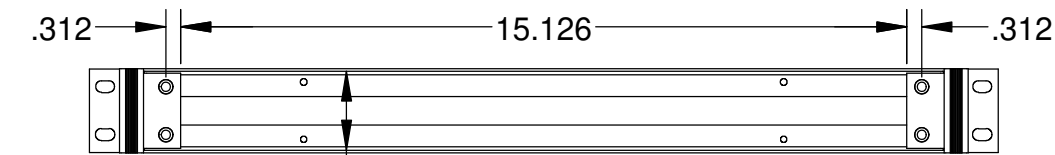

FRONT VIEW
(LESS FRONT PANEL)

1.650 BETWEEN COVERS

Ø .250 HOLE
IN FRONT PANEL
(4) PLACES

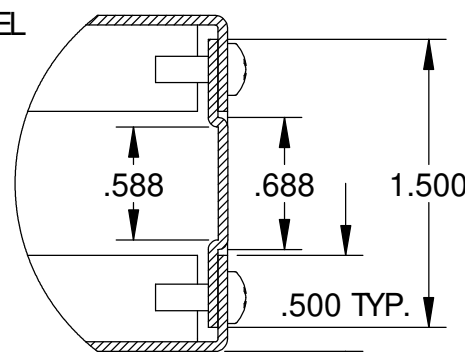

DETAIL B
SCALE 4 : 1

MATERIAL:

BACK & COVERS	0.050 THICK ALUMINUM
SIDES & INNER BRACKETS	0.090 THICK ALUMINUM
FRONT PANEL	0.125 THICK ALUMINUM
OUTER BRACKETS	11 GA. C.R.S.
HANDLE EXTRUSIONS	ALUMINUM

FINISH:

BACK & COVERS	PREPAINTED SMOOTH WHITE
SIDES & OUTER BRACKETS	WHITE TEXTURED
FRONT PANEL	NATURAL (OUTSIDE SURFACE TAPED WITH PVC)
INNER BRACKETS	NATURAL
HANDLE EXTRUSIONS	CAUSTIC ETCH & CLEAR ANODIZED
FEET	BLACK