

Stingray Robot (#28980)

The Stingray robot from Parallax Inc. provides a mid-size platform for a wide range of robotics projects and experiments. The Propeller Robot Control Board is the brains of the system providing a multiprocessor control system capable of performing multiple tasks at the same time. The Propeller chip provides eight 32-bit processors each with two counters, its own 2 KB local memory and 32 KB shared memory. This makes the Propeller a perfect choice for advanced robotics and the Stingray robot.

Features

- Multicore Propeller chip based control board
- Extra large EEPROM (64 KB) for storing additional data
- On-board 3.3 V & 5V switching power supply
- 5 V I/O translators to simplify interfacing to 5 V sensors/devices
- Integrated dual full bridge driver
- Two DC spur gear motors
- Two-wheel differential drive system with rear omnidirectional wheel
- Multiple mounting locations for sensors, add-ons, etc.
- Free online Propeller Tool programming software for Windows and example Stingray source code (requires Win2K/XP/Vista, IE7 or higher, and USB port)

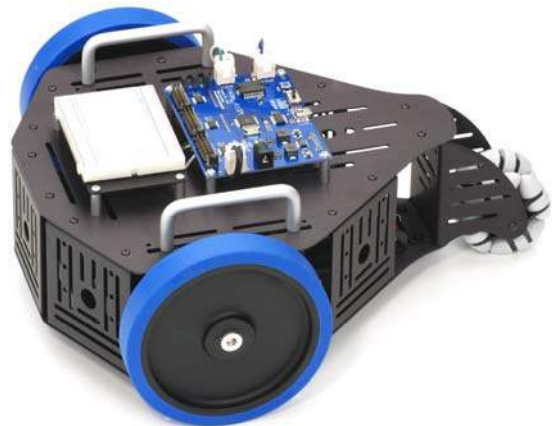

Key Specifications

- Power requirements: 6 AA 1.2 V Rechargeable Batteries (not included)
- Communication: USB A to Mini B Cable (included)
- Operating temperature: 32 to 158 °F (0 to 70 °C)
- Dimensions, assembled: 13" L x 10.9" W x 5.5" H (33 x 27.7 x 14 cm)

Prerequisites

This document covers assembly of your Stingray robot and testing of its motors. The Stingray is intended for those with previous programming and electronics experience, specifically prior experience with the Propeller chip microcontroller. The following resources are recommended for Propeller beginners:

- Propeller Education Kit Labs: This educational text is a great way to get started with the Propeller. It focuses on general Propeller programming and interfacing. The complete PDF and source code are included in the Propeller Tool v1.2.6 or later Help file.
- The Propeller Manual and Propeller Datasheet: These invaluable reference materials are also included in the Propeller Tool v1.2.6 or later Help file.
- The Propeller chip Forum (www.forums.parallax.com) At the top of the Propeller forum there is a sticky thread titled "Propeller: Getting Started and Key Thread Index." This link contains a wealth of information from Parallax and other sources for getting started with the Propeller.

Bill of Materials

This table contains a complete list of the parts used in this kit at the time this document was created. Parts and quantities are subject to change without notice. If you have any questions about your kit contents, please contact Parallax through the Tech Support Resources listed on page 26.

Part #	Description	Quantity
28230	Propeller Robot Control Board	1
27950	Motor, 7.2VDC, 310 RPM, 6mm Shaft	2
130-32000	PE Kit Project Parts	1
452-00060	Battery Retention Clip, 6 AA	1
500-00001	Transistor, NPN, Switching, 200 mA	4
700-00028	Screw, Zinc, Pan Head, Phillips, #4-40, 1/4"	16
700-00064	Parallax Screwdriver	1
700-00077	Breadboard, 3.19" L x 1.65" W	1
700-00081	Breadboard, 30 Row X 2 Column	2
710-00017	Screw, Black, Button Socket Cap, #4-40, 1/4"	34
710-00018	Screw, Black, Button Socket Cap, M3, 6mm	6
710-00019	Screw, Black, Phillips Flat Head, #4-40, 1/4"	2
710-00020	Screw, Zinc, Pan Head, Phillips, #8-32, 3/8"	4
712-00004	Washer, Zinc, #6 ID, 3/8" OD	2
713-00001	Standoff, Aluminum, 1/4" W, Round, 5/8" L, #4-40	8
713-00017	Nut, Black Oxide, #4-40	2
721-00008	Wheel, 4-7/8" Diameter, Blue Tread	2
721-00009	Wheel Hub, Aluminum, 6 mm Shaft (includes o-ring and set screw)	2
725-00062	Hex Key, 1/16"	1
725-00068	Hex Key, 2 mm	1
730-00050	Stingray Chassis Plate	2
730-00051	Stingray Motor Mount Plate	2
730-00052	Stingray Sensor Mount Plate	5
730-00053	Stingray Tail Wheel Mount Plate	1
730-00054	Multi-Directional Tail Wheel (Omni-Wheel)	1
730-00055	Stingray Tail Wheel Axle	1
730-00056	Handle, Aluminum, 3" Length, #8-32 Screw	2
730-00057	Breadboard Mounting Plate	1
753-00003	Battery Holder, 6AA, 12" w/Connector	1
800-00037	Jumper Wire, F-M, 120mm, 10-Pack	1
800-28900	Wire, 2-Conductor (Green/White), 20AWG, 10"	1
800-28980	Wire, 2-Conductor (Blue/White), 20AWG, 10"	1
805-00006	USB A to Mini B Cable	1

Assembly Instructions

This section will guide you step-by-step as you assemble your Stingray robot. Each step will describe the parts and tools required and then the procedure to assemble them. Each step contains a CAD drawing as a visual aid to the instructions. Be sure to follow each step carefully.

Preparation

- ✓ Match the Bill of Materials against the parts in your kit to make sure all parts are present.
- ✓ Find a clean workspace on which to assemble your robot. You might want to put down some newspaper or cardboard so that the edges of the metal parts do not scratch the work surface.
- ✓ Organize tools and parts prior to starting the assembly and separate parts by type to make it easier to gather them during the assembly process.
- ✓ Throughout the assembly process, when tightening screws be sure to get them nice and snug but do not over-tighten them or you may strip the threads.

Additional Tools Required

Two hex keys and one Phillips/flathead screwdriver are provided. The following additional tools are required:

- Safety glasses
- Small pair of needle-nosed pliers
- O-ring pliers if you have them (these are optional, but make things easier)



Safety first! Taking basic safety precautions is absolutely necessary when building the Stingray. The assembly process includes steps where there is the potential for injury. For example, you will be installing an o-ring which could fly off at high velocity if not installed properly. These dangers are minimized by wearing safety glasses during assembly and using the right tools for the job.

Stingray Robot Assembly (exploded view of major parts)

Note: The metal parts shown in the CAD drawings have been lightened to show detail.

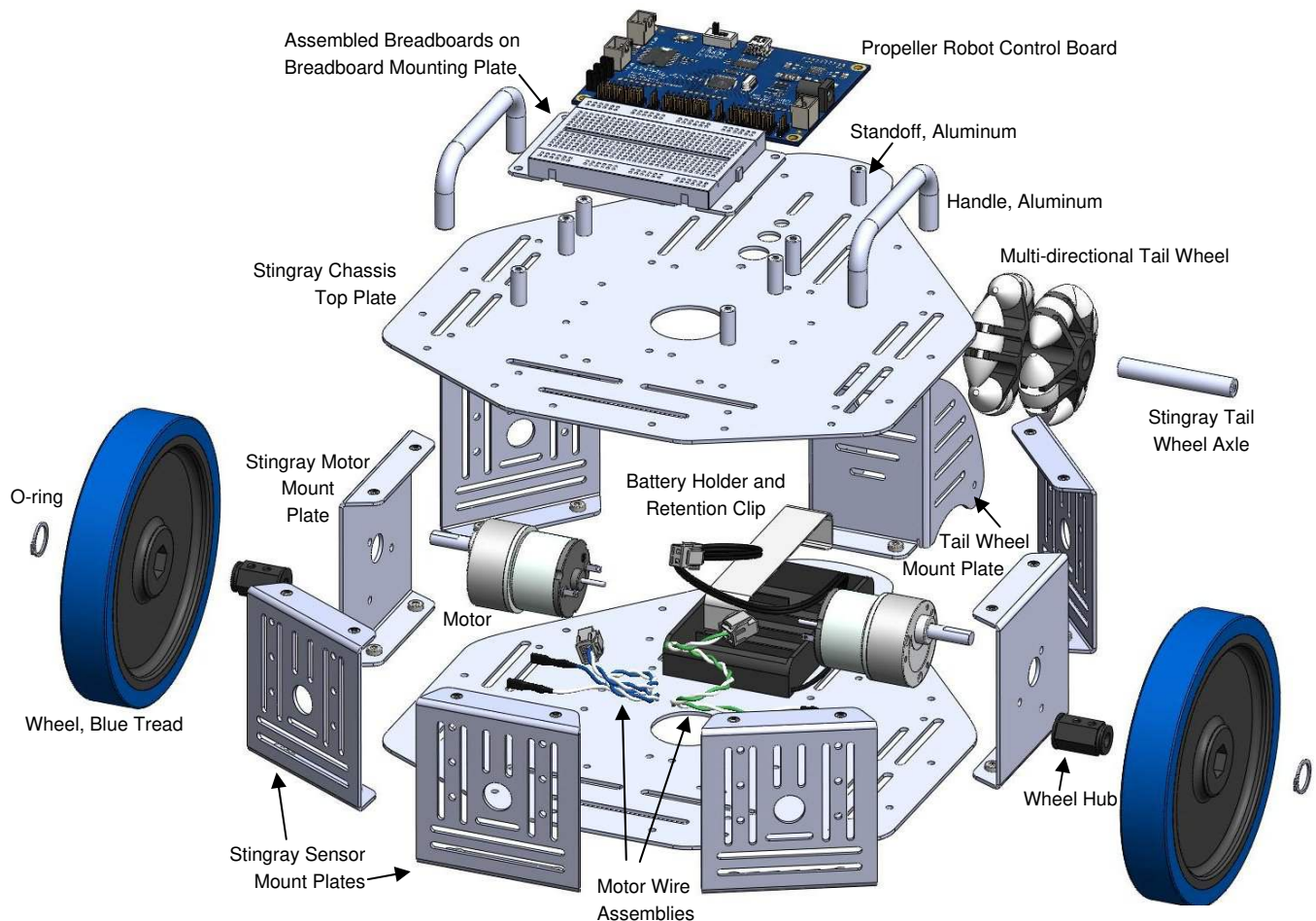

STEP 1: Chassis Assembly (lower)

Parts Required

- (1) Stingray Chassis Plate
- (5) Stingray Sensor Mount Plate
- (2) Stingray Motor Mount Plate
- (1) Stingray Tail Wheel Mount Plate
- (16) Screw, Black, Button Socket Cap, #4-40, 1/4"

Tools Required

- ✓ 1/16" Hex Key (included)
- ✓ Use the 1/16" Hex Key and the black #4-40 black button socket cap screws in this step. (Note that there are also 6 button socket cap screws and a 2 mm Hex Key; be careful to use the correct type.)
- ✓ Attach the Tail Wheel Mount Plate and Sensor Mount Plates to the Chassis Plate in the orientation shown below.
- ✓ Attach the Motor Mount Plates, being very careful to orient them correctly so that one screw hole is close to the Chassis Plate, which will be the bottom of the robot.

Tip: An easy way to do this step is to attach the Tail Wheel Mount Plate first, then attach the front Sensor Mount Plate. Now if you turn the Chassis Plate upside down each mount plate will slide right into position and should be easier to attach.

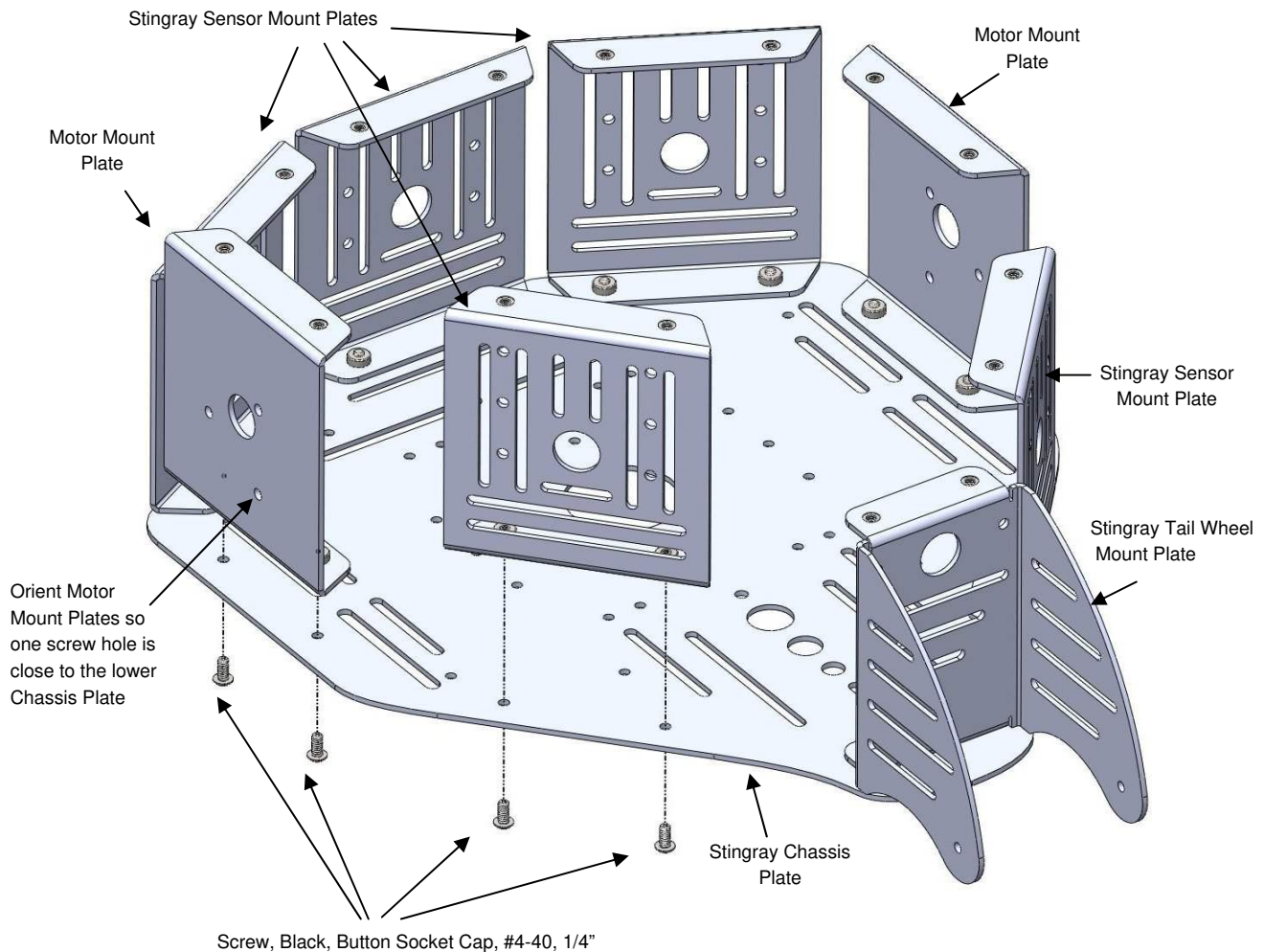

STEP 2: Motor Installation

Parts Required

- (2) Motor, 7.2 VDC, 310RPM, 6 mm Shaft
- (6) Screw, Black, Button Socket Cap, M3, 6 mm

Tools Required

- 2mm Hex Key (included)

- ✓ Using the included 2 mm Hex Key attach the motors to the Motor Mount Plates using 3 each of the M3 screws as shown in the figure below. The main body of the motors should be toward the bottom of the robot while the shaft should be toward the top.
- ✓ Be sure all three screws in each motor are very snug, but do not over-tighten.

Please note that the six M3 screws look very similar to the ones used on the chassis assembly in the previous step. To distinguish them from the others you can see that the hex hole in the head of the M3 is larger and uses the 2 mm (larger) Hex Key.

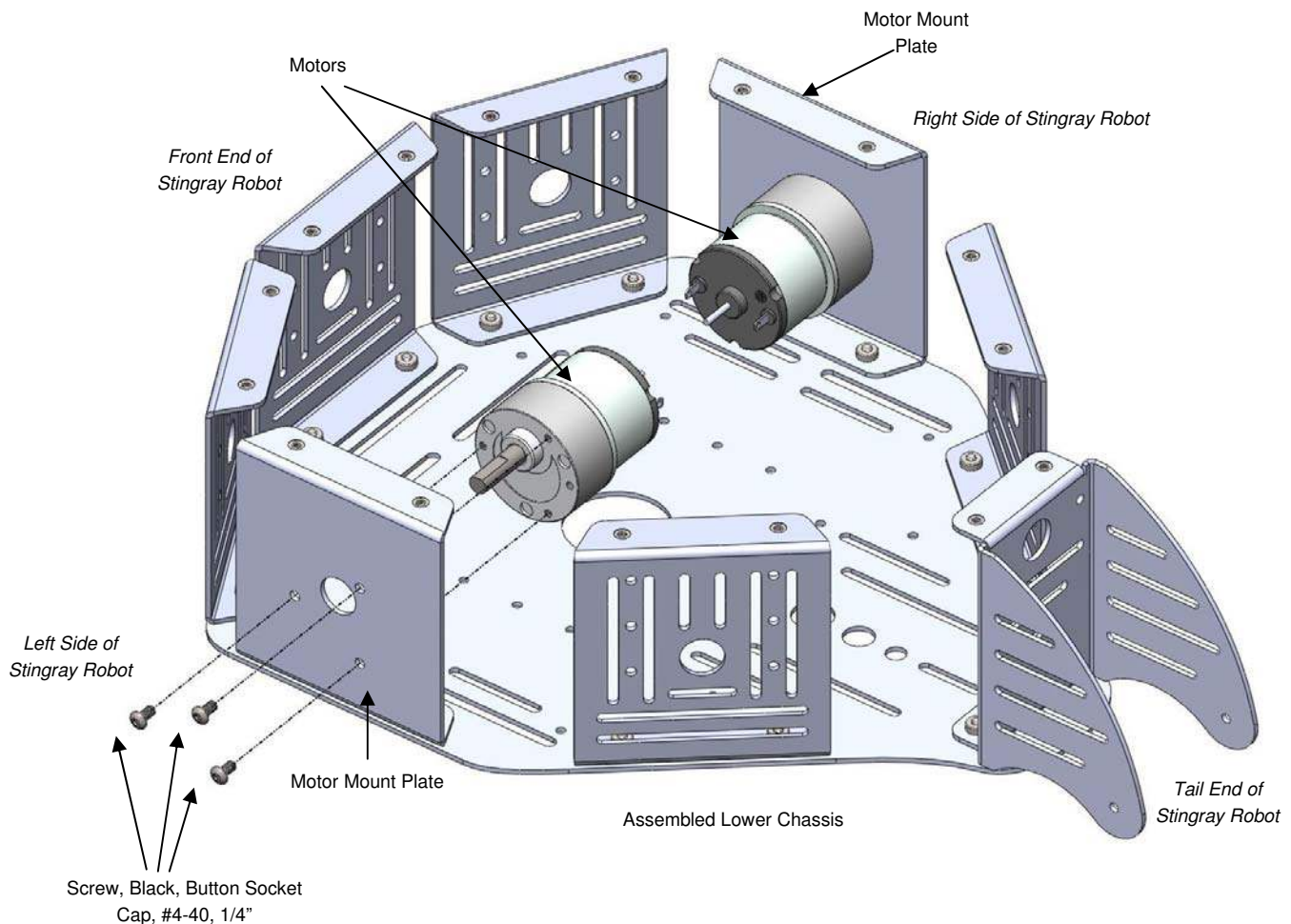

STEP 3: Motor Wire Connection

Parts Required

- (1) Wire, 2-Conductor (Green/White), 20AWG, 10"
- (1) Wire, 2-Conductor (Blue/White), 20AWG, 10"

Tools Required

- None

There are two Motor Wire Assemblies. One has a Green/White wire pair while the other has a Blue/White wire pair.

- ✓ Connect the Green/White Motor Wire Assembly to the *left* motor (shown) so that the green wire connects to the positive terminal and the white wire connects to the other terminal. See the figure below for details.
- ✓ Repeat the procedure for the *right* motor making sure to connect the blue wire to the positive terminal and the white wire to the other terminal.

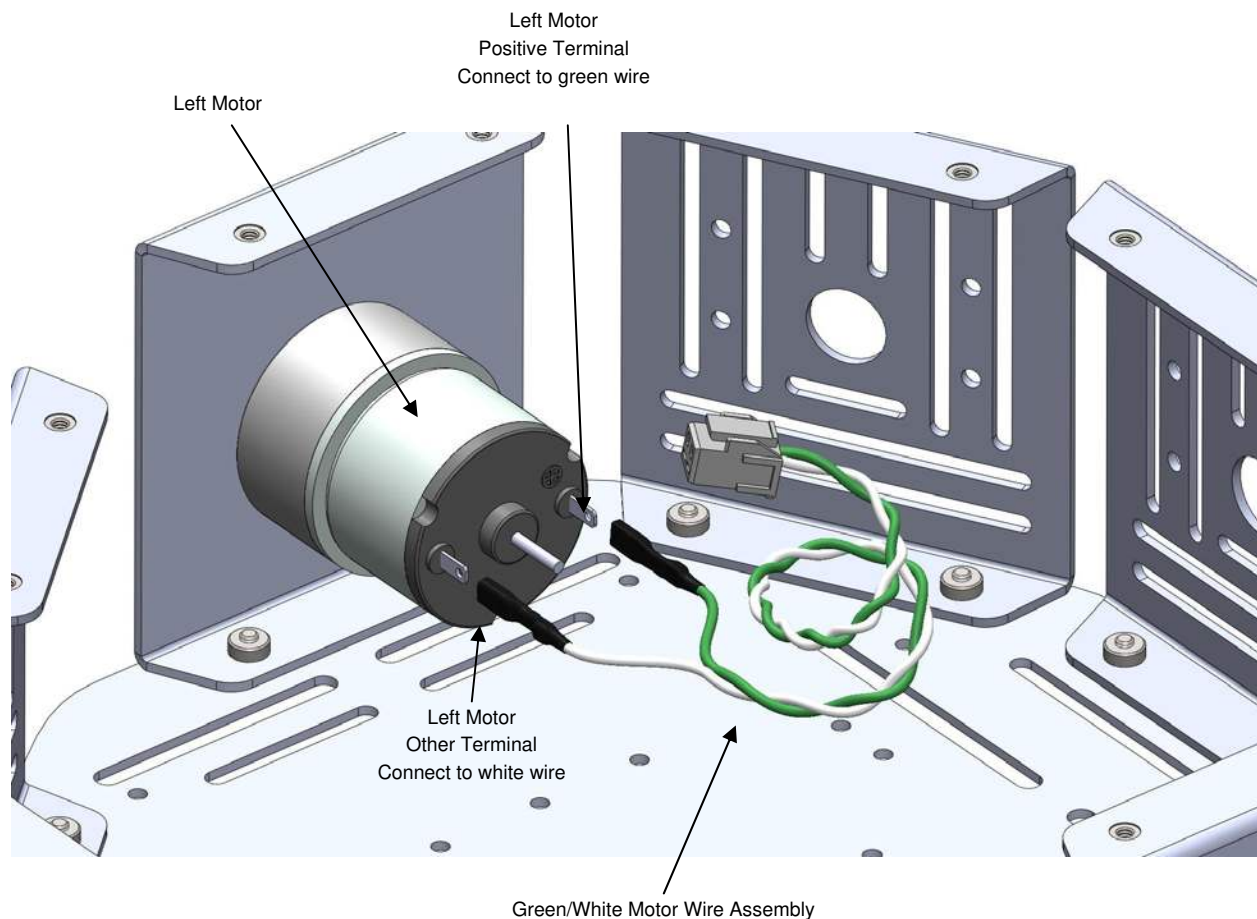

STEP 4: Hub Installation

Parts Required

- (1) Wheel Hub, Aluminum, 6mm Shaft
- (4) Hub Set Screws (included with hubs)

Tools Required

- 1/16" Hex Key (included)

- ✓ Using the included 1/16" Hex Key, install 2 set screws loosely into each Wheel Hub as shown in the figure below.
- ✓ Slide the hub onto the motor shaft so that the screws line up with the flat part of the motor shaft. The hub should slide all the way onto the shaft with just a small gap ($< 1/16"$) between the hub and the motor casing protruding through the motor mount plate.
- ✓ Both set screws should land on the flat part of the motor shaft when tightened down.
- ✓ Gently tighten the set screws. Be careful not to over-tighten the set screw but make sure it is very snug or the hub may work loose over time.
- ✓ Repeat this procedure for the other motor.

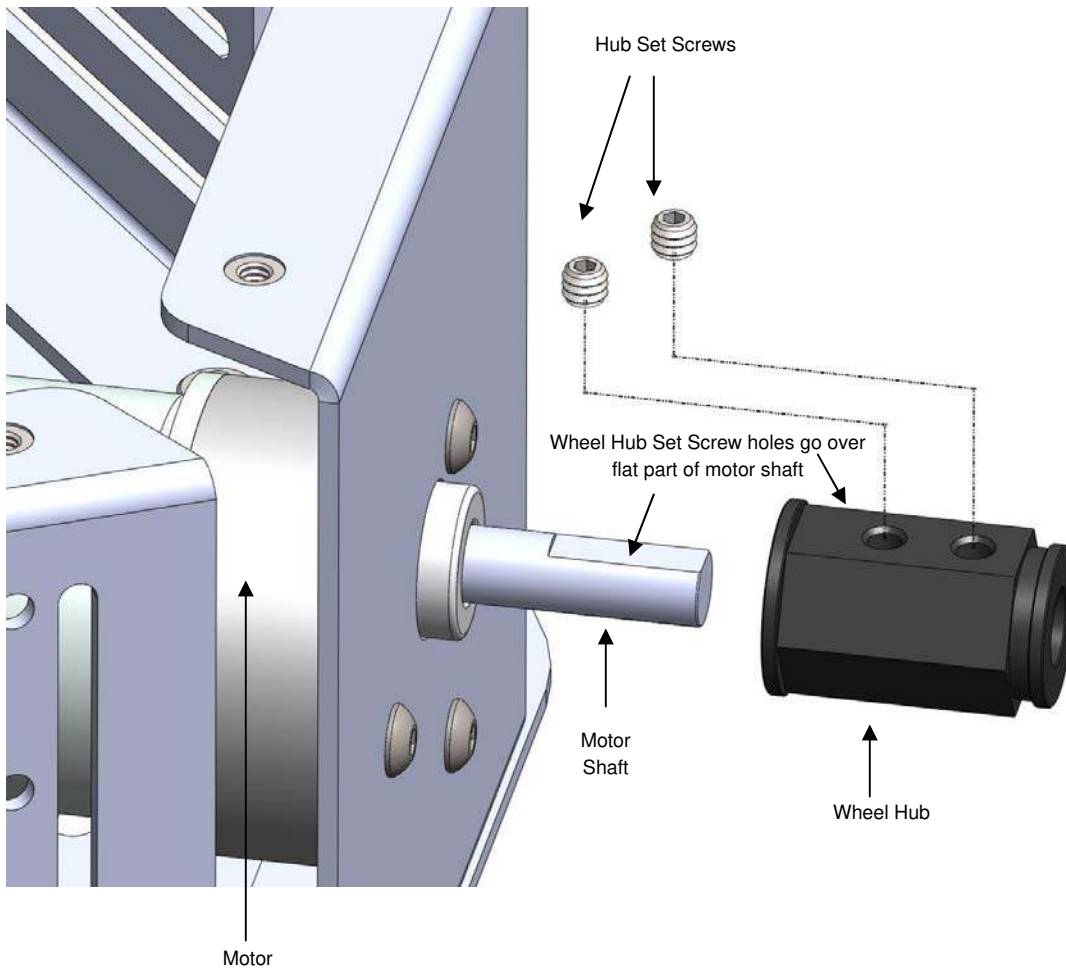

STEP 5: Front Wheel Installation

Parts Required

- (2) Wheel, 4-7/8" Diameter, Blue Tread
- (2) Hub o-ring (included with hubs)

Tools Required:

- Small pair of needle nosed pliers or snapping pliers (not included)
- Safety Glasses (not included)

- ✓ Be sure to wear your safety glasses during this step.
- ✓ Stand the robot on its side so that the hub and wheel are facing upward as shown in the first figure below. This will make it easier to install the o-ring onto the hub.
- ✓ Slide one of the wheels onto a hub. You can either hold the robot chassis between your legs or have someone else hold it in place for this step.
- ✓ To install the o-ring, place it over the hub and hold the back part of the ring in place as shown in the upper right figure.
- ✓ Using the o-ring pliers or small needle nosed pliers, separate the front of the o-ring while pressing down lightly. This should cause it to snap into place into the groove on the hub as shown in the lower right figure.
- ✓ Repeat with other wheel.

Note: A video clip demonstrating how to do install the Hub o-ring with needle nosed pliers is available for download on the Stingray robot product page on our website.

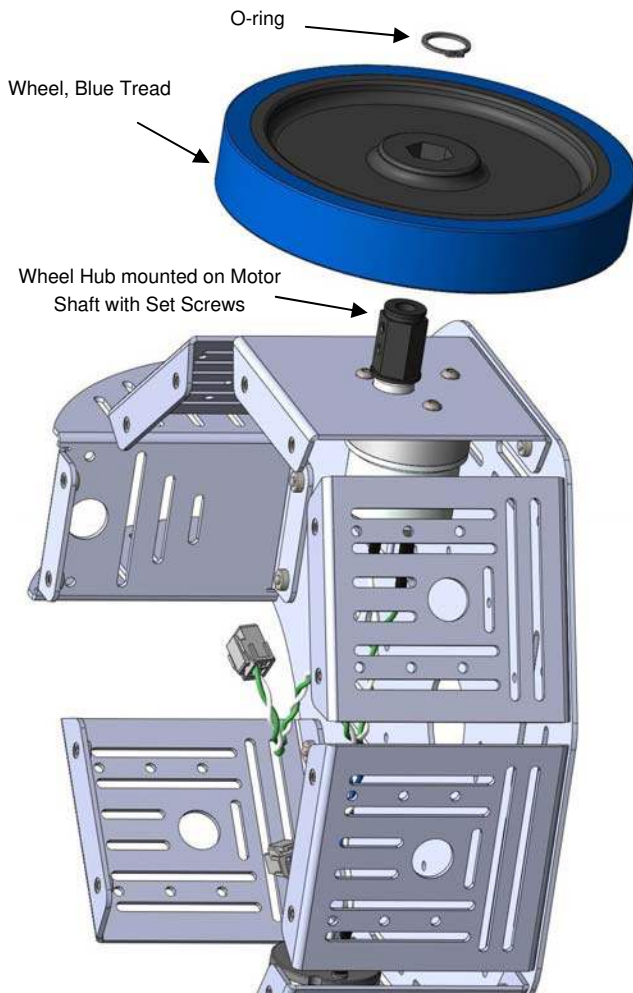

Place o-ring over the hub and hold the back part of the ring in place.

With pliers, separate the front of the o-ring while pressing down lightly.



When the O-ring snaps into place into the groove on the hub, release the pliers.



STEP 6: Tail Wheel Installation

Parts required

- (1) Multi-Directional Tail Wheel (Omni-Wheel)
- (1) Stingray Tail Wheel Axle
- (2) Screw, Black, Button Socket Cap, #4-40, 1/4"

Tools Required

- 1/16" Hex Key (included)

- ✓ Be sure the two halves of the Tail Wheel Assembly are joined.
- ✓ Slide the Tail Wheel Axle inside the Tail Wheel Assembly and place it between the fins of the Tail Wheel Mount Plate.
- ✓ Using the 1/16" Hex Key, insert the screws into each end of the axle as shown in the figure below.
- ✓ Be sure the axle screws are very snug or they may come loose over time.

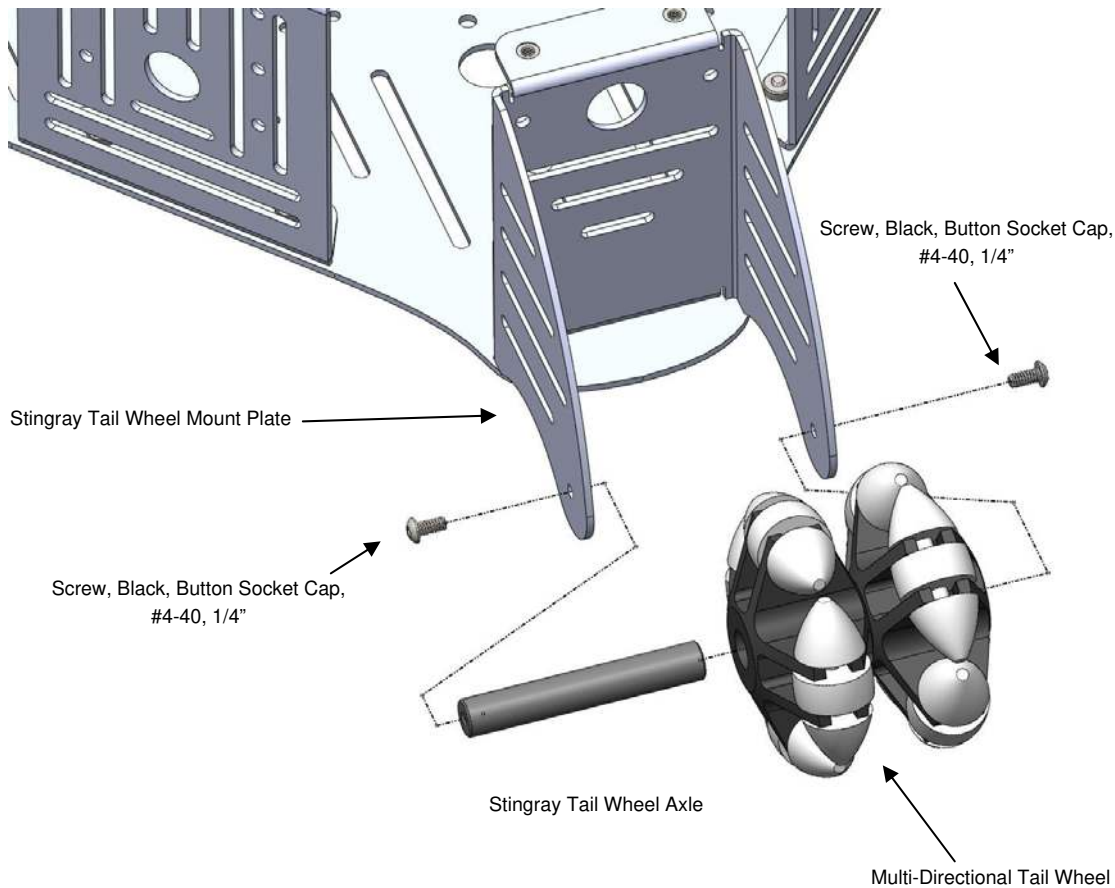

STEP 7: Battery Holder Installation

Parts Required

- (1) Battery Holder, 6AA, 12" w/Connector
- (2) Screw, Black, Phillips Flat Head, #4-40, 1/4"
- (2) Washer, Zinc, #6 ID, 3/8" OD
- (2) Nut, Black Oxide, #4-40

Tools Required

- Parallax Screwdriver (included)
- Small pair of needle nosed pliers (optional, not included)

- ✓ Place the Battery Holder into the chassis so that the wires are facing the left side of the robot.
- ✓ Study the figure below to see how the screws, washers and nuts are used to secure the Battery Holder in place:
 - The screws will go through the holes in the battery holder and then through the washers before passing through the chassis.
 - Nuts will thread onto screws from under the chassis. In this manner the washers will effectively raise the battery holder slightly from the chassis surface.
- ✓ Use the #1 Phillips screwdriver to snug the screws down. If the nuts turn while doing this you can use the needle nosed pliers to hold them.

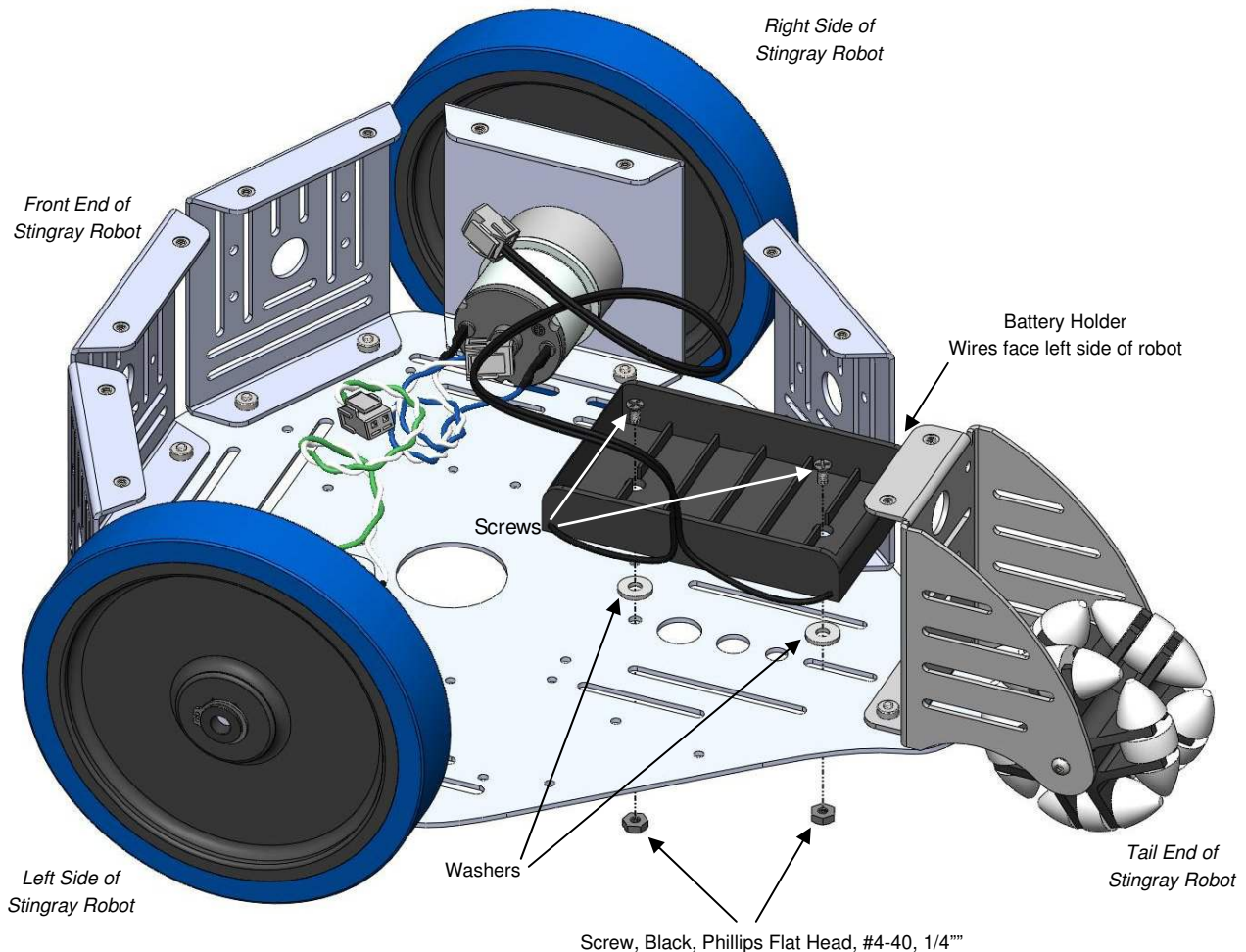

STEP 8: Battery Installation & Retention Clip

Parts Required

- (1) Battery Retention Clip, 6 AA
- 6 AA 1.2 V Rechargeable Batteries

Tools Required

- None

- ✓ Be very careful when handling the Battery Retention clip, as the thin metal could potentially cause a cut if you are not careful.
- ✓ Insert the 6 AA batteries into the holder being sure to observe polarity carefully. The negative side of each battery always faces the spring in each slot.
- ✓ Once all 6 batteries are installed, slide the retention clip from the side of the battery holder. The ends of the retention clip have tabs that, when properly installed, hook under the battery pack.

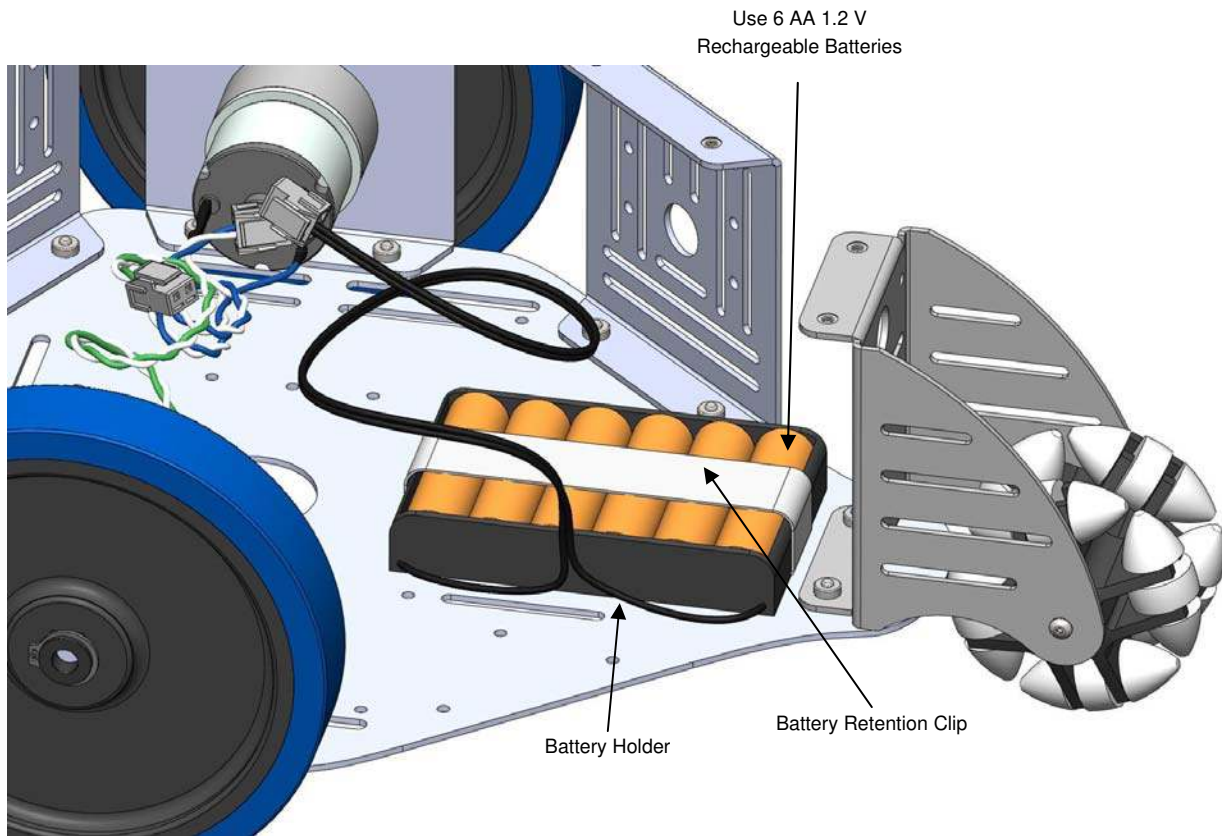

STEP 9: Chassis Assembly (upper)

Parts Required

- (1) Stingray Chassis Top Plate
- (2) Handle, Aluminum, 3" Length, #8-32 Screw
- (4) Screw, Zinc, Pan Head, Phillips, #8-32, 3/8"
- (8) Standoff, Aluminum, 1/4" W, Round, 5/8" L, #4-40
- (8) Screw, Zinc, Pan Head, Phillips, #4-40, 1/4"

Tools Required

- Parallax Screwdriver (included)
- 1/16" Hex Key (included)

- ✓ Position the Aluminum Handles over the Stingray Chassis Top Plate. The handles will only fit in the larger, outer slots on the left and right of the Chassis Plate.
- ✓ Using the Phillips end of the Parallax screwdriver, loosely attach the Aluminum Handles to the Chassis Plate using the #8-32 x 3/8" screws as shown in the figure below.
- ✓ Center each handle in the grooves and tighten the screws, careful not to over-tighten them.
- ✓ Using the Phillips end of the Parallax screwdriver, install the 8 standoffs into the holes shown below.

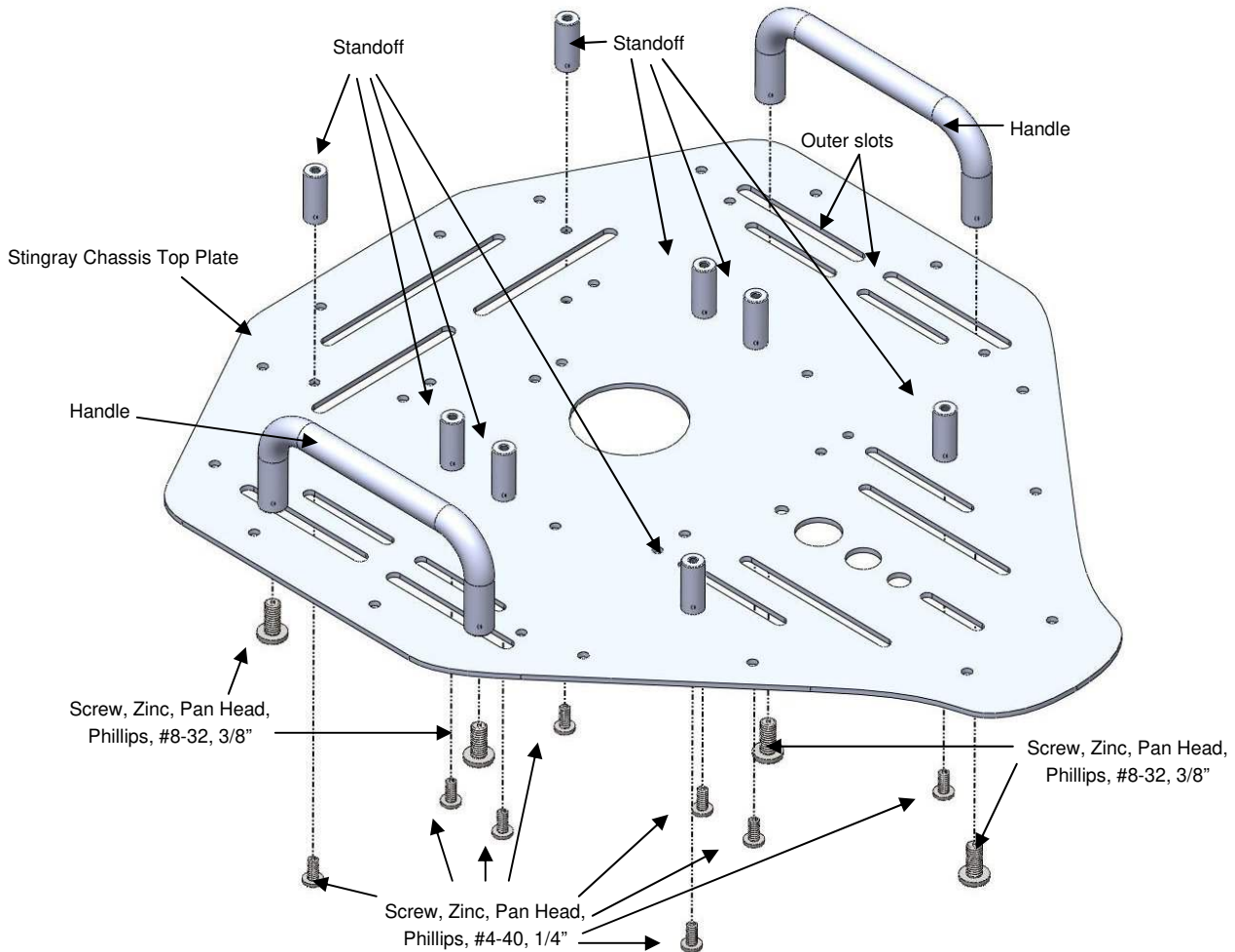

STEP 10: Attaching the Chassis Top Plate

Parts Required

- (16) Screw, Black, Button Socket Cap, #4-40, 1/4"

Tools Required

- 1/16" Hex Key (included)

- ✓ Place the Stingray Chassis Top Plate with the handles and standoffs installed over the robot.
- ✓ Bring the Motor Wires and Battery Holder Wire up through the large center hole as shown below.
- ✓ Line the Top Chassis Plate up with the holes in the Stingray Sensor Mount Plates.
- ✓ With the 1/16" Hex Key, attach the Chassis Plate using the 16 button socket cap #4-40 x 1/4" screws.

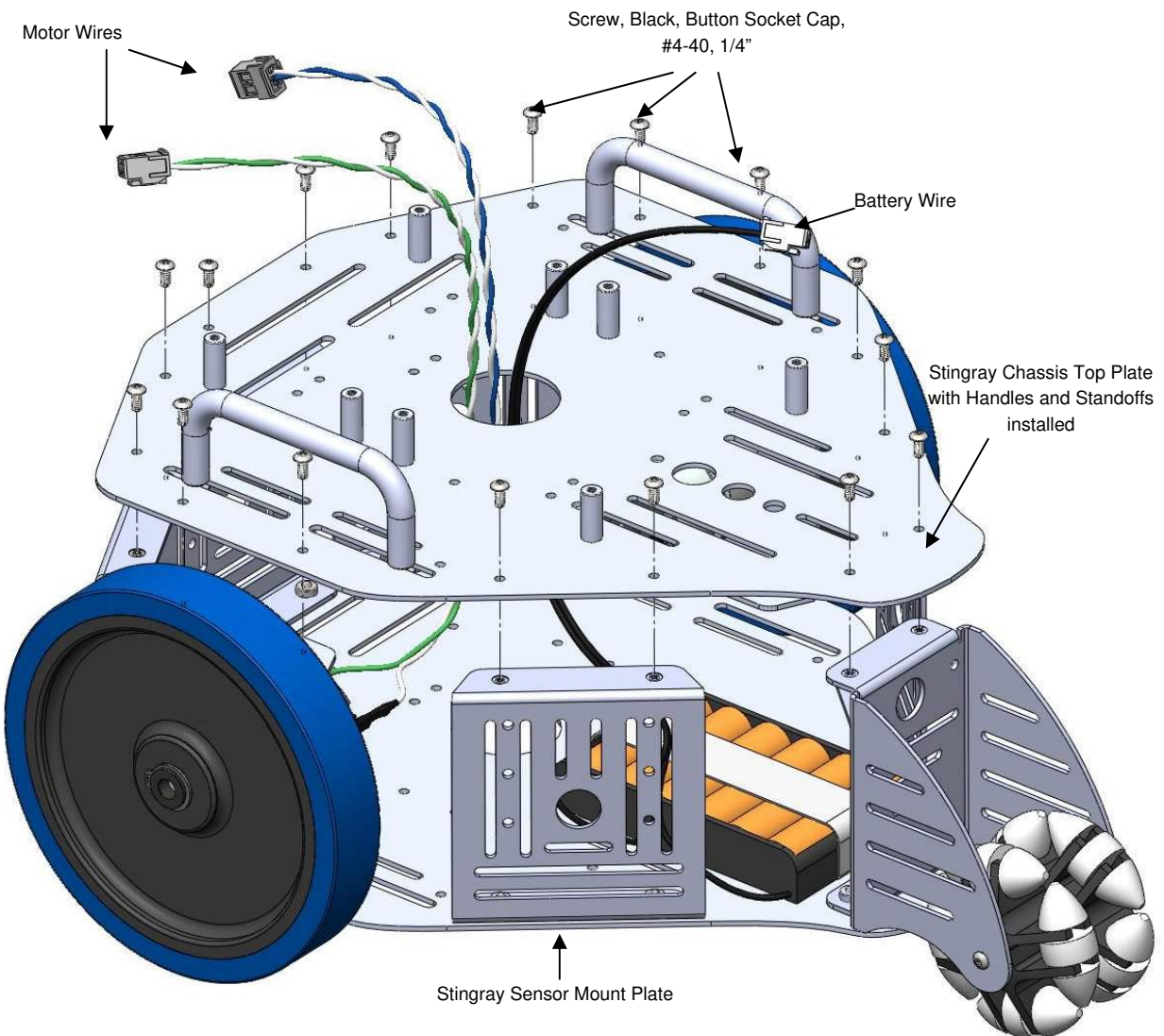

STEP 11: Breadboard Assembly

Parts Required

- (1) Breadboard, 3.19" L x 1.65" W
- (2) Breadboard, 30 Row X 2 Column
- (1) Breadboard Mounting Plate

Tools Required

- None

- ✓ Assemble the three breadboard sections so that they look like the figure below.
- ✓ Carefully remove the strip covering the adhesive backing on the Breadboard sections.
- ✓ Before adhering it to the Breadboard mounting Plate, align it carefully so you do not cover up the mounting holes, as you won't be able to remove and reposition it again.
- ✓ When you are sure of your alignment, stick the assembled breadboards to the Breadboard Mounting Plate as shown by the cross-hatch area in the figure below.

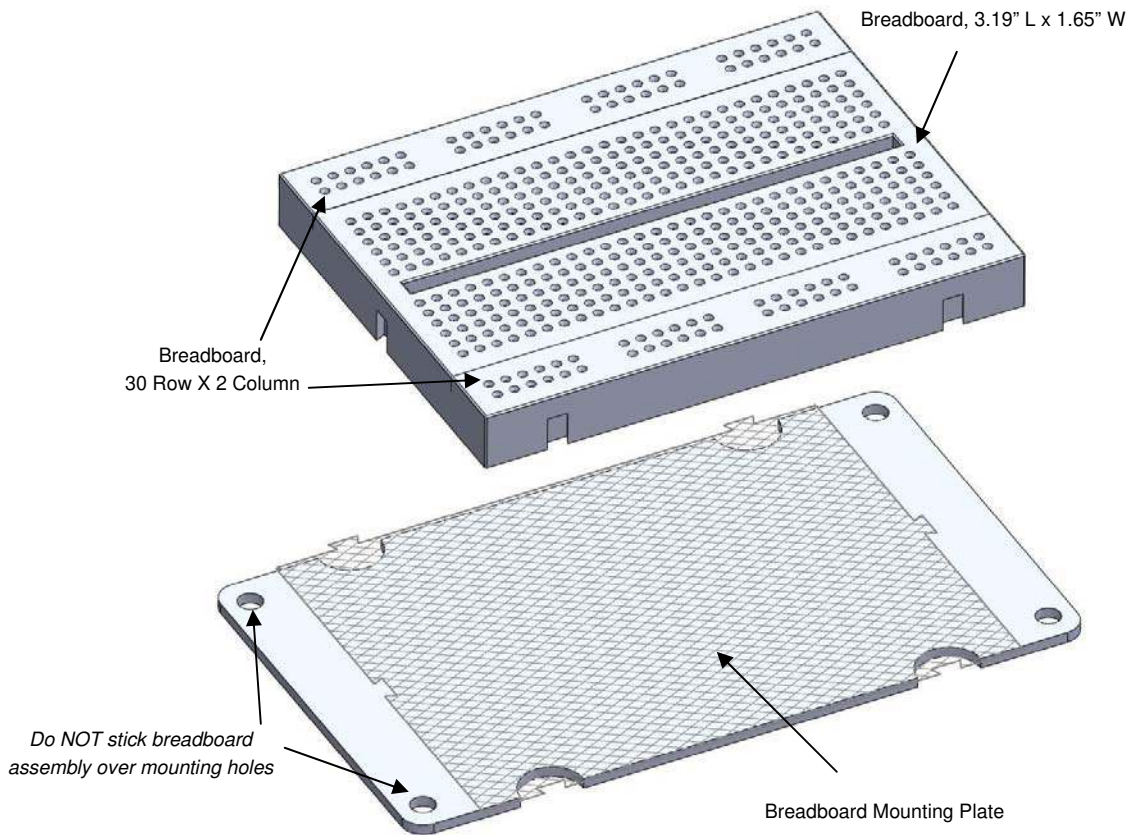

STEP 12: Installing the Breadboard and Control Board

Parts Required

- (1) Propeller Robot Control Board
- (1) Breadboard Assembly (from previous step)
- (8) Screw, Zinc, Pan Head, Phillips, #4-40, 1/4"

Tools Required

- Parallax Screwdriver (included)

- ✓ Using the Phillips end of the Parallax Screwdriver, attach the Breadboard Assembly to the standoffs closest to front end of the Stingray Robot using the #4-40 x 1/4" screws.
- ✓ Place the Propeller Robot Control Board on the remaining four standoffs, oriented so that the long row of 3-pin headers is closest to the breadboard assembly.
- ✓ Route the Battery Wire out from under the left side of the board, and the Motor Wires out from under the right side of the board as shown in the figure below.
- ✓ Using the Phillips end of the Parallax Screwdriver, attach the Propeller Robot Control Board to the standoffs using the #4-40 x 1/4" screws.

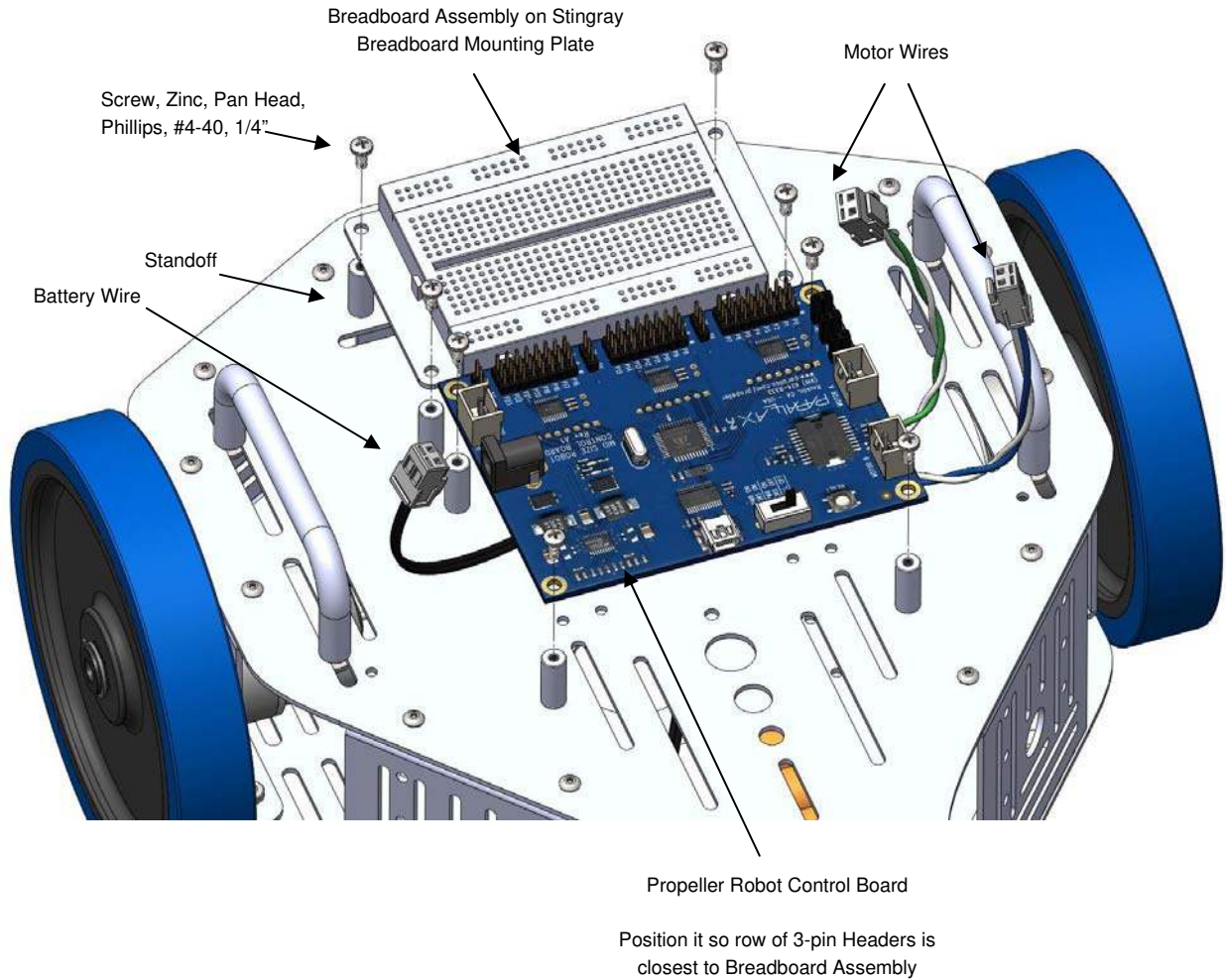

STEP 13: Connecting Battery and Motor Wires

Parts Required

- Assembled Stingray Robot

Tools Required

- None

- ✓ Insert the Battery Wire plug into the matching socket just in front of the DC Barrel Jack on the Propeller Robot Control Board as shown in the figure below.
- ✓ Insert the Green/White Motor Wire plug into the Motor A socket on the opposite side of the Propeller Robot Control Board as shown in the figure below.
- ✓ Insert the Blue/White Motor Wire plug into the Motor B socket.

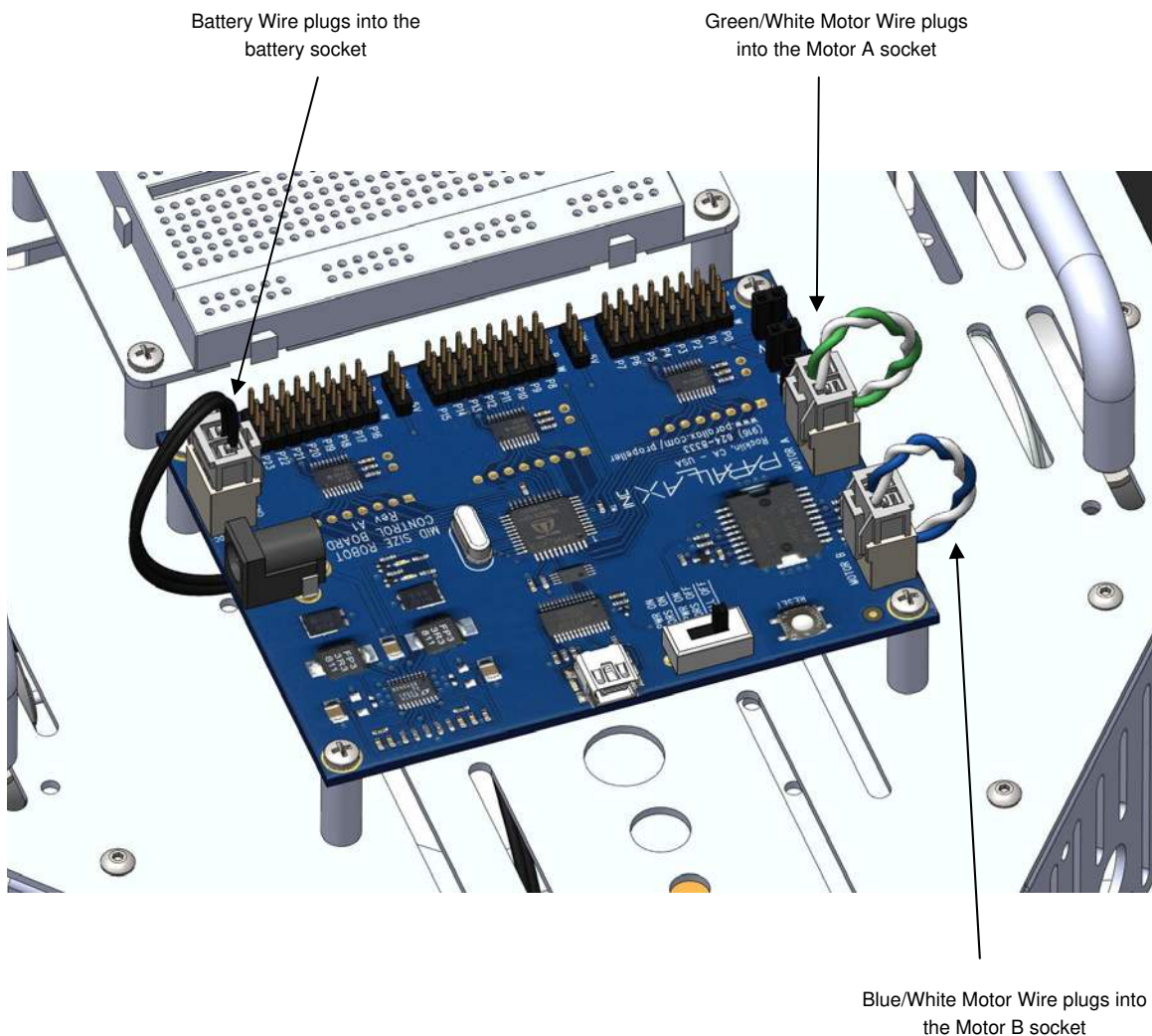

Completed Stingray Robot

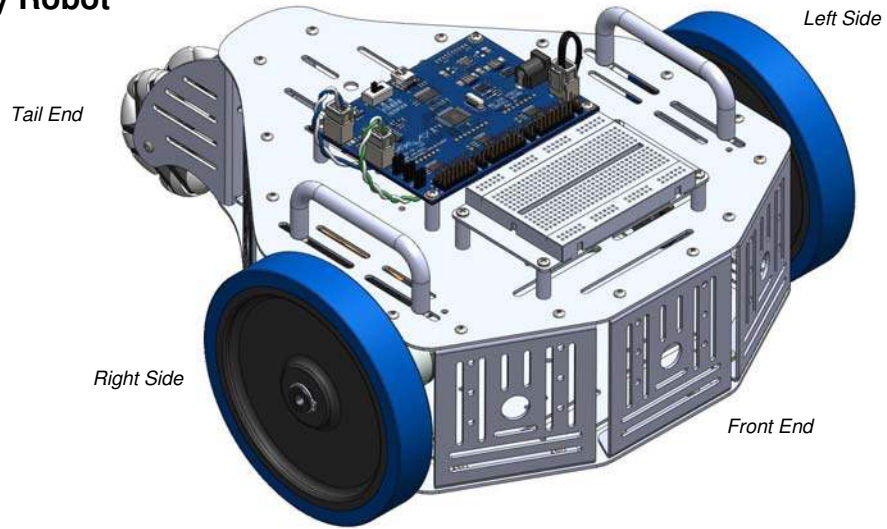

Propeller Robot Control Board

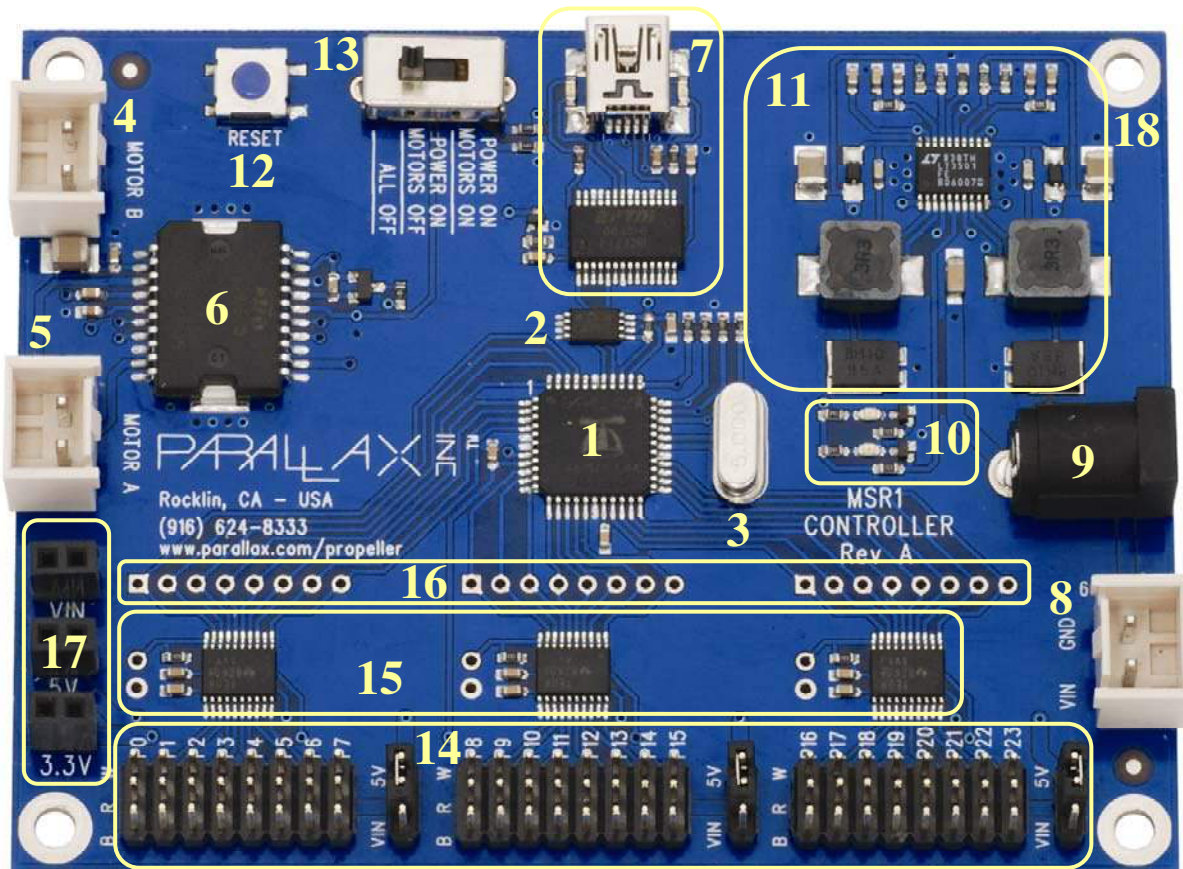

- | | | |
|---------------------------|---------------------------------|---------------------------------|
| 1. Propeller P8X32A-Q44 | 7. USB Connector | 13. 3-Position Power Switch |
| 2. 64 KB EEPROM | 8. Battery Pack Socket | 14. Headers to I/O P0-P23 |
| 3. Socketed 5 MHz Crystal | 9. Barrel Jack, 2.1 mm | 15. Voltage Translators for I/O |
| 4. Right Motor Socket | 10. Power Good/Fail LEDs | 16. Direct I/O Access Vias |
| 5. Left Motor Socket | 11. Dual Switching Power Supply | 17. VIN, 5V, 3.3V Headers |
| 6. L6205 H-Bridge Driver | 12. Reset Button | 18. Ground/Mounting Vias |

Control Board Details

The Propeller Robot Control Board provides all the necessary base circuits needed to build a very powerful mid-size robotics platform. The control board has an on-board USB serial interface to facilitate programming and communication with the Propeller chip. A dual switching supply provides 3.3 V and 5 V @ up to 3 A each. The on-board dual full bridge driver makes it possible to directly drive the Stingray's DC brushed gear motors with an extra motor controller. The 24 available I/O pins are buffered through three 8-bit bidirectional voltage level translators providing direct 5 V interface capability. Finally, the input voltage can come from the included battery pack, an aftermarket battery pack or a wall adapter using a standard 2.1 mm barrel plug. See below for details of the on-board hardware and connections.

Propeller P8X32A-Q44 [1]

The multicore Propeller chip contains 8 cogs (processors) that can operate simultaneously, both independently and cooperatively with other cogs, sharing access to global memory and the system clock in a round-robin fashion through a central hub. Each cog has access to all 32 I/O pins, with pin states tracked in its own I/O output and direction registers. Each cog also has its own memory, as well as two counter modules and a video generator. See the Propeller Manual and datasheet in the Propeller Tool Help for more information.

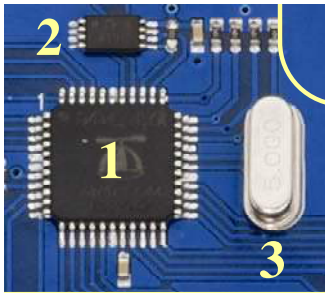

64KB EEPROM (P28 – P29) [2]

The AT24C512 EEPROM (see the figure at left) chosen for the Stingray is 64KB instead of 32KB, allowing for extra memory to store user data. This extra memory could be used for GPS lookup tables, map data or whatever you choose. This extra 32 KB is not overwritten when programming the EEPROM via the Propeller Tool software. This means that when you download a new program to the EEPROM the data in the upper 32K is not lost. The SCL line is connected to P28 and the SDA line is connected to P29.

Socketed Crystal [3]

A 5 MHz crystal is included in the socket next to the Propeller chip. With the included crystal the Propeller chip can run at 5, 10, 20, 40 and 80 MHz. By exchanging the crystal for one of a different value other operating frequencies can be achieved. Refer to the Propeller datasheet for more information about using external crystals.

L6205 Dual Full Bridge Driver (P24 – P27); Motor Sockets [4, 5, 6]

The L6205 driver is connected to the Propeller chip via I/O pins P24–P27. P24 and P25 control Motor A while P26 and P27 control Motor B.

The L6205 used on the Propeller Robot Control Board is a Dual Full Bridge Driver that offers many advantages in comparison to a simple H-Bridge circuit alone. As a dual driver it can handle two motors at up to 2.8 A (5.6 A peak) with an operating frequency of up to 100 kHz. The L6205 also provides non-dissipative over-current protection and thermal shutdown. Internal logic eliminates the possibility of an improper configuration of the driver that might cause a short circuit. Connections to the output of the H-Bridge are made through the Motor A and Motor B socket's connectors (Molex #0351560200).

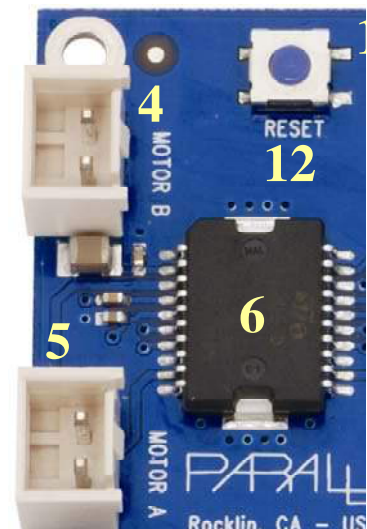

The L6205 inputs are connected to P24 through P27 on the Propeller chip. When the power switch on the control board is set for POWER ON/MOTORS ON, the L6205 is enabled and the outputs are connected to the motors. The truth table for controlling the L6205 is shown below in Table 1. P24 and P25 control the left motor while P26 and P27 control the right motor. This table assumes the motors are connected to the control board as defined in the assembly instructions.

Table 1: Motor Truth Table					
P24	P25	P26	P27	Left Motor	Right Motor
0	0	0	0	Brake	Brake
1	0	0	0	Reverse	Brake
0	1	0	0	Forward	Brake
1	1	0	0	Brake	Brake
0	0	1	0	Brake	Forward
1	0	1	0	Reverse	Forward
0	1	1	0	Forward	Forward
1	1	1	0	Brake	Forward
0	0	0	1	Brake	Reverse
1	0	0	1	Reverse	Reverse
0	1	0	1	Forward	Reverse
1	1	0	1	Brake	Reverse
0	0	1	1	Brake	Brake
1	0	1	1	Reverse	Brake
0	1	1	1	Forward	Brake
1	1	1	1	Brake	Brake

Note that it may be more intuitive to look at the table as two groups consisting of P24/P25 and P26/P27. In this manner you have 4 possible combinations for each motor as shown in Table 2.

Table 2					
P24	P25	Left Motor	P26	P27	Right Motor
0	0	Brake	0	0	Brake
1	0	Reverse	1	0	Forward
0	1	Forward	0	1	Reverse
1	1	Brake	1	1	Brake

Pulse-width modulating one of the inputs in the opposite state of the other pin will cause that motor to move at a speed proportional to the duty cycle of the signal. A wide range of frequencies could be used for pulse-width modulating DC brushed motors.

The USB Serial Interface (P30 – P31)

The USB interface (see the figure at right) provides a serial connection to the Propeller chip through the USB port of your PC. This interface is used for both programming and communication with the control board and is based on the FTDI FT232RL. A green LED indicates data coming into the control board and a red LED indicates data being sent to the PC. Data coming into the control board goes to P31 on the Propeller chip while data being sent comes from P30.

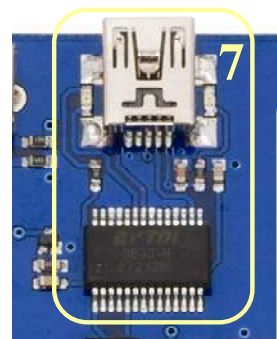

Battery Pack Socket [8] and Barrel Jack Connector [9]

The Battery Pack Socket accepts the connector on the Stingray Battery Pack. The Barrel Jack Connector is for use with a 6-15 VDC wall-mount power supply, with a center positive 2.1 mm barrel connector. NOTE: Using the Barrel Jack Connector temporarily disables the Battery Pack Socket.

CAUTION: The input voltage (VIN) is also the motor voltage. For this reason you should not use a wall adapter or battery higher than 7.5 VDC when enabling the motors (power switch moved to the third (right) position, see below). Voltages higher than 7.5 VDC can severely reduce the life of the motors and potentially damage them.

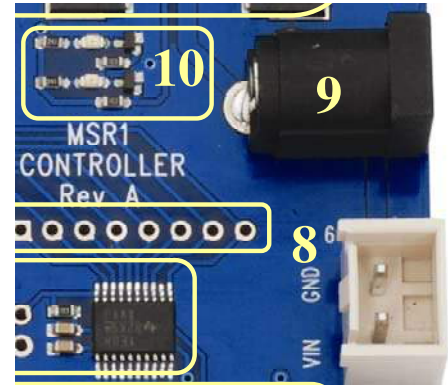

Power Good/Fail Indicator LEDs [10]

There are actually two LEDs for power indication on the control board, one red and one green (see the figure above). The green LED means the power is good. If the input voltage falls below approximately 6 VDC the green LED goes out and the red LED above it comes on. You may also notice when switching the power on/off that the red LED briefly blinks while the power supply rails stabilize.

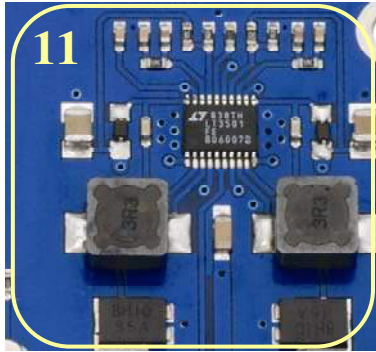

LT3501-based Dual Switching Supply [11]

The power supply uses the LT3501 Dual Tracking 3 A Switching Regulator to provide the 3.3 V and 5 V used on the control board. This supply regulates the 6 – 15 VDC on the input down to the desired voltages at up to 3 A of current per supply.

Reset Button [12]

This button resets the Propeller chip, initiating its boot up procedure (see the Propeller Help). Be aware that if the motors are running, this will cause them to go into brake mode (see Table 1 on page 19).

3-position Power Switch [13]

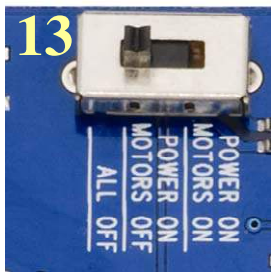

The first (left) position, marked ALL OFF, turns off power to the Control Board, I/O headers when set to 5 V, and motors. In this position the power LED is out. The second (middle) position, marked POWER ON / MOTORS OFF, turns on power to the control board and I/O headers, but disables the H-Bridge, effectively turning the motors off. The last (right) position on the power switch, marked POWER ON / MOTORS ON, turns on power to the control board, I/O headers and motors. Note that the 3-position switch has no effect on VIN availability at the I/O headers set to VIN, nor at the VIN power supply tap (see VIN, 5 V, and 3.3 V Power Access Headers [17] on page 21).

Headers to 24 Available I/O Pins (P0 – P23) [14]; Voltage Translators [15]

The 24 available I/O pins are connected to three TXB0108 8-bit bidirectional voltage level translators that convert the voltage from 3.3 V at the Propeller chip to 5 V at the I/O headers and provides some short circuit protection with built-in 4 kΩ resistors. These fully bidirectional pins are grouped as three ports with eight I/O lines each: P0–P7, P8–P15 and P16–P23.

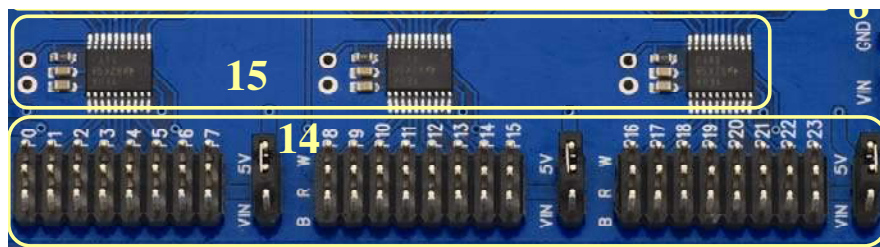

Each group is brought out to I/O headers. These pins are labeled W, R and B, referring to the typical colors of a servo extension cable. W (white) is the signal pin, R (red) is the power pin and B (black) is the ground connection for each port.

To the right of each group of I/O headers is a jumper that allows either 5 V or VIN to be available at the center (power) pin of that group. By default this is set to 5 V for all three groups. NOTE: When the jumper is in the VIN position the I/O headers will have power at the R row regardless of the position of the power switch.

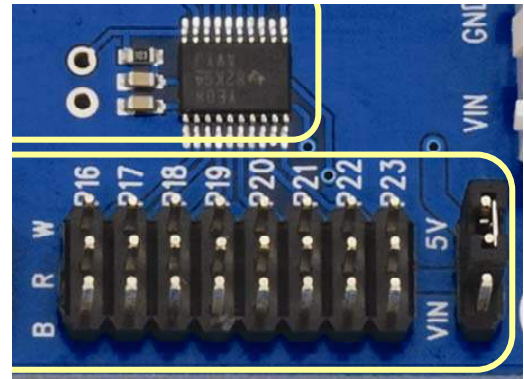

All data at the I/O header signal (W) pins is at 5 V signal levels, however if you should need direct access to the Propeller chip I/O for 3.3 V interfacing, it is possible to disable a translator and gain direct access to the eight I/O pins connected to it. Doing this requires the addition of some headers which would need to be soldered to the control board. The following section describes how to complete this procedure.

NOTE: While a translator has been disabled, all eight I/O pins in that group are affected and cannot be accessed from the I/O header pins.

Direct I/O Access Vias [16]

In the figures below, the control board has had headers soldered into the unpopulated pads above and to the left of the center translator IC. This will allow you to connect pluggable wires to P8 through P15, however the translator chip itself will interfere unless it is disabled. In the right figure a jumper (also called a shorting block or shunt) has been placed over the 2-pin header to the left of the translator. This effectively disables the translator and all connections for P8 through P15 at the I/O header. Once a translator is disabled you can connect directly to the Propeller I/O pins. Always use caution when connecting directly to the I/O pins that you’re using the correct signal voltage (3.3 V) and that the I/O pin direction is set properly since there is no additional protection for the I/O lines when connecting directly to them. Jumper: Parallax #452-00009; 40-pin male/male header: Parallax #451-04001.

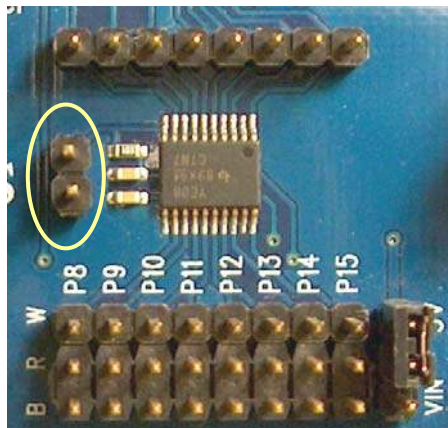

Translator Enabled
8-pin bypass header and 2-pin translator header installed. Jumper *not* installed.

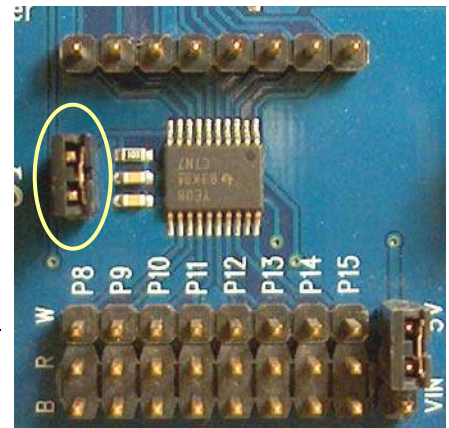

Translator Disabled
Jumper installed on 2-pin translator header.

VIN, 5 V, and 3.3 V Power Access Headers [17]

These sockets provide convenient access to the 3 power rails and can typically be jumpered over to the power bus on the breadboard using standard jumper wires. NOTE: VIN access on this header always has power when a power source is connected to the board, regardless of the position of the 3-position switch.

Ground/Mounting Vias [18]

The Mounting Vias are sized and positioned to be compatible with many of our popular microcontroller development platforms. All four of these holes are connected to the PCB’s ground plane.

Testing Communication

Parts Required

- Assembled Stingray Robot
 - USB A to Mini B Cable
 - (2) Red LED (from PE Kit Project Parts)
 - (2) 470 ohm resistor (from PE Kit Project Parts)
 - (2) Transistor, NPN, Switching, 200 mA
 - (3) Jumper Wire, F-M, 120 mm, 10-Pack
- ✓ Download and install the latest version of the Propeller Tool Software from the Downloads link at www.parallax.com/Propeller. Be sure to permit the installation/update of the FTDI USB drivers during installation.
 - ✓ Be sure the power switch on the control board is set to ALL OFF.
 - ✓ Connect the USB A connector to the PC and the Mini B side to the control board. Your PC should detect a new device and complete the installation of the drivers already available on the PC from when you installed the Propeller Tool if this has not already been done previously.
 - ✓ Run the Propeller Tool software. The first time you run the Propeller Tool you may be prompted with a file association dialog box. If so, click 'Yes' to associate the common extensions for Propeller programs with the Propeller Tool software.
 - ✓ Slide the power switch to the POWER ON / MOTORS OFF (middle) position to turn on the control board. You should see the green power LED light up, as shown at right.
 - If it does not, slide the power switch to ALL OFF to turn the control board off. Double check all your connections and try again.
 - If you see a red LED instead this is an indicator that your batteries input voltage is below 6V. This usually indicates low batteries; replace your batteries.
 - ✓ With the control board powered and the Propeller Tool running on your PC press the F7 key to identify connected hardware. You may also do this from the Propeller Tool menu system by clicking Run → Identify Hardware...



The Propeller Tool will scan all COM ports searching for a connected Propeller chip and display a message similar to the figure at right. Once scanning is complete you will see a message box like the one in the figure below left if a Propeller chip is detected or like figure below right if no Propeller chips were found.



- ✓ If you are unable to detect your Propeller chip recheck your connections and try again.
- ✓ If you continue to have difficulty please contact our Tech Support using the resources located at the end of this documentation.



Conserve energy! Be sure to turn off the power when not downloading or running a program on the control board. This will help conserve batteries and prevent accidents when wiring new circuits or connecting accessories to the control board.

Protect your hardware! You should also turn off power to the board when building a new circuit to prevent damaging any components.

- ✓ Use the LEDs, resistors and pluggable wires to create the circuit shown in schematic below on the breadboard. The pluggable wires will jumper to the breadboard to make the I/O and ground connections from the control board locations shown below. Ground can be obtained from the bottom row of pins (marked B) on the I/O headers. P0 and P1 are picked up from the top row (marked W) and are indicated on the silkscreen on the control board. Power is obtained from the center row (marked R) and its voltage is set by the jumper immediately to the right of that group of headers.

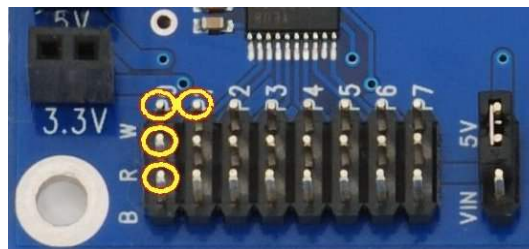
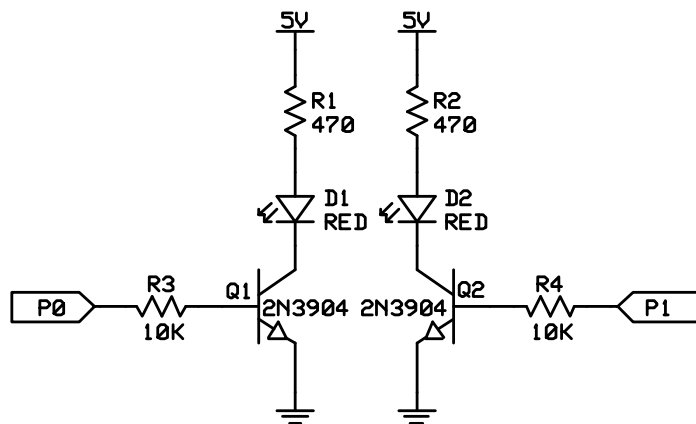

- ✓ Download the example code from the Stingray product page at www.parallax.com.
- ✓ Load the program LED Test.spin into the Propeller Tool.
- ✓ Slide the power switch on the control board to the middle position. The Green power LED should light up. In the Propeller Tool software press the F10 key to download the LED Test.spin code to the control board. If your circuit was wired correctly the two LEDs should start flashing back and forth every second.

```
'' File: LED Test.spin

CON
_xinfreq = 5_000_000          ' External Crystal Frequency
_clkmode = xtall1 + pll16x    ' Enabled External Crystal and PLL X16

PUB Main
  dira[1..0] := %11           ' Set P0 And P1 To Output
  repeat
    outa[0] := 1              ' P0 HIGH
    outa[1] := 0              ' P1 LOW
    waitcnt(clkfreq / 2 + cnt) ' Delay 1/2 Clock Frequency (1/2 Second)
    outa[0] := 0              ' P0 LOW
    outa[1] := 1              ' P1 HIGH
    waitcnt(clkfreq / 2 + cnt) ' Delay 1/2 Clock Frequency (1/2 Second)
```

- ✓ Once the test has completed, turn the power off and remove the components from the breadboard and disconnect the pluggable wires from the control board.
- ✓ Leave the USB cable and power supply connected as you will need them for the motor test coming up.

Driving Brushed DC Motors

This section will guide you through connecting and testing the DC Brushed Gear Motors included with the Stingray robot. Familiarizing yourself with the motors included in the Stingray robot kit will help you take advantage of the benefits of using these motors as well as understanding the nuances.

DC motors are usually driven by an H-Bridge since such a circuit can reverse the polarity of the motor connected to it. The DC brushed motors included in this kit are driven by the L6205 H-Bridge on the Propeller Robot Control Board. Understanding how to control this H-Bridge is the key to controlling the direction, speed and duration that the motors are on or off.

Parallax has released a Propeller object called, "PWM_32" which makes it easy to drive servos as well as control motors using pulse width modulation. This object can be used with the Propeller Robot Control Board to drive the on-board H-Bridge, which in turn drives the DC motors. This object can be downloaded from the Stingray robot product page on our website or from the Propeller object exchange listed in the Useful Websites section at the end of this document.

Brushed DC Spur-Gear Motors

The Stingray robot was designed to be fast when needed and as such a method of locomotion was chosen to support this requirement. Servo motors used in many smaller robots are too slow and have too little load capacity for the Stingray. Instead, brushed DC gear motors were selected. Specifically the motors used are known as Spur-Gear motors. These motors provide a good value and performance in a reasonably sized package.

The motors included in the Stingray kit have the following specifications:

- 7.2 VDC Nominal @ ~180 mA (no load)
- 310 RPM (30:1 gear ratio on output shaft)
- 6mm diameter output shaft w/5.5mm detent for hubs with set screws
- Output shaft length: 18 mm (0.70")
- Motor shaft extends from back of motor allowing encoder support
- Motor shaft length: 10 mm (0.40")
- Four M3 size mounting holes



Internally the Spur-gear motor looks like the picture shown below, left. The back side of the motor is shown in the figure on the right. Take note of the (+) sign that is used to indicate polarity. While motors don't have a specific polarity per se, the plus signs help to match polarity of the motors on either side so you know the direction the motor will turn when you apply power to it. When you apply power to the motor so that the positive supply is connected to the (+) terminal and the other terminal connects to ground the internal motor shaft turns clockwise while the output shaft spins counter-clockwise.



Spur-gear motor
internals



Back side of motor; note
the ⊕ symbol to help
match polarity.

The motors are designed to run nominally at 7.2 VDC. This voltage was chosen due to the popularity of 7.2 V R/C battery packs used as power sources on robots and in R/C cars. Running the motors at voltages higher than 7.2 V can wear the brushes out quicker, reducing the life of the motor. Keep this in mind if you connect an external power supply into the Propeller Robot Control Board as the input voltage at the power connector is what is fed to the motors through the H-Bridge. Often wall supplies have a higher output voltage than what they are rated at when not at their full output current. We recommend our 7.5 V, 1 A power supply #750-00009.

Another thing to keep in mind with DC motors is that two motors of the same model given the same voltage may not spin at exactly the same speed. This is due to variations in the internal coils, magnets, etc. Similar to calibrating continuous rotation servos, DC motors must be calibrated in software to ensure the robot goes in a straight line. Because the motor shaft extends from the back of the motor you could also employ optical encoders and program your motor drive code to adjust motor speed based on feedback provided by the encoders, but that is a topic for a future update.

Testing the Motors

- ✓ Load the programs Left Motor Test.spin and Right Motor Test.spin into the Propeller Tool.
- ✓ Slide the power switch on the control board to the second position (POWER ON/MOTORS ON).
- ✓ Select each program one at a time and download it to the Stingray robot by pressing the F10 key.
- ✓ Observe the results. Each motor should rotate forward for two seconds, stop for 2 seconds and rotate reverse for 2 seconds.

```
'' File: Left Motor Test.spin

CON
_xinfreq = 5_000_000      ' External Crystal Frequency
_clkmode = xtall1 + pll16x ' Enabled External Crystal and PLL X16

PUB Main
  dira[27..24] := %1111   ' Set P24 Through P27 To Output

  outa[25] := 1           ' Left Motor Forward
  waitcnt(clkfreq * 2 + cnt) ' 2 Second Pause
  outa[25] := 0           ' Left Motor Stop
  waitcnt(clkfreq * 2 + cnt) ' 2 Second Pause
  outa[24] := 1           ' Left Motor Reverse
  waitcnt(clkfreq * 2 + cnt) ' 2 Second Pause
  outa[24] := 0           ' Left Motor Stop
  repeat
```

```
'' File: Right Motor Test.spin

CON
_xinfreq = 5_000_000      ' External Crystal Frequency
_clkmode = xtall1 + pll16x ' Enabled External Crystal and PLL X16

PUB Main
  dira[27..24] := %1111   ' Set P24 Through P27 To Output

  outa[26] := 1           ' Right Motor Forward
  waitcnt(clkfreq * 2 + cnt) ' 2 Second Pause
  outa[26] := 0           ' Right Motor Stop
  waitcnt(clkfreq * 2 + cnt) ' 2 Second Pause
  outa[27] := 1           ' Right Motor Reverse
  waitcnt(clkfreq * 2 + cnt) ' 2 Second Pause
  outa[27] := 0           ' Right Motor Stop
  repeat
```

Troubleshooting the Motors

If the motors do not respond as expected then the following troubleshooting steps should help you correct most issues. If none of these troubleshooting steps solves your issue or if your issue is not listed you may contact our Tech Support using the resources listed at the bottom of this page.

Symptom: The motors do not move at all, but the program downloads successfully.

Check: The power switch may be in the POWER ON/MOTORS OFF position instead of POWER ON/MOTORS ON.

Symptom: The motor rotates in reverse for two seconds, stops for two seconds then rotates forward for two seconds.

Check: The motor leads may be reversed on the motor. Remove the top plate from the chassis and swap the wires on the motor terminals for the side that was affected.

Symptom: The motor starts to turn forward then stops, then starts to turn forward again.

Check: The batteries may be running low. Try a fresh set of batteries.

Additional Resources

Resources for the Stingray such as example code are posted to the Stingray product page on our website. Go to our website at www.parallax.com and type the product number (28980) into the search box and click the Go button. The example code will be in a ZIP file located under the heading Downloads and Resources. Save the contents of the ZIP file to a known folder for use in later activities in the book. Over time additional resources, videos, and accessories will be added so check back often as these will be linked from the Stingray product web page.

Useful Websites

In addition to the resources available on the Stingray product page you can get additional resources such as useful objects for sensors from the following links:

- Propeller Home Page: <http://www.parallax.com/propeller>
- Object Exchange: <http://obex.parallax.com>
- Support/Discussion Forums: <http://forums.parallax.com> → Propeller Chip

Tech Support Resources

Parallax Inc. offers several options for obtaining technical support for your product:

- Email: support@parallax.com
- Fax: (916) 624-8003
- Phone: (916) 624-8333 or toll-free in the U.S. at (888) 99-STAMP. Phone support is available Monday through Friday from 7:00 AM to 5:00 PM Pacific time or you can leave a message and a tech support representative will return your call as soon as possible.
- Forums: <http://forums.parallax.com>. Our support forums are available 24 hours a day, 7 days a week and are frequented by both Parallax customers and employees. You can often find fast answers to questions by searching previous posts or posting your question to the Propeller chip forum.