

STRADA-2X2-PX

Fully asymmetric beam designed to highlight pedestrian crossings for right side traffic

SPECIFICATION:

Dimensions	50.0 x 50.0 mm
Height	8 mm
Fastening	pin, screw
ROHS compliant	yes ⓘ



MATERIALS:

Component	Type	Material	Colour	Finish
STRADA-2X2-PX	Multi-lens	PMMA	clear	

ORDERING INFORMATION:

Component	Qty in box	MOQ	MPQ	Box weight (kg)
C14116_STRADA-2X2-PX » Box size: 480 x 280 x 300 mm	800	160	160	7.9

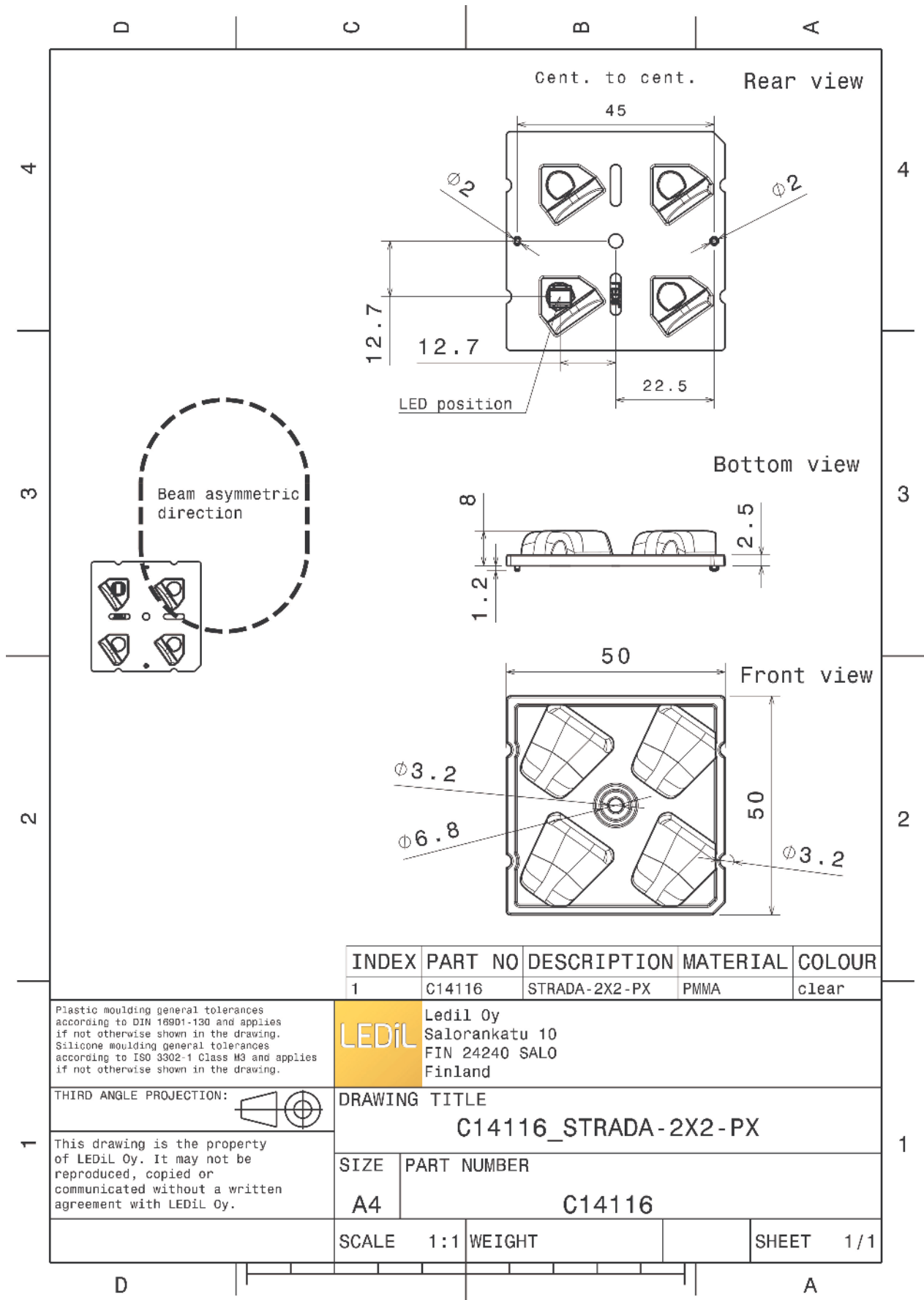

INDEX	PART NO	DESCRIPTION	MATERIAL	COLOUR
1	C14116	STRADA-2X2-PX	PMMA	clear

Plastic moulding general tolerances according to DIN 16901-130 and applies if not otherwise shown in the drawing. Silicone moulding general tolerances according to ISO 3302-1 Class M3 and applies if not otherwise shown in the drawing.

LEDiL Ledil Oy
Salorankatu 10
FIN 24240 SALO
Finland

THIRD ANGLE PROJECTION:

DRAWING TITLE
C14116_STRADA-2X2-PX







This drawing is the property of LEDiL Oy. It may not be reproduced, copied or communicated without a written agreement with LEDiL Oy.

SIZE	PART NUMBER
A4	C14116

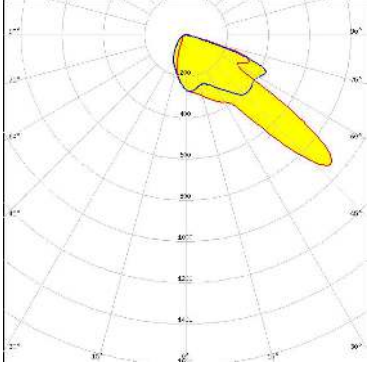
SCALE	1:1	WEIGHT	SHEET	1/1
-------	-----	--------	-------	-----

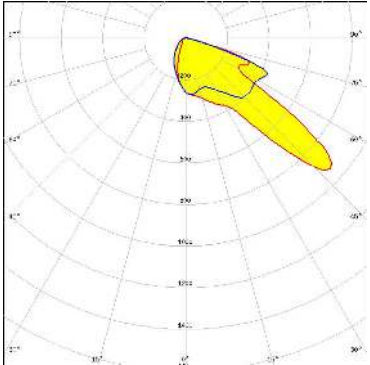
See also our general installation guide: www.ledil.com/installation_guide

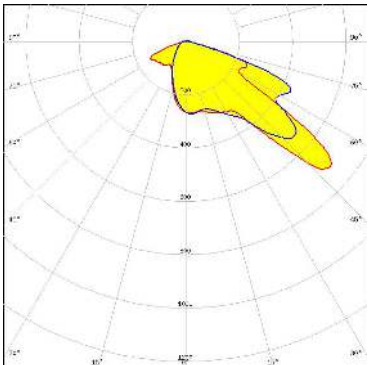
OPTICAL RESULTS (MEASURED):

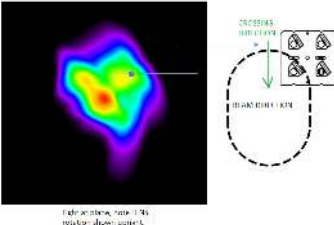
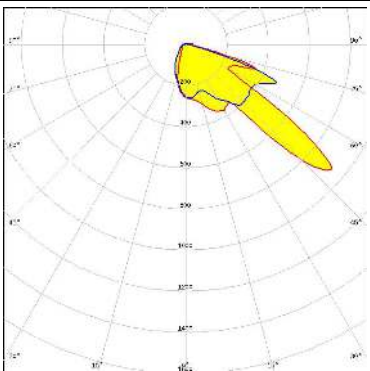
 <p>LED QUICK FLUX XTP 2x4 xxx LS G5 FWHM / FWTM Asymmetric Efficiency 94 % Peak intensity 1 cd/lm LEDs/each optic 1 Light colour White Required components:</p>	
 <p>LED QUICK FLUX XTP 2x6 xxx LS G5 FWHM / FWTM Asymmetric Efficiency 94 % Peak intensity 1 cd/lm LEDs/each optic 1 Light colour White Required components:</p>	
 <p>LED QUICK FLUX XTP 2x8 xxx LS G5 FWHM / FWTM Asymmetric Efficiency 94 % Peak intensity 0.8 cd/lm LEDs/each optic 1 Light colour White Required components:</p>	
 <p>LED XB-D FWHM / FWTM Asymmetric Efficiency 94 % Peak intensity 1 cd/lm LEDs/each optic 1 Light colour White Required components:</p>	 <p style="font-size: small;">Light at 1000nm, mode 1: 100 resolution: 100nm x 100nm</p> 

OPTICAL RESULTS (MEASURED):

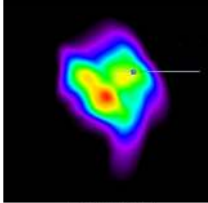
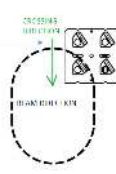
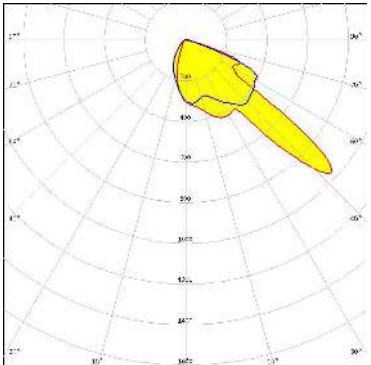
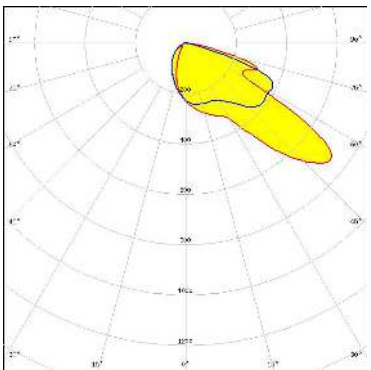
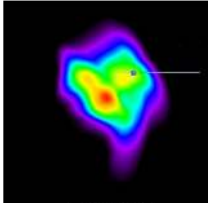
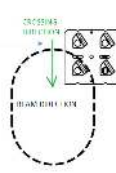
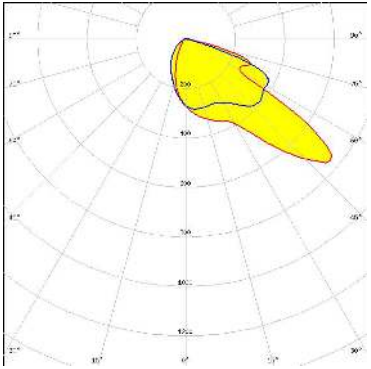
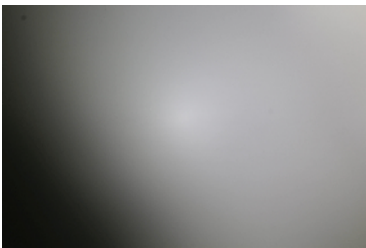
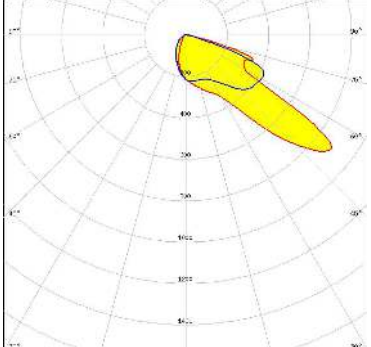
<p>CREE ⇄ LED</p> <p>LED XB-H FWHM / FWTM Asymmetric Efficiency 94 % Peak intensity 1 cd/lm LEDs/each optic 1 Light colour White Required components:</p>	 <p>Light on plane, note: 1/4s resolution (down) center 1.</p> 	
<p>CREE ⇄ LED</p> <p>LED XM-L FWHM / FWTM Asymmetric Efficiency 94 % Peak intensity 0.8 cd/lm LEDs/each optic 1 Light colour White Required components:</p>		
<p>CREE ⇄ LED</p> <p>LED XM-L2 FWHM / FWTM Asymmetric Efficiency 94 % Peak intensity 0.8 cd/lm LEDs/each optic 1 Light colour White Required components:</p>	 <p>Light on plane, note: 1/4s resolution (down) center 1.</p> 	
<p>CREE ⇄ LED</p> <p>LED XM-L3 FWHM / FWTM Asymmetric Efficiency 97 % Peak intensity 0.9 cd/lm LEDs/each optic 1 Light colour White Required components:</p>		

OPTICAL RESULTS (MEASURED):

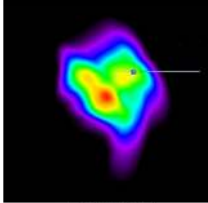
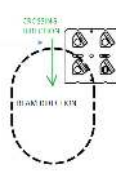
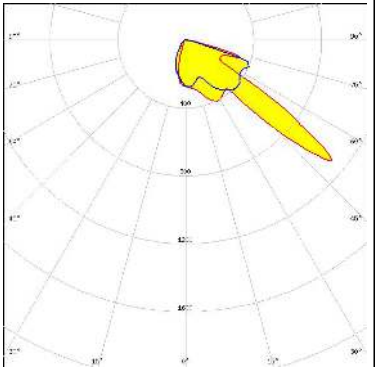
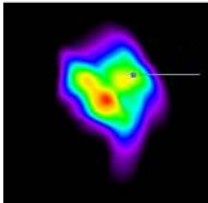
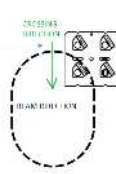
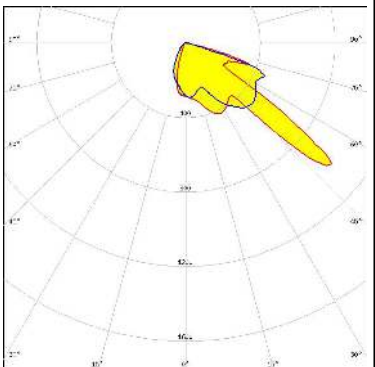
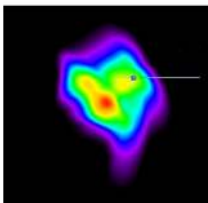
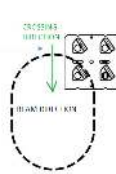
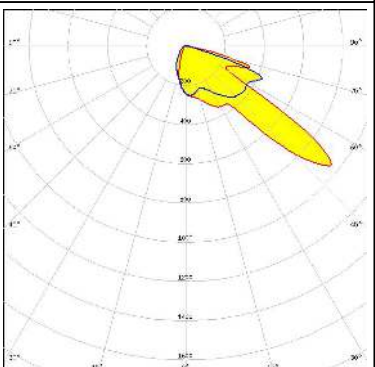
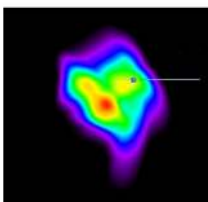
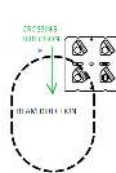
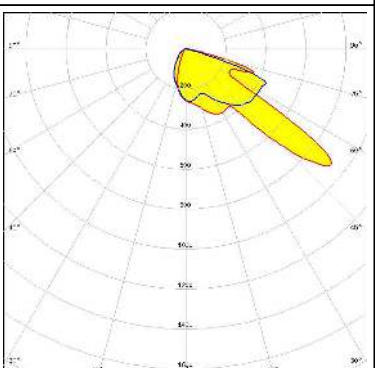
CREE ⇄ LED	<p>LED: XP-E FWHM / FWTM: Asymmetric Efficiency: 94 % Peak intensity: 1.2 cd/lm LEDs/each optic: 1 Light colour: White Required components:</p>	 <p>Light at 0° elev., 0° 174° rotation (down) center's.</p> 	
CREE ⇄ LED	<p>LED: XP-E2 FWHM / FWTM: Asymmetric Efficiency: 94 % Peak intensity: 1.2 cd/lm LEDs/each optic: 1 Light colour: White Required components:</p>	 <p>Light at 0° elev., 0° 174° rotation (down) center's.</p> 	
CREE ⇄ LED	<p>LED: XP-G FWHM / FWTM: Asymmetric Efficiency: 94 % Peak intensity: 1 cd/lm LEDs/each optic: 1 Light colour: White Required components:</p>	 <p>Light at 0° elev., 0° 174° rotation (down) center's.</p> 	
CREE ⇄ LED	<p>LED: XP-G2 FWHM / FWTM: Asymmetric Efficiency: 94 % Peak intensity: 1 cd/lm LEDs/each optic: 1 Light colour: White Required components:</p>	 <p>Light at 0° elev., 0° 174° rotation (down) center's.</p> 	

OPTICAL RESULTS (MEASURED):

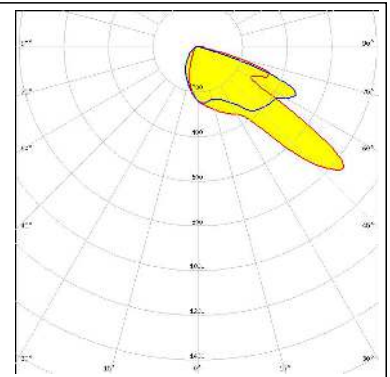
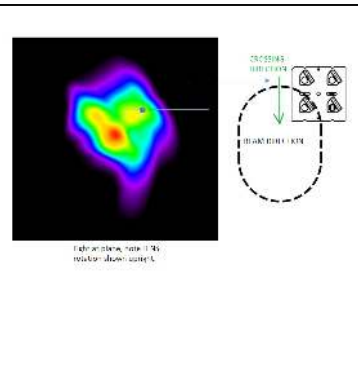
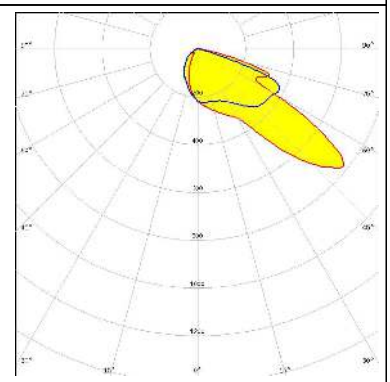
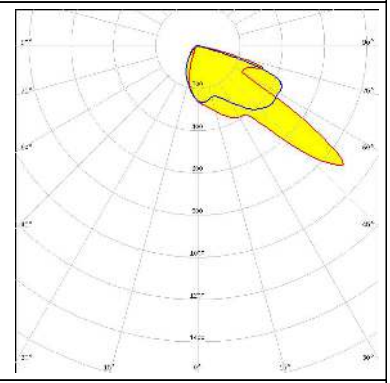
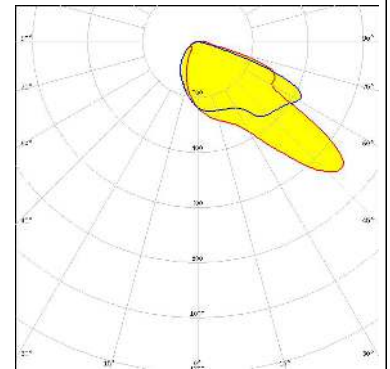
<p>CREE → LED</p> <p>LED: XP-G3 FWHM / FWTM: Asymmetric Efficiency: 94 % Peak intensity: 0.9 cd/lm LEDs/each optic: 1 Light colour: White Required components:</p>		
<p>CREE → LED</p> <p>LED: XP-L HD FWHM / FWTM: Asymmetric Efficiency: 94 % Peak intensity: 0.8 cd/lm LEDs/each optic: 1 Light colour: White Required components:</p>		
<p>CREE → LED</p> <p>LED: XP-L HI FWHM / FWTM: Asymmetric Efficiency: 94 % Peak intensity: 1 cd/lm LEDs/each optic: 1 Light colour: White Required components:</p>		
<p>CREE → LED</p> <p>LED: XP-L2 FWHM / FWTM: Asymmetric Efficiency: 94 % Peak intensity: 0.7 cd/lm LEDs/each optic: 1 Light colour: White Required components:</p>		

OPTICAL RESULTS (MEASURED):

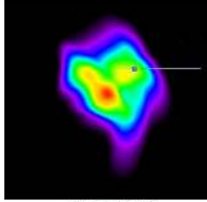
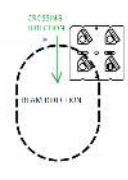
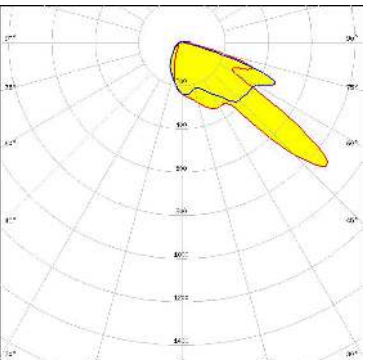
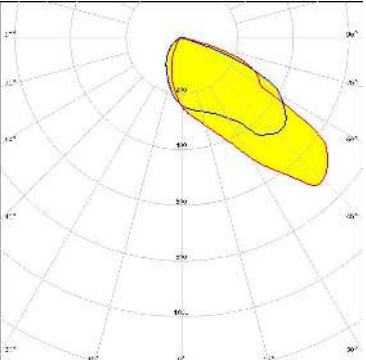
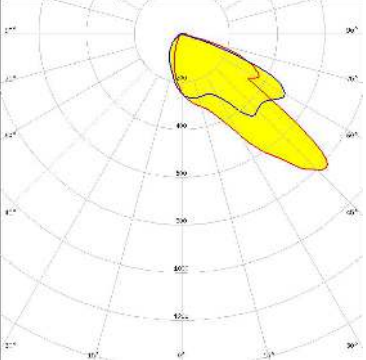
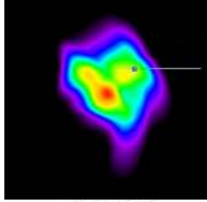
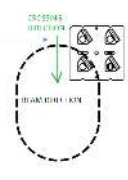
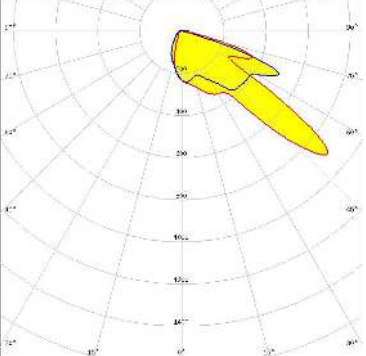
<p>CREE  LED</p> <p>LED: XT-E FWHM / FWTM: Asymmetric Efficiency: 94 % Peak intensity: 1 cd/lm LEDs/each optic: 1 Light colour: White Required components:</p>	 <p>Light at 0.2m, note: 0.7% resolution down to 0.1°</p> 	
<p>LUMILEDS</p> <p>LED: LUXEON 5050 Round LES FWHM / FWTM: Asymmetric Efficiency: 94 % Peak intensity: 0.8 cd/lm LEDs/each optic: 1 Light colour: White Required components:</p>		
<p>LUMILEDS</p> <p>LED: LUXEON MZ FWHM / FWTM: Asymmetric Efficiency: 94 % Peak intensity: 0.9 cd/lm LEDs/each optic: 1 Light colour: White Required components:</p>		
<p>LUMILEDS</p> <p>LED: LUXEON Q FWHM / FWTM: Asymmetric Efficiency: 94 % Peak intensity: 1 cd/lm LEDs/each optic: 1 Light colour: White Required components:</p>	 <p>Light at 0.2m, note: 0.7% resolution down to 0.1°</p> 	

OPTICAL RESULTS (MEASURED):

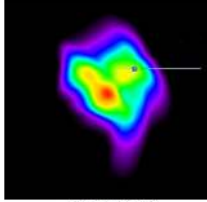
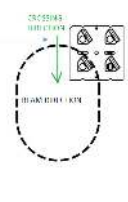
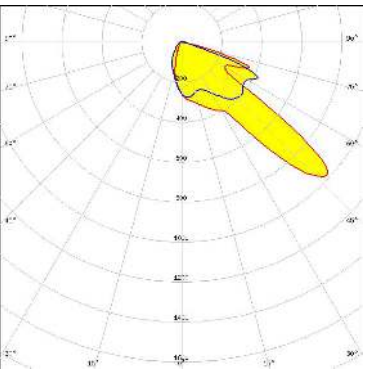
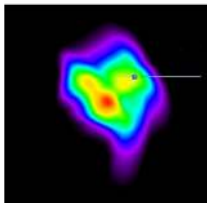
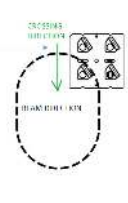
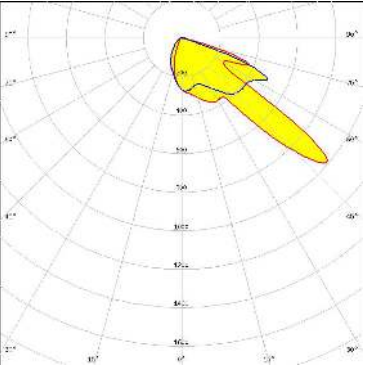
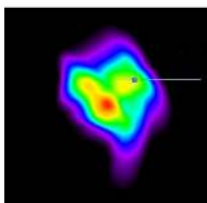
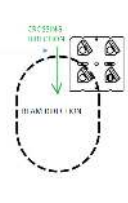
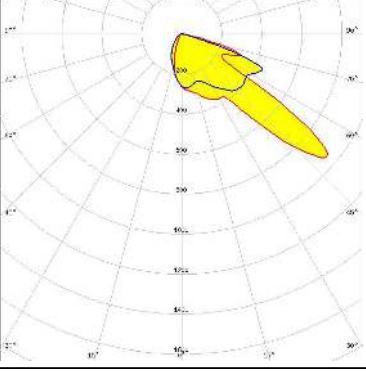
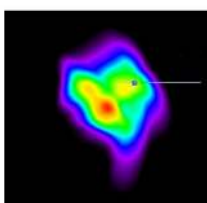
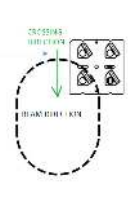
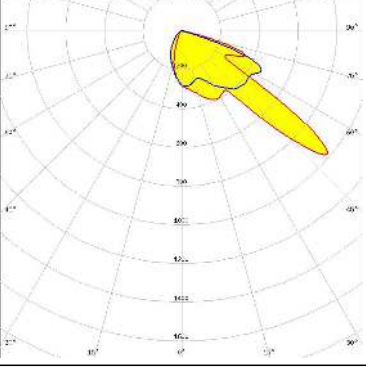
<p>LUMILEDS</p> <p>LED LUXEON R</p> <p>FWHM / FWTM Asymmetric</p> <p>Efficiency 94 %</p> <p>Peak intensity 1 cd/lm</p> <p>LEDs/each optic 1</p> <p>Light colour White</p> <p>Required components:</p>	 <p>Light at 0° beam, note: 0° 0° rotation (downward) center 0°</p>		
<p>LUMILEDS</p> <p>LED LUXEON Rebel ES</p> <p>FWHM / FWTM Asymmetric</p> <p>Efficiency 94 %</p> <p>Peak intensity 1.1 cd/lm</p> <p>LEDs/each optic 1</p> <p>Light colour White</p> <p>Required components:</p>	 <p>Light at 0° beam, note: 0° 0° rotation (downward) center 0°</p>		
<p>LUMILEDS</p> <p>LED LUXEON T</p> <p>FWHM / FWTM Asymmetric</p> <p>Efficiency 94 %</p> <p>Peak intensity 1 cd/lm</p> <p>LEDs/each optic 1</p> <p>Light colour White</p> <p>Required components:</p>	 <p>Light at 0° beam, note: 0° 0° rotation (downward) center 0°</p>		
<p>LUMILEDS</p> <p>LED LUXEON TX</p> <p>FWHM / FWTM Asymmetric</p> <p>Efficiency 94 %</p> <p>Peak intensity 1.1 cd/lm</p> <p>LEDs/each optic 1</p> <p>Light colour White</p> <p>Required components:</p>	 <p>Light at 0° beam, note: 0° 0° rotation (downward) center 0°</p>		

OPTICAL RESULTS (MEASURED):

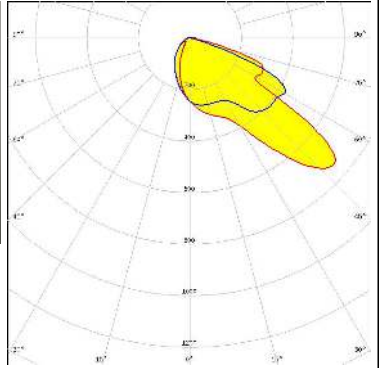
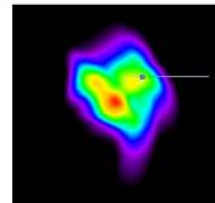
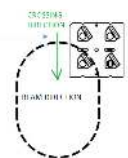
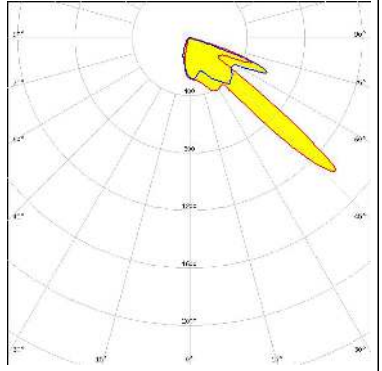
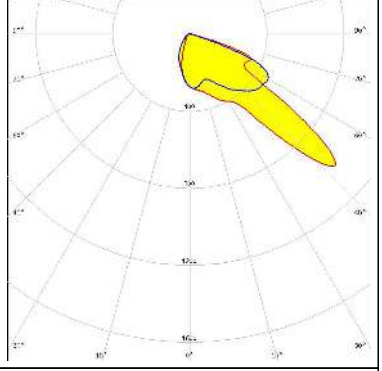
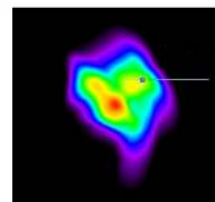
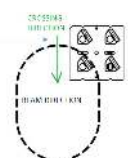
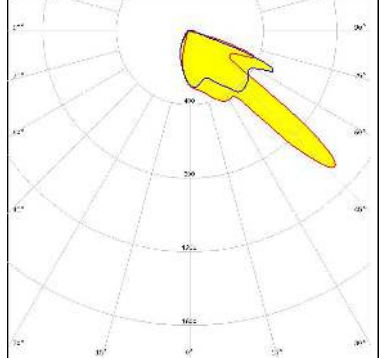
<p>LUMILEDS</p> <p>LED LUXEON V</p> <p>FWHM / FWTM Asymmetric</p> <p>Efficiency 94 %</p> <p>Peak intensity 0.8 cd/lm</p> <p>LEDs/each optic 1</p> <p>Light colour White</p> <p>Required components:</p>		
<p>LUMILEDS</p> <p>LED LUXEON Z ES</p> <p>FWHM / FWTM Asymmetric</p> <p>Efficiency 94 %</p> <p>Peak intensity 1.4 cd/lm</p> <p>LEDs/each optic 1</p> <p>Light colour White</p> <p>Required components:</p>	 <p>Light at 0.5m, note: 1.44 mcd/cm² at 0.5m</p> 	
<p>MST Your solutions</p> <p>LED RecLED 122x50mm 1900lm 730 2x4 Opt G1</p> <p>FWHM / FWTM Asymmetric</p> <p>Efficiency 97 %</p> <p>Peak intensity 1.1 cd/lm</p> <p>LEDs/each optic 1</p> <p>Light colour White</p> <p>Required components:</p>		
<p>NICHIA</p> <p>LED NCSxx19A</p> <p>FWHM / FWTM Asymmetric</p> <p>Efficiency 94 %</p> <p>Peak intensity 1.2 cd/lm</p> <p>LEDs/each optic 1</p> <p>Light colour White</p> <p>Required components:</p>	 <p>Light at 0.5m, note: 1.44 mcd/cm² at 0.5m</p> 	

OPTICAL RESULTS (MEASURED):

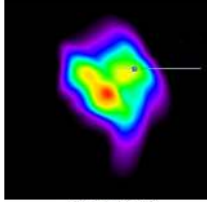
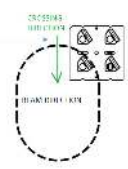
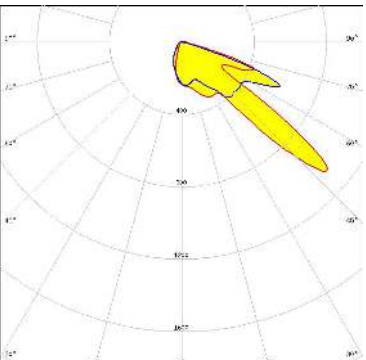
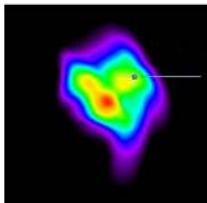
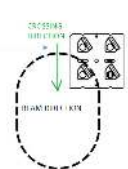
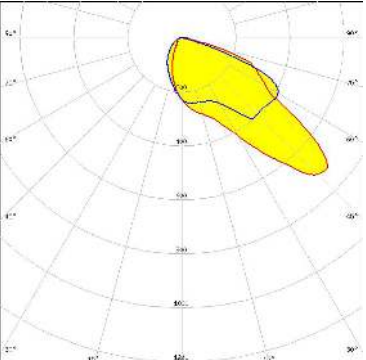
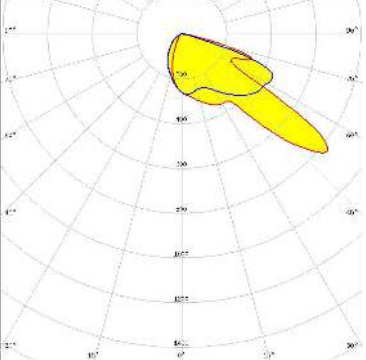
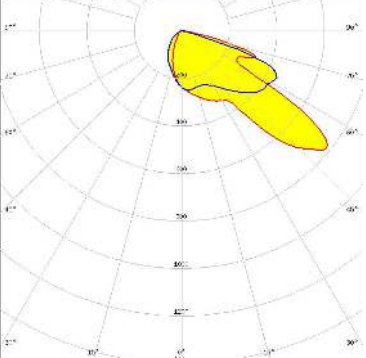
<p>NICHIA</p> <p>LED NCSxx19B FWHM / FWTM Asymmetric Efficiency 94 % Peak intensity 1.1 cd/lm LEDs/each optic 1 Light colour White Required components:</p>	 <p>Light in stream, note: 1.74 resolution: 0.0001 cd/m²</p>	 <p>DECREASES INCREASES BEAM SPREAD RATE</p>	
<p>NICHIA</p> <p>LED NS9x383 FWHM / FWTM Asymmetric Efficiency 94 % Peak intensity 0.8 cd/lm LEDs/each optic 1 Light colour White Required components:</p>	 <p>Light in stream, note: 1.74 resolution: 0.0001 cd/m²</p>	 <p>DECREASES INCREASES BEAM SPREAD RATE</p>	
<p>NICHIA</p> <p>LED NVSW219F FWHM / FWTM Asymmetric Efficiency 94 % Peak intensity 0.9 cd/lm LEDs/each optic 1 Light colour White Required components:</p>			
<p>NICHIA</p> <p>LED NVSW319B FWHM / FWTM Asymmetric Efficiency 94 % Peak intensity 0.9 cd/lm LEDs/each optic 1 Light colour White Required components:</p>			

OPTICAL RESULTS (MEASURED):

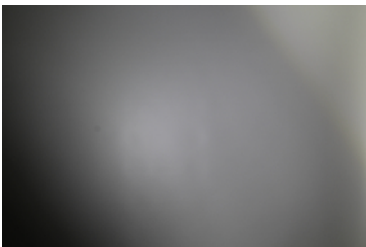
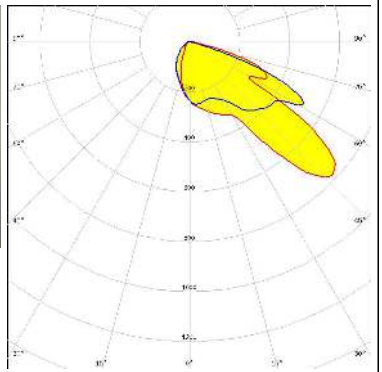
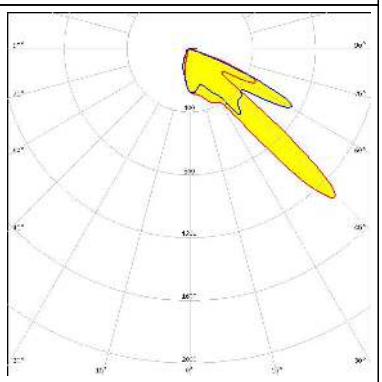
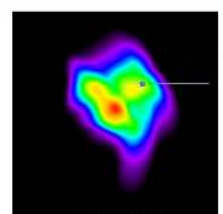
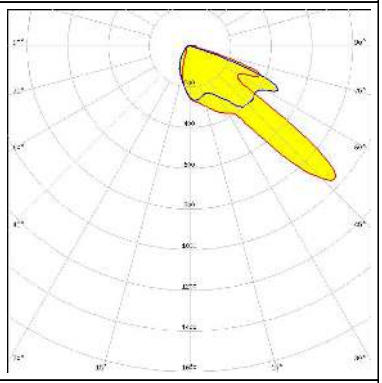
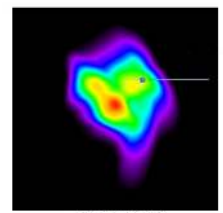
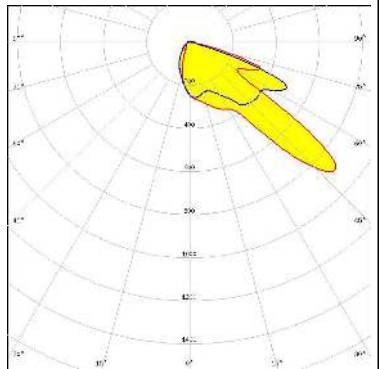
<p>NICHIA</p> <p>LED NVSW3x9A FWHM / FWTM Asymmetric Efficiency 94 % Peak intensity 0.8 cd/lm LEDs/each optic 1 Light colour White Required components:</p>		
<p>NICHIA</p> <p>LED NVSxE21A FWHM / FWTM Asymmetric Efficiency 94 % Peak intensity 1.4 cd/lm LEDs/each optic 1 Light colour White Required components:</p>		
<p>NICHIA</p> <p>LED NVSxx19A FWHM / FWTM Asymmetric Efficiency 94 % Peak intensity 1 cd/lm LEDs/each optic 1 Light colour White Required components:</p>	 <p>Light at 0.5m, note: 1.74x reduction (down) water 1.</p>	
<p>NICHIA</p> <p>LED NVSxx19B/NVSxx19C FWHM / FWTM Asymmetric Efficiency 94 % Peak intensity 0.9 cd/lm LEDs/each optic 1 Light colour White Required components:</p>	 <p>Light at 0.5m, note: 1.74x reduction (down) water 1.</p>	

OPTICAL RESULTS (MEASURED):

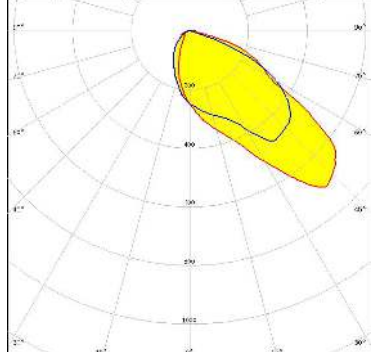
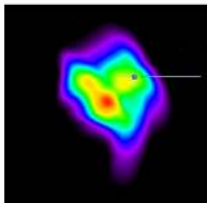
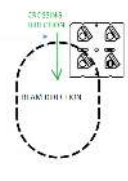
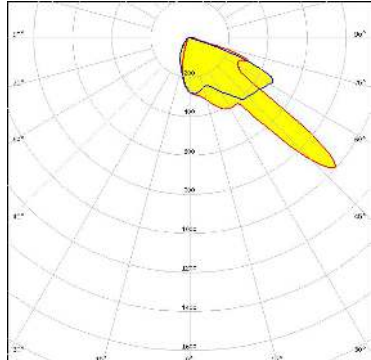
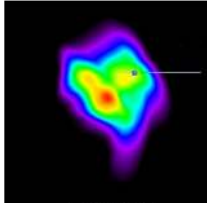
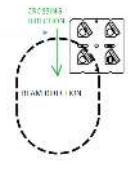
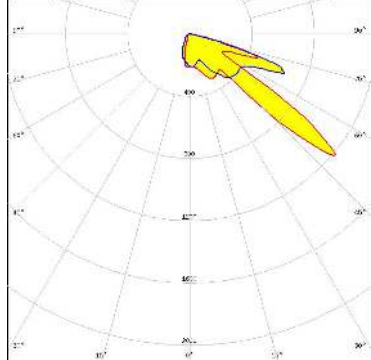
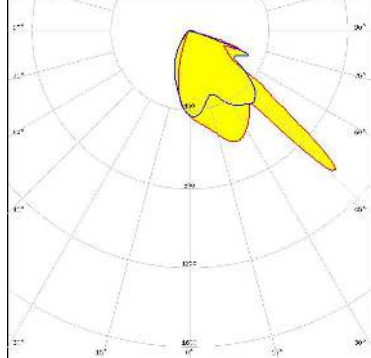
<p>OSRAM Opto Semiconductors</p> <p>LED Duris S8</p> <p>FWHM / FWTM Asymmetric</p> <p>Efficiency 94 %</p> <p>Peak intensity 0.8 cd/lm</p> <p>LEDs/each optic 1</p> <p>Light colour White</p> <p>Required components:</p>		
<p>OSRAM Opto Semiconductors</p> <p>LED OSLOM Square PC</p> <p>FWHM / FWTM Asymmetric</p> <p>Efficiency 94 %</p> <p>Peak intensity 1.1 cd/lm</p> <p>LEDs/each optic 1</p> <p>Light colour White</p> <p>Required components:</p>	 <p>Light intensity, note: 1.1 cd/lm relative to beam center.</p> 	
<p>OSRAM Opto Semiconductors</p> <p>LED OSLOM SSL 150</p> <p>FWHM / FWTM Asymmetric</p> <p>Efficiency 94 %</p> <p>Peak intensity 1.3 cd/lm</p> <p>LEDs/each optic 1</p> <p>Light colour White</p> <p>Required components:</p>	 <p>Light intensity, note: 1.3 cd/lm relative to beam center.</p> 	
<p>OSRAM Opto Semiconductors</p> <p>LED OSLOM SSL 80</p> <p>FWHM / FWTM Asymmetric</p> <p>Efficiency 94 %</p> <p>Peak intensity 1.3 cd/lm</p> <p>LEDs/each optic 1</p> <p>Light colour White</p> <p>Required components:</p>		

OPTICAL RESULTS (MEASURED):

PHILIPS

LED Fortimo FastFlex LED 2x8 DA G4
 FWHM / FWTM Asymmetric
 Efficiency 94 %
 Peak intensity 1.1 cd/lm
 LEDs/each optic 1
 Light colour White
 Required components:

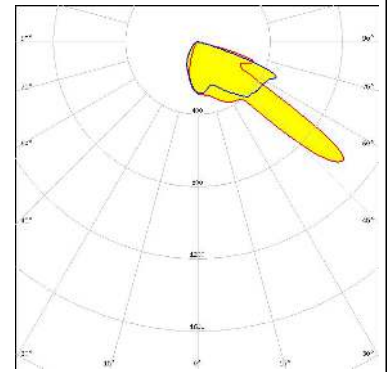

PHILIPS

LED Fortimo FastFlex LED 2x8 DA G4+
 FWHM / FWTM Asymmetric
 Efficiency 97 %
 Peak intensity 0.9 cd/lm
 LEDs/each optic 1
 Light colour White
 Required components:

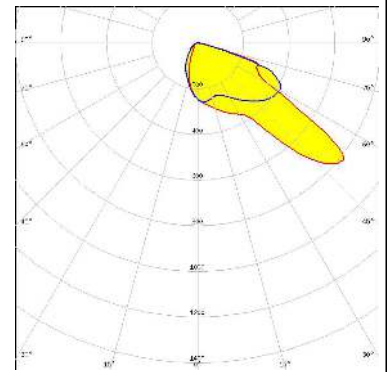

PHILIPS

LED Fortimo FastFlex LED 2x8 DAX G4
 FWHM / FWTM Asymmetric
 Efficiency 94 %
 Peak intensity 0.9 cd/lm
 LEDs/each optic 1
 Light colour White
 Required components:

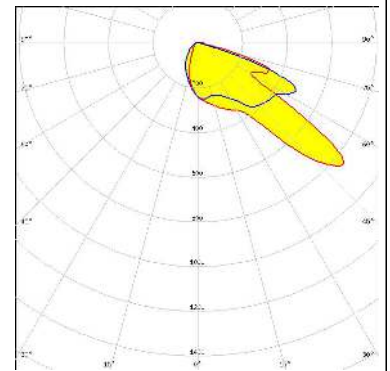

SAMSUNG

LED HiLOM RC12 Z (LH181B)
 FWHM / FWTM Asymmetric
 Efficiency 98 %
 Peak intensity 1.3 cd/lm
 LEDs/each optic 1
 Light colour White
 Required components:

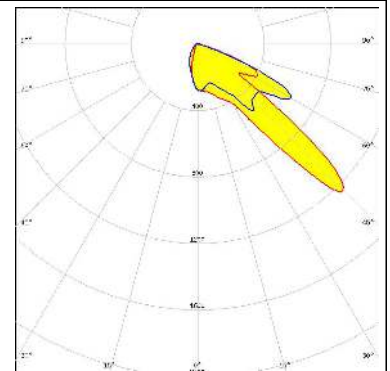

OPTICAL RESULTS (MEASURED):

SAMSUNG

LED HiLOM RC12 Z (LH181B)
 FWHM / FWTM Asymmetric
 Efficiency 91 %
 Peak intensity 1.3 cd/lm
 LEDs/each optic 1
 Light colour White
 Required components:

Protective plate, glass

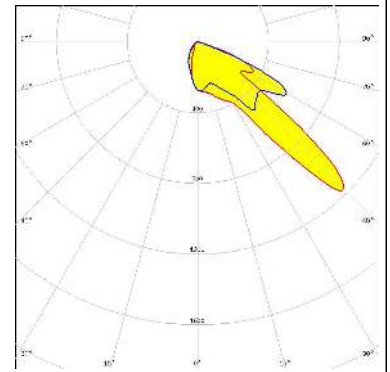

SAMSUNG

LED HiLOM RH12 Z (LH351C)
 FWHM / FWTM Asymmetric
 Efficiency 97 %
 Peak intensity 1 cd/lm
 LEDs/each optic 1
 Light colour White
 Required components:

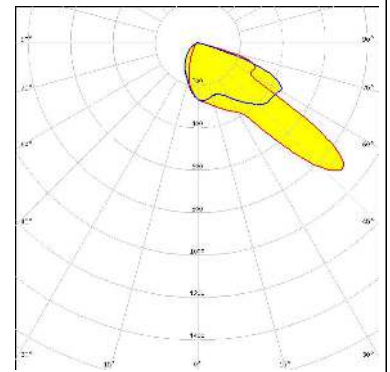

SAMSUNG

LED HiLOM RH16 (LH351C)
 FWHM / FWTM Asymmetric
 Efficiency 94 %
 Peak intensity 1 cd/lm
 LEDs/each optic 1
 Light colour White
 Required components:

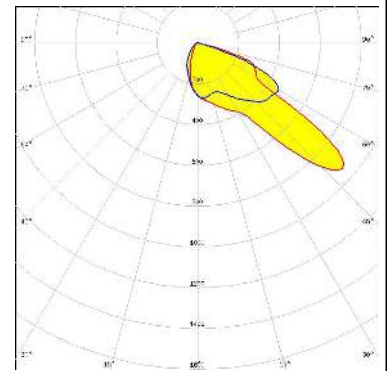

SAMSUNG

LED HiLOM RM12 Z (LH502C)
 FWHM / FWTM Asymmetric
 Efficiency 97 %
 Peak intensity 0.8 cd/lm
 LEDs/each optic 1
 Light colour White
 Required components:

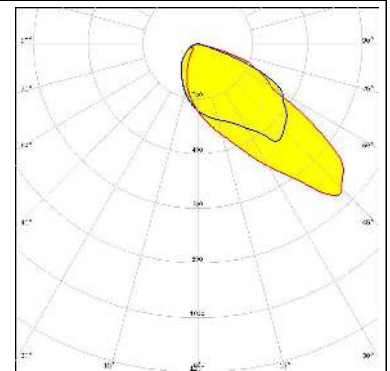

OPTICAL RESULTS (MEASURED):

SAMSUNG

LED HiLOM RM16 Z (LH502C)
 FWHM / FWTM Asymmetric
 Efficiency 98 %
 Peak intensity 0.8 cd/lm
 LEDs/each optic 1
 Light colour White
 Required components:

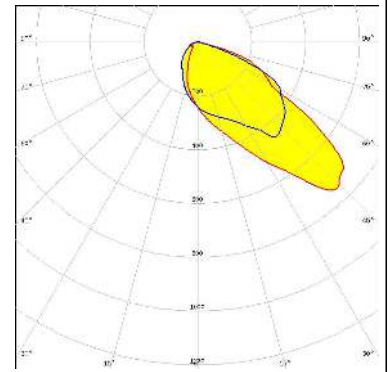

SAMSUNG

LED HiLOM RM16 Z (LH502C)
 FWHM / FWTM Asymmetric
 Efficiency 91 %
 Peak intensity 0.8 cd/lm
 LEDs/each optic 1
 Light colour White
 Required components:

Protective plate, glass

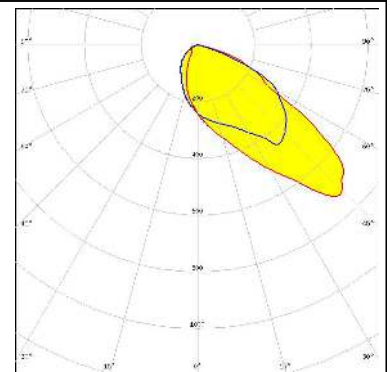

SAMSUNG

LED HiLOM RM8 Z (LH502C)
 FWHM / FWTM Asymmetric
 Efficiency 92 %
 Peak intensity 0.8 cd/lm
 LEDs/each optic 1
 Light colour White
 Required components:

Protective plate, glass

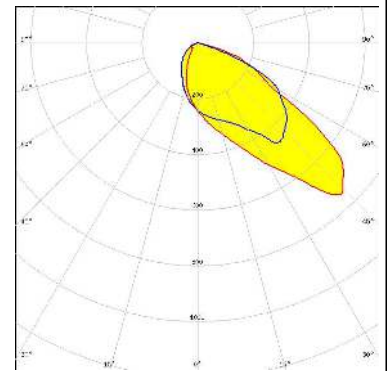

SAMSUNG

LED HiLOM RM8 Z (LH502C)
 FWHM / FWTM Asymmetric
 Efficiency 98 %
 Peak intensity 0.8 cd/lm
 LEDs/each optic 1
 Light colour White
 Required components:

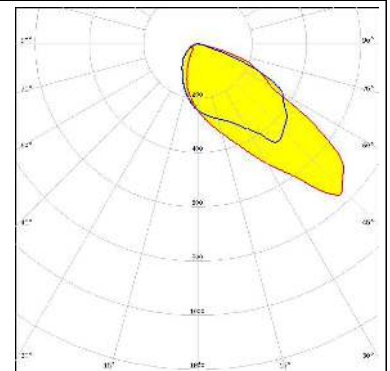

OPTICAL RESULTS (MEASURED):

SAMSUNG

LED LH351A
 FWHM / FWTM Asymmetric
 Efficiency 94 %
 Peak intensity 1.2 cd/lm
 LEDs/each optic 1
 Light colour White
 Required components:

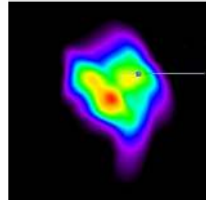

Light at 0° angle, note: 0.74% reduction (downward) water level.

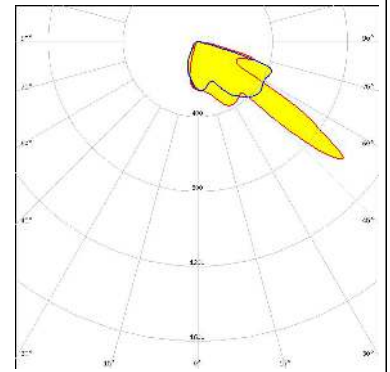

SAMSUNG

LED LH351B
 FWHM / FWTM Asymmetric
 Efficiency 94 %
 Peak intensity 0.9 cd/lm
 LEDs/each optic 1
 Light colour White
 Required components:

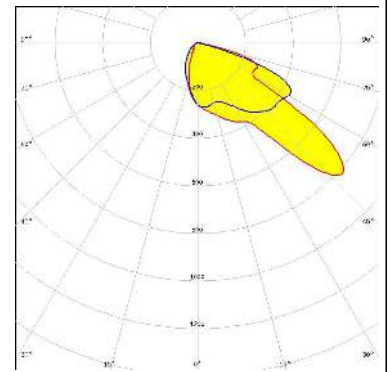

SAMSUNG

LED LH351Z
 FWHM / FWTM Asymmetric
 Efficiency 94 %
 Peak intensity 1 cd/lm
 LEDs/each optic 1
 Light colour White
 Required components:

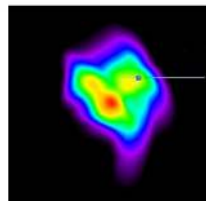

Light at 0° angle, note: 0.74% reduction (downward) water level.

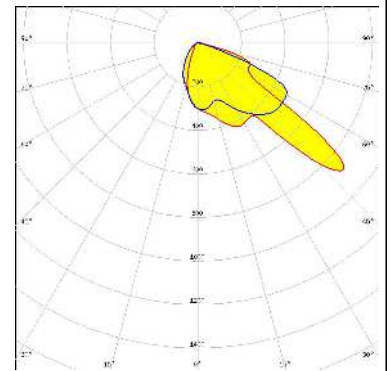



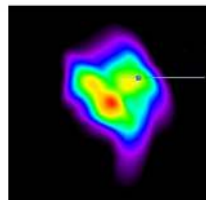

SEUL SEMICONDUCTOR
 LED Acrich MJT 4040
 FWHM / FWTM Asymmetric
 Efficiency 94 %
 Peak intensity 0.8 cd/lm
 LEDs/each optic 1
 Light colour White
 Required components:

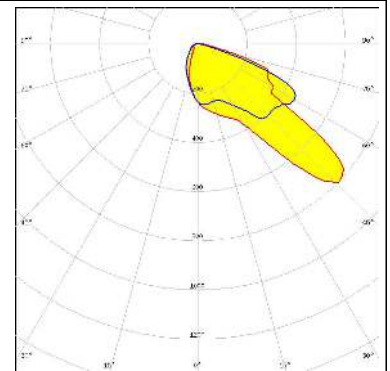

Light at 0° angle, note: 0.74% reduction (downward) water level.

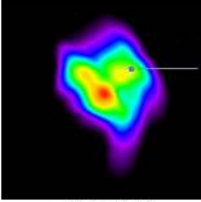

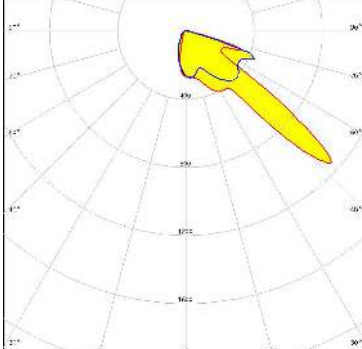
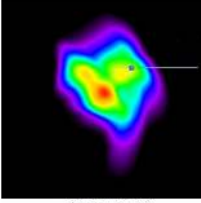
OPTICAL RESULTS (MEASURED):

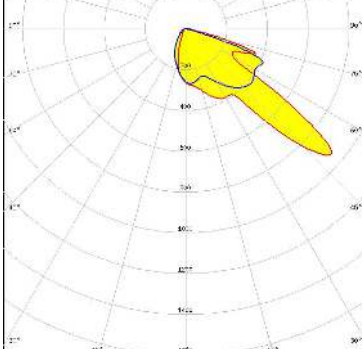
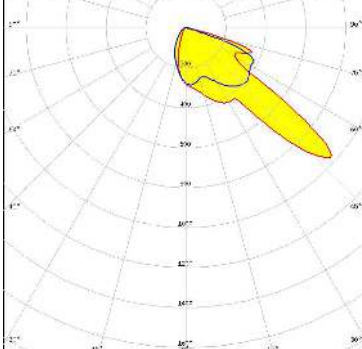
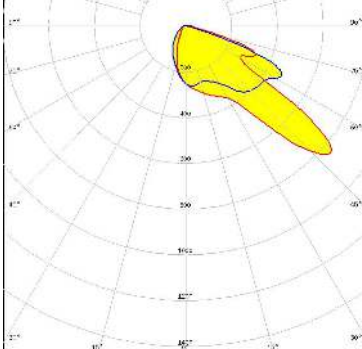
<p>SEOUL SEMICONDUCTOR</p> <p>LED Z5</p> <p>FWHM / FWTM Asymmetric</p> <p>Efficiency 94 %</p> <p>Peak intensity 1.3 cd/lm</p> <p>LEDs/each optic 1</p> <p>Light colour White</p> <p>Required components:</p>	 <p>Light on plane, note: 1° tilt rotation (down) center's.</p>	 <p>DECREASES BEAM DIVERGENCE</p> <p>BEAM DIAMETER</p>	
<p>SEOUL SEMICONDUCTOR</p> <p>LED Z5M</p> <p>FWHM / FWTM Asymmetric</p> <p>Efficiency 94 %</p> <p>Peak intensity 1 cd/lm</p> <p>LEDs/each optic 1</p> <p>Light colour White</p> <p>Required components:</p>	 <p>Light on plane, note: 1° tilt rotation (down) center's.</p>	 <p>DECREASES BEAM DIVERGENCE</p> <p>BEAM DIAMETER</p>	
<p>SEOUL SEMICONDUCTOR</p> <p>LED Z5M1/Z5M2</p> <p>FWHM / FWTM Asymmetric</p> <p>Efficiency 94 %</p> <p>Peak intensity 1 cd/lm</p> <p>LEDs/each optic 1</p> <p>Light colour White</p> <p>Required components:</p>			
<p>SEOUL SEMICONDUCTOR</p> <p>LED Z5M3</p> <p>FWHM / FWTM Asymmetric</p> <p>Efficiency 94 %</p> <p>Peak intensity 0.9 cd/lm</p> <p>LEDs/each optic 1</p> <p>Light colour White</p> <p>Required components:</p>			

OPTICAL RESULTS (MEASURED):

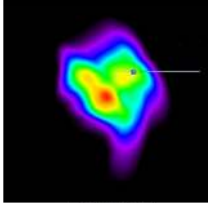
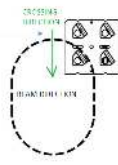
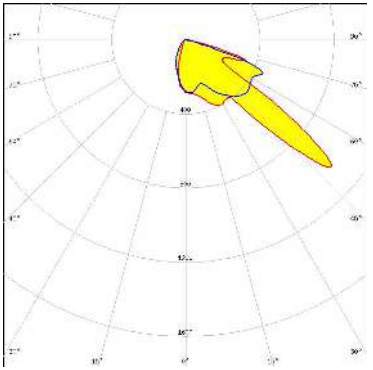
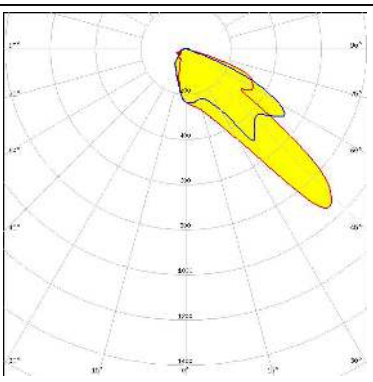
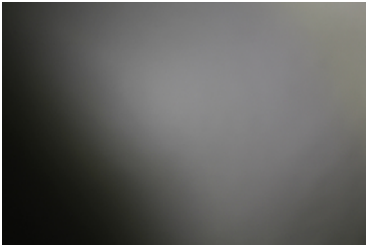
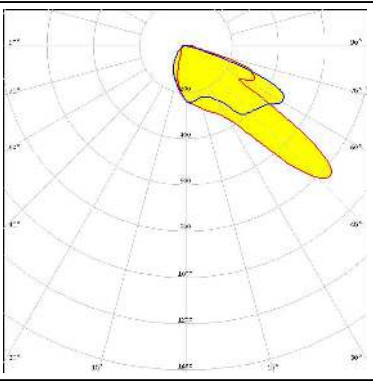
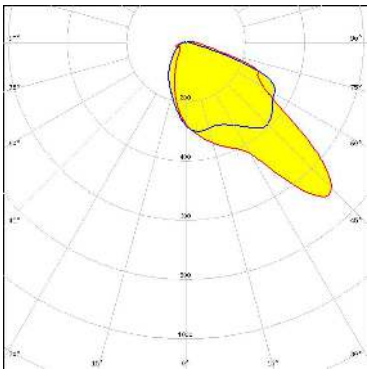
<p>SEOUL SEMICONDUCTOR</p> <p>LED Z5P</p> <p>FWHM / FWTM Asymmetric</p> <p>Efficiency 94 %</p> <p>Peak intensity 1.1 cd/lm</p> <p>LEDs/each optic 1</p> <p>Light colour White</p> <p>Required components:</p>	 <p>High on beam, high 1.1 cd/lm resolution (down to 0.1°)</p> 	
<p>SEOUL SEMICONDUCTOR</p> <p>LED Z8Y22</p> <p>FWHM / FWTM Asymmetric</p> <p>Efficiency 94 %</p> <p>Peak intensity 1 cd/lm</p> <p>LEDs/each optic 1</p> <p>Light colour White</p> <p>Required components:</p>		
<p>SEOUL SEMICONDUCTOR</p> <p>LED Z8Y22P</p> <p>FWHM / FWTM Asymmetric</p> <p>Efficiency 94 %</p> <p>Peak intensity 0.9 cd/lm</p> <p>LEDs/each optic 1</p> <p>Light colour White</p> <p>Required components:</p>		
<p>TOSHIBA Leading Innovation >>></p> <p>LED TL1L3</p> <p>FWHM / FWTM Asymmetric</p> <p>Efficiency 94 %</p> <p>Peak intensity 0.8 cd/lm</p> <p>LEDs/each optic 1</p> <p>Light colour White</p> <p>Required components:</p>		

OPTICAL RESULTS (MEASURED):

TOSHIBA

Leading Innovation >>

LED TL1L4
 FWHM / FWTM Asymmetric
 Efficiency 91 %
 Peak intensity 1 cd/lm
 LEDs/each optic 1
 Light colour White
 Required components:

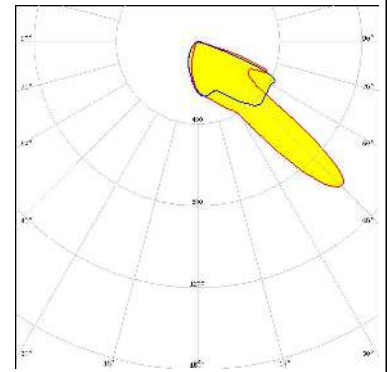

TRIDONIC

LED RLE 2x4 2000lm HP EXC2 OTD
 FWHM / FWTM Asymmetric
 Efficiency 94 %
 Peak intensity 1.2 cd/lm
 LEDs/each optic 1
 Light colour White
 Required components:

TRIDONIC

LED RLE 2x8 4000lm HP EXC2 OTD
 FWHM / FWTM Asymmetric
 Efficiency 94 %
 Peak intensity 1.2 cd/lm
 LEDs/each optic 1
 Light colour White
 Required components:

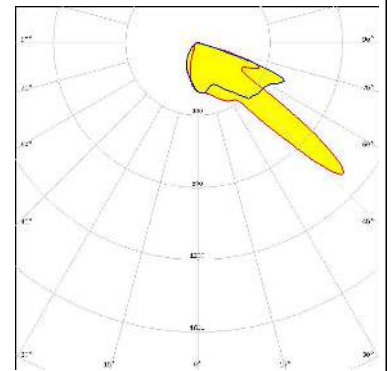

TRIDONIC

LED RLE G1 49x121mm 2000lm xxx EXC OTD
 FWHM / FWTM Asymmetric
 Efficiency 94 %
 Peak intensity 1.1 cd/lm
 LEDs/each optic 1
 Light colour White
 Required components:

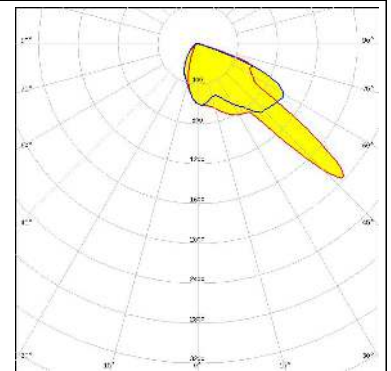

OPTICAL RESULTS (MEASURED):

TRIDONIC

LED RLE G1 49x133mm 2000lm xxx EXC OTD
FWHM / FWTM Asymmetric
Efficiency 94 %
Peak intensity 1.1 cd/lm
LEDs/each optic 1
Light colour White
Required components:

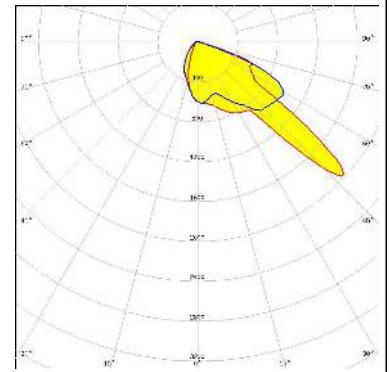

TRIDONIC

LED RLE G1 49x223mm 4000lm xxx EXC OTD
FWHM / FWTM Asymmetric
Efficiency 94 %
Peak intensity 1.1 cd/lm
LEDs/each optic 1
Light colour White
Required components:

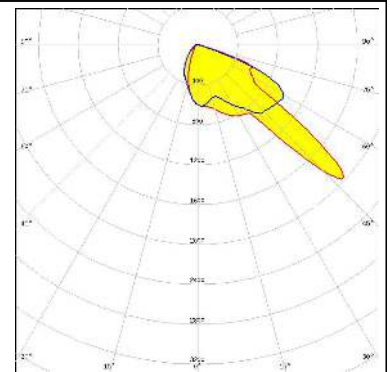

TRIDONIC

LED RLE G1 49x245mm 4000lm xxx EXC OTD
FWHM / FWTM Asymmetric
Efficiency 94 %
Peak intensity 1.1 cd/lm
LEDs/each optic 1
Light colour White
Required components:

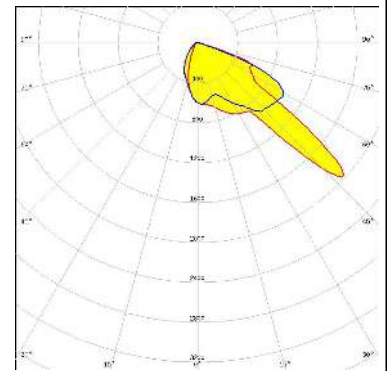

OPTICAL RESULTS (SIMULATED):

<p>CREE ⇄ LED</p> <p>LED: XD16 FWHM / FWTM: Asymmetric Efficiency: 94 % Peak intensity: 1 cd/lm LEDs/each optic: 2 Light colour: White Required components:</p>		
<p>CREE ⇄ LED</p> <p>LED: XE-G FWHM / FWTM: Asymmetric Efficiency: 94 % Peak intensity: 0.9 cd/lm LEDs/each optic: 2 Light colour: White Required components:</p>		
<p>CREE ⇄ LED</p> <p>LED: XP-G2 HE FWHM / FWTM: Asymmetric Efficiency: 93 % Peak intensity: 0.9 cd/lm LEDs/each optic: 1 Light colour: White Required components:</p>		
<p>CREE ⇄ LED</p> <p>LED: XP-G3 FWHM / FWTM: Asymmetric Efficiency: 81 % Peak intensity: 0.8 cd/lm LEDs/each optic: 1 Light colour: White Required components:</p> <p style="background-color: #e0f0ff; padding: 5px; display: inline-block;">Protective plate, glass</p>		

OPTICAL RESULTS (SIMULATED):

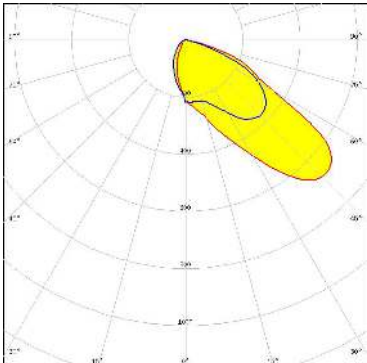
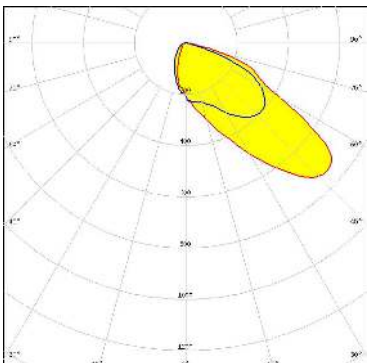
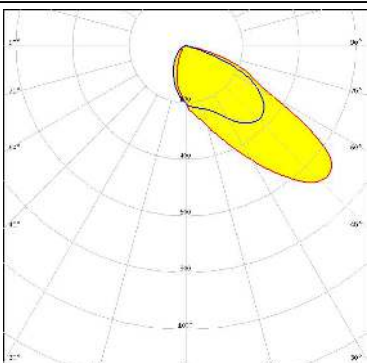
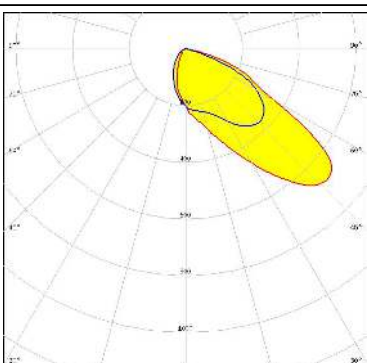
<p>LUMILEDS</p> <p>LED LUXEON 5050 Round LES</p> <p>FWHM / FWTM Asymmetric</p> <p>Efficiency 85 %</p> <p>Peak intensity 0.8 cd/lm</p> <p>LEDs/each optic 1</p> <p>Light colour White</p> <p>Required components:</p> <p>Protective plate, glass</p>	
<p>LUMILEDS</p> <p>LED LUXEON 5050 Square LES</p> <p>FWHM / FWTM Asymmetric</p> <p>Efficiency 96 %</p> <p>Peak intensity 0.8 cd/lm</p> <p>LEDs/each optic 1</p> <p>Light colour White</p> <p>Required components:</p>	
<p>LUMILEDS</p> <p>LED LUXEON 5050 Square LES</p> <p>FWHM / FWTM Asymmetric</p> <p>Efficiency 85 %</p> <p>Peak intensity 0.8 cd/lm</p> <p>LEDs/each optic 1</p> <p>Light colour White</p> <p>Required components:</p> <p>Protective plate, glass</p>	
<p>LUMILEDS</p> <p>LED LUXEON 5050 Square LES</p> <p>FWHM / FWTM Asymmetric</p> <p>Efficiency 85 %</p> <p>Peak intensity 0.8 cd/lm</p> <p>LEDs/each optic 1</p> <p>Light colour White</p> <p>Required components:</p> <p>Protective plate, glass</p>	

OPTICAL RESULTS (SIMULATED):

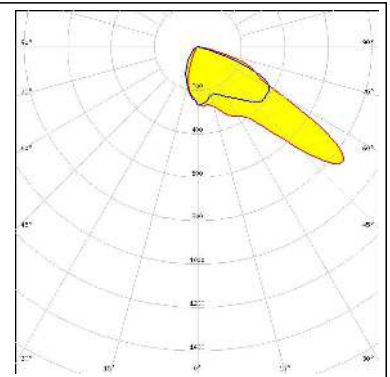
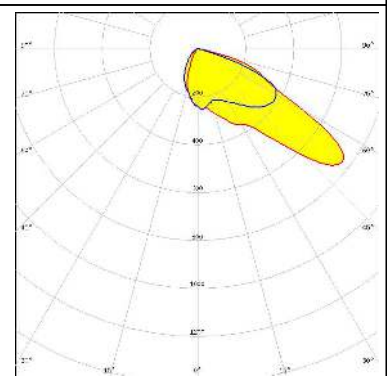
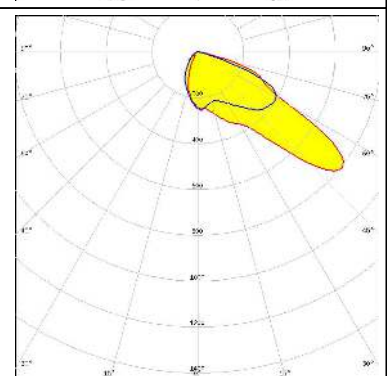
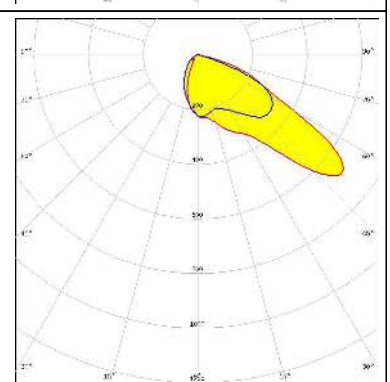
<p>LUMILEDS</p> <p>LED: LUXEON HL2X FWHM / FWTM: Asymmetric Efficiency: 93 % Peak intensity: 1 cd/lm LEDs/each optic: 1 Light colour: White Required components:</p>	
<p>LUMILEDS</p> <p>LED: LUXEON HL2X-P FWHM / FWTM: Asymmetric Efficiency: 94 % Peak intensity: 0.9 cd/lm LEDs/each optic: 1 Light colour: White Required components:</p>	
<p>LUMILEDS</p> <p>LED: LUXEON XR-HL2X (L2H2-xxxxxxxMLU010) FWHM / FWTM: Asymmetric Efficiency: 96 % Peak intensity: 0.9 cd/lm LEDs/each optic: 1 Light colour: White Required components:</p>	
<p>LUMILEDS</p> <p>LED: LUXEON XR-HL2X (L2H2-xxxxxxxMLU010) FWHM / FWTM: Asymmetric Efficiency: 83 % Peak intensity: 0.8 cd/lm LEDs/each optic: 1 Light colour: White Required components:</p> <p style="background-color: #ADD8E6; padding: 2px; display: inline-block;">Protective plate, glass</p>	

OPTICAL RESULTS (SIMULATED):

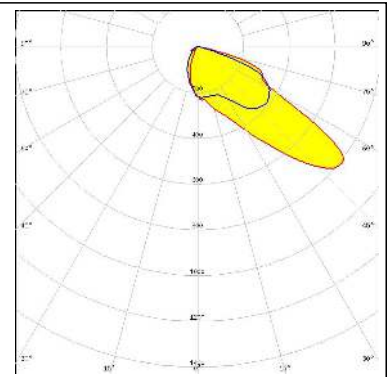
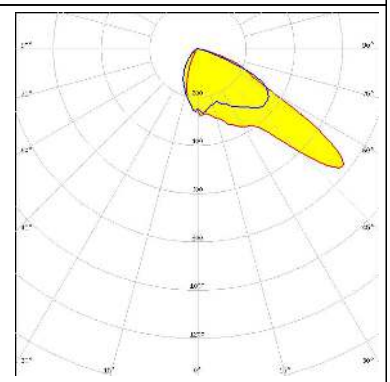
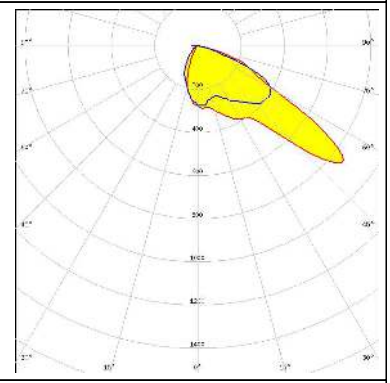
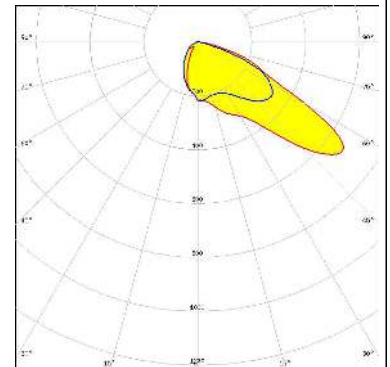
<p>NICHIA</p> <p>LED: NV4WB35AM FWHM / FWTM: Asymmetric Efficiency: 96 % Peak intensity: 0.9 cd/lm LEDs/each optic: 1 Light colour: White Required components:</p>	
<p>NICHIA</p> <p>LED: NVSW219D FWHM / FWTM: Asymmetric Efficiency: 84 % Peak intensity: 1.1 cd/lm LEDs/each optic: 1 Light colour: White Required components:</p> <p>Protective plate, glass</p>	
<p>NICHIA</p> <p>LED: NVSW219D FWHM / FWTM: Asymmetric Efficiency: 94 % Peak intensity: 1.1 cd/lm LEDs/each optic: 1 Light colour: White Required components:</p>	
<p>NICHIA</p> <p>LED: NVSW519A FWHM / FWTM: Asymmetric Efficiency: 86 % Peak intensity: 0.7 cd/lm LEDs/each optic: 1 Light colour: White Required components:</p> <p>Protective plate, glass</p>	

OPTICAL RESULTS (SIMULATED):

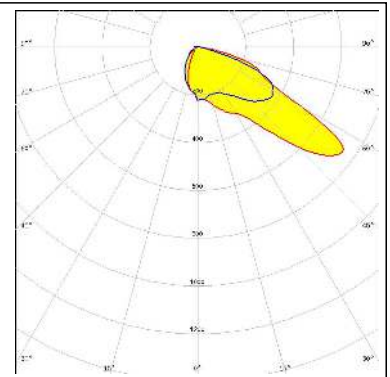
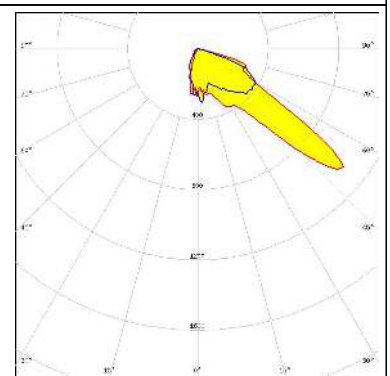
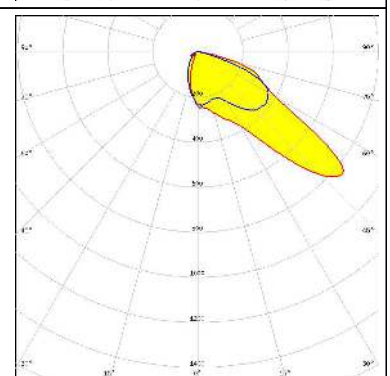
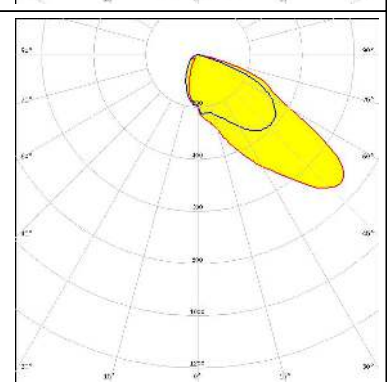
<p>NICHIA</p> <p>LED: NVSW519A FWHM / FWTM: Asymmetric Efficiency: 94 % Peak intensity: 0.8 cd/lm LEDs/each optic: 1 Light colour: White Required components:</p>	
<p>OSRAM</p> <p>LED: PrevaLED Brick HP 2x8 FWHM / FWTM: Asymmetric Efficiency: 92 % Peak intensity: 1.1 cd/lm LEDs/each optic: 1 Light colour: White Required components:</p>	
<p>OSRAM <small>Opto Semiconductors</small></p> <p>LED: OSCONIQ P 3737 (3W version) FWHM / FWTM: Asymmetric Efficiency: 94 % Peak intensity: 3.7 cd/lm LEDs/each optic: 1 Light colour: White Required components:</p>	
<p>OSRAM <small>Opto Semiconductors</small></p> <p>LED: OSCONIQ S 5050 FWHM / FWTM: Asymmetric Efficiency: 95 % Peak intensity: 0.8 cd/lm LEDs/each optic: 1 Light colour: White Required components:</p>	

OPTICAL RESULTS (SIMULATED):

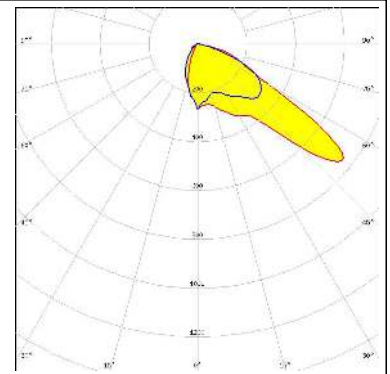
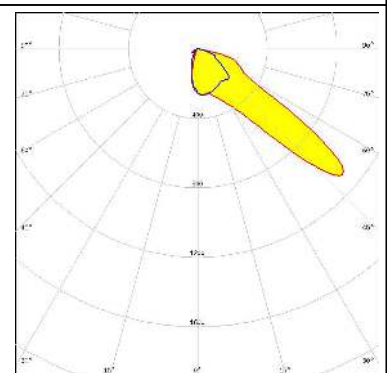
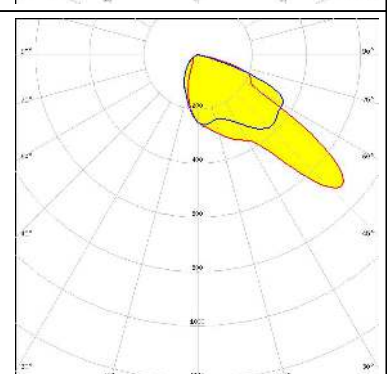
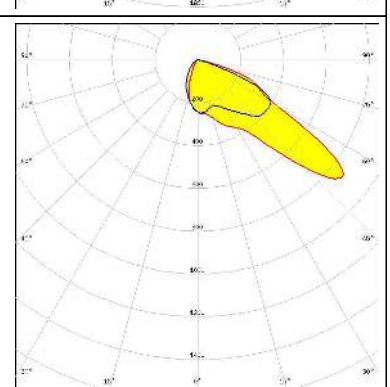
<p>OSRAM Opto Semiconductors</p> <p>LED: OSLOM Square CSSRM2/CSSRM3</p> <p>FWHM / FWTM: Asymmetric</p> <p>Efficiency: 80 %</p> <p>Peak intensity: 0.9 cd/lm</p> <p>LEDs/each optic: 1</p> <p>Light colour: White</p> <p>Required components:</p> <p>Protective plate, glass</p>	
<p>OSRAM Opto Semiconductors</p> <p>LED: OSLOM Square CSSRM2/CSSRM3</p> <p>FWHM / FWTM: Asymmetric</p> <p>Efficiency: 95 %</p> <p>Peak intensity: 1.2 cd/lm</p> <p>LEDs/each optic: 1</p> <p>Light colour: White</p> <p>Required components:</p>	
<p>SAMSUNG</p> <p>LED: LH351B</p> <p>FWHM / FWTM: Asymmetric</p> <p>Efficiency: 85 %</p> <p>Peak intensity: 0.8 cd/lm</p> <p>LEDs/each optic: 1</p> <p>Light colour: White</p> <p>Required components:</p> <p>Protective plate, glass</p>	
<p>SAMSUNG</p> <p>LED: LH351C</p> <p>FWHM / FWTM: Asymmetric</p> <p>Efficiency: 94 %</p> <p>Peak intensity: 1 cd/lm</p> <p>LEDs/each optic: 1</p> <p>Light colour: White</p> <p>Required components:</p>	

OPTICAL RESULTS (SIMULATED):

SAMSUNG

LED LH351C
 FWHM / FWTM Asymmetric
 Efficiency 85 %
 Peak intensity 0.9 cd/lm
 LEDs/each optic 1
 Light colour White
 Required components:

Protective plate, glass

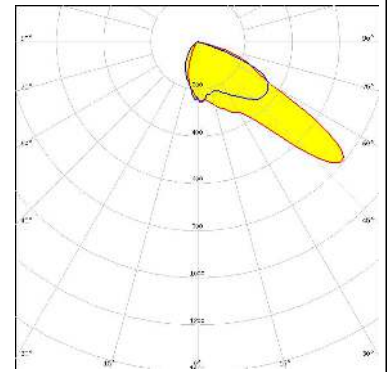

SAMSUNG

LED LH351D
 FWHM / FWTM Asymmetric
 Efficiency 92 %
 Peak intensity 0.8 cd/lm
 LEDs/each optic 1
 Light colour White
 Required components:

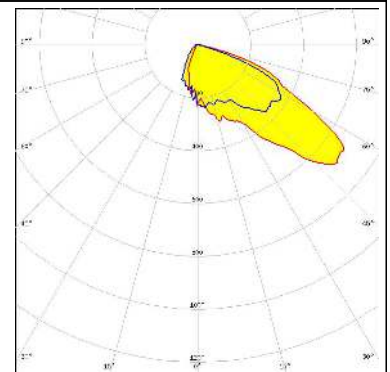

LED MJT 5050
 FWHM / FWTM Asymmetric
 Efficiency 95 %
 Peak intensity 0.8 cd/lm
 LEDs/each optic 1
 Light colour White
 Required components:

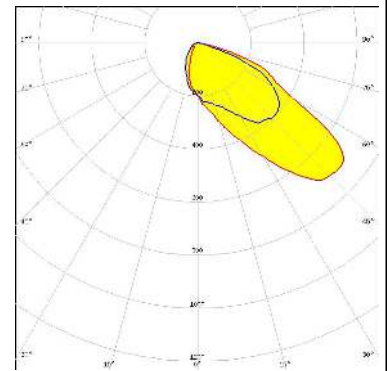

GENERAL INFORMATION:

NOTE: The typical beam angle will be changed by different color, chip size and chip position tolerance. The typical total beam angle is the full angle measured where the luminous intensity is half of the peak value.

MATERIALS:

As part of our continuous research and improvement processes, and to ensure the best possible quality and availability of our products, LEDiL reserves the right to change material grades without notice.

PRODUCT DATA USER AGREEMENT AND DISCLAIMER:

The measured data in the provided downloadable LEDiL Product Datasheets and Mechanical 2D-Drawings is rounded and provided as reference for planning. LEDiL Oy's optical specifications have been verified by conducting performance testing of the products in accordance with the company's quality system. The reported data are averaged results of multiple measurements with typical variation. LEDiL Oy reserves the right to without prior notification make changes and improvements to its products.

LEDiL Oy assumes neither warranty, nor guarantee nor any other liability of any kind for the contents and correctness of the provided data. The provided data has been generated with highest diligence but the provided data may in reality not represent the complete possible variation range of all intrinsic parameters. Therefore, in certain cases a deviation from the provided data could occur.

LEDiL Oy reserves the right to undertake technical changes of its products without further notification which could lead to changes in the provided data. LEDiL Oy assumes no liability of any kind for the possible deviation from any provided data or any other damage resulting from the usage of the provided data.

The user agrees to this disclaimer and user agreement with the download or usage of the provided files.

LEDiL Oy

Joensuunkatu 13
FI-24240 SALO
Finland

LEDiL Inc.

228 West Page Street
Suite D
Sycamore IL 60178
USA

Ledil Optics Technology (Shenzhen) Co., Ltd.

405 , Block B
Casic Motor Building
Shenzhen 518057
P.R.CHINA

Local sales and technical support

[www.ledil.com/
where_to_buy](http://www.ledil.com/where_to_buy)

Shipping locations

Salo, Finland
Hong Kong, China

Distribution Partners

[www.ledil.com/
where_to_buy](http://www.ledil.com/where_to_buy)