

Powerex, Inc., 200 Hillis Street, Youngwood, Pennsylvania 15697-1800 (412) 925-7272
 Powerex, Europe, S.A. 428 Avenue G. Durand, BP107, 72003 Le Mans, France (43) 41.14.14

Phase Control SCR
 2300 Amperes Average
 2500 Volts

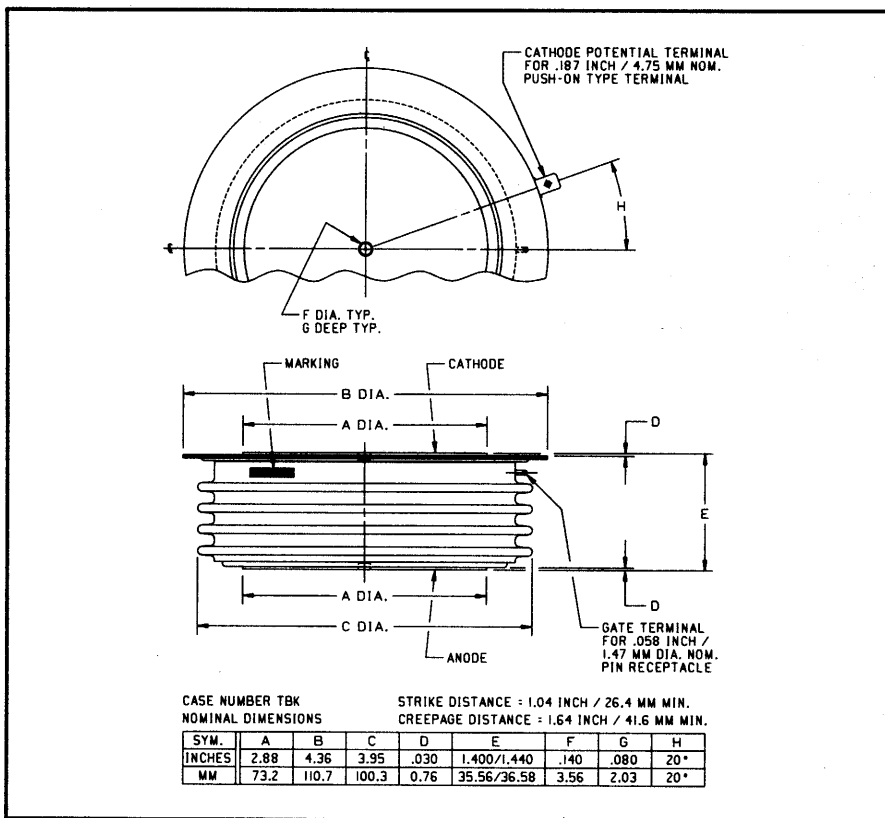

C782 (Outline Drawing)



C782 Phase Control SCR
 2300 Amperes Average, 2500 Volts

Description:

Powerex Silicon Controlled Rectifiers (SCR) are designed for phase control applications. These are all-diffused, Press-Pak, hermetic Pow-R-Disc devices employing the field proven amplifying gate.

Features:

- Low On-State Voltage
- High di/dt Capability
- High dv/dt Capability
- Hermetic Packaging
- Excellent Surge and I^2t Ratings

Applications:

- Power Supplies
- Motor Control

Ordering Information:

Select the complete six digit part number you desire from the table, i.e. C782LE is a 2500 Volt, 2300 Ampere Phase Control SCR.

Type	Voltage		Current
	V_{DRM}	Code	$I_{T(av)}$
C782	2200	LB	2300
	2300	LC	
	2400	LD	
	2500	LE	



Powerex, Inc., 200 Hillis Street, Youngwood, Pennsylvania 15697-1800 (412) 925-7272
 Powerex, Europe, S.A. 428 Avenue G. Durand, BP107, 72003 Le Mans, France (43) 41.14.14

C782
Phase Control SCR
 2300 Amperes Average, 2500 Volts

Absolute Maximum Ratings

Characteristics	Symbol	C782	Units
Non-repetitive Transient Peak Reverse Voltage	V_{RSM}	$V_{RRM} + 100V$	Volts
RMS On-state Current, $T_C = 70^\circ C$	$I_{T(rms)}$	3610	Amperes
Average Current 180° Sine Wave, $T_C = 70^\circ C$	$I_{T(av)}$	2300	Amperes
RMS On-state Current, $T_C = 55^\circ C$	$I_{T(rms)}$	4240	Amperes
Average Current 180° Sine Wave, $T_C = 55^\circ C$	$I_{T(av)}$	2700	Amperes
Peak One Cycle Surge On-state Current (Non-repetitive) 60Hz	I_{tsm}	35000	Amperes
Peak One Cycle Surge On-state Current (Non-repetitive) 50Hz	I_{tsm}	32000	Amperes
Critical Rate-of-rise of On-state Current (Non-repetitive)	di/dt	600	A/ μ sec
Critical Rate-of-rise of On-state Current (Repetitive)	di/dt	100	A/ μ sec
I^2t (for Fusing) for One Cycle, 60Hz	I^2t	5×10^6	A^2 sec
Peak Gate Power Dissipation	P_{GM}	250	Watts
Average Gate Power Dissipation	$P_{G(av)}$	35	Watts
Operating Temperature	T_j	-40 to +125°C	°C
Storage Temperature	T_{stg}	-40 to +150°C	°C
Approximate Weight		3.5	lb.
		1.60	kg
Mounting Force		9000 to 10000	lb.
		40 to 44.5	kN

C782

Phase Control SCR

2300 Amperes Average, 2500 Volts

Electrical Characteristics, $T_j = 25^\circ\text{C}$ Unless Otherwise Specified

Characteristics	Symbol	Test Conditions	Min.	Typ.	Max.	Units
Repetitive Peak Reverse Leakage Current	I_{RRM}	$T_j = 125^\circ\text{C}, V_R = V_{RRM}$			150	mA
Repetitive Peak Forward Leakage Current	I_{DRM}	$T_j = 125^\circ\text{C}, V_D = V_{DRM}$			150	mA
Peak On-state Voltage	V_{TM}	$T_j = 125^\circ\text{C}, I_T = 2000\text{A Peak}$ Duty Cycle < 0.1%			1.35	Volts
Threshold Voltage, Low-level	$V_{(TO)1}$	$T_j = 125^\circ\text{C}, I = 15\%, I_{T(av)}$ to $\pi I_{T(av)}$			0.86799	Volts
Slope Resistance, Low-level	r_{T1}				0.1703	m Ω
Threshold Voltage, High-level	$V_{(TO)2}$	$T_j = 125^\circ\text{C}, I = \pi I_{T(av)}$ to I_{TSM}			1.0951	Volts
Slope Resistance, High-level	r_{T2}				0.1226	m Ω
V_{TM} Coefficients, Low-level		$T_j = 125^\circ\text{C}, I = 15\% I_{T(av)}$ to $\pi I_{T(av)}$				$A_1 = 0.60452$ $B_1 = 0.003408$ $C_1 = 3.235E-05$ $D_1 = 0.01293$
V_{TM} Coefficients, High-level		$T_j = 125^\circ\text{C}, I = \pi I_{T(av)}$ to I_{TSM}				$A_2 = 2.2748$ $B_2 = -0.17012$ $C_2 = 1.155E-04$ $D_2 = 0.004534$
Typical Delay Time	t_d	$T_j = 125^\circ\text{C}, V_D = 1800\text{V}$		3		μsec
Typical Turn-off Time	t_q	$T_j = 125^\circ\text{C}, I_T = 2000\text{A},$ $t_p > 2\text{msec}, di_R/dt = 5\text{A}/\mu\text{sec}$ V Reapplied = 1500V, $dv/dt = 1000\text{V}/\mu\text{sec}, V_R = 100\text{V}$		250		μsec
Minimum Critical dv/dt - Exponential to V_{DRM}	dv/dt	$T_j = 125^\circ\text{C}, V_D = 0.8 V_{DRM}$	500			V/ μsec
Gate Trigger Current	I_{GT}	$T_j = 25^\circ\text{C}, V_D = 12\text{V}_{DC}$			250	mA
Gate Trigger Voltage	V_{GT}	$T_j = 25^\circ\text{C}, V_D = 12\text{V}_{DC}$			4.5	Volts
Non-Trigging Gate Voltage	V_{GDM}	$T_j = 125^\circ\text{C}, V_D = 1300\text{V}$			0.5	Volts
Peak Forward Gate Current	I_{GTM}				20	A
Peak Reverse Gate Voltage	V_{GRM}				20	Volts

Thermal Characteristics

Maximum Thermal Resistance, Double Sided Cooling

Junction-to-Case	$R_{\theta(j-c)}$		0.012	$^\circ\text{C}/\text{W}$
Case-to-Sink	$R_{\theta(c-s)}$		0.002	$^\circ\text{C}/\text{W}$

Powerex, Inc., 200 Hillis Street, Youngwood, Pennsylvania 15697-1800 (412) 925-7272
 Powerex, Europe, S.A. 428 Avenue G. Durand, BP107, 72003 Le Mans, France (43) 41.14.14

C782
Phase Control SCR
 2300 Amperes Average, 2500 Volts

Maximum On-State Forward Voltage Drop
 ($T_J = 125^\circ\text{C}$)

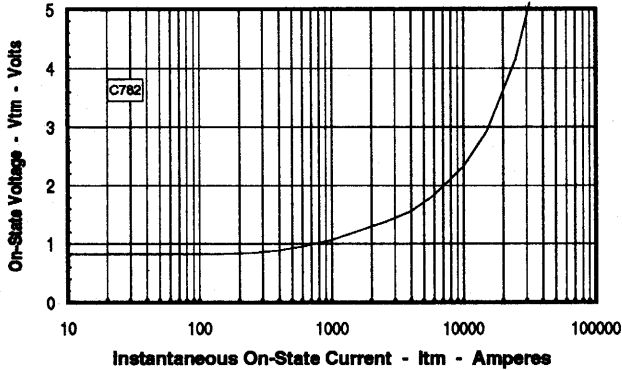

Maximum Transient Thermal Impedance
 (Junction to Case)

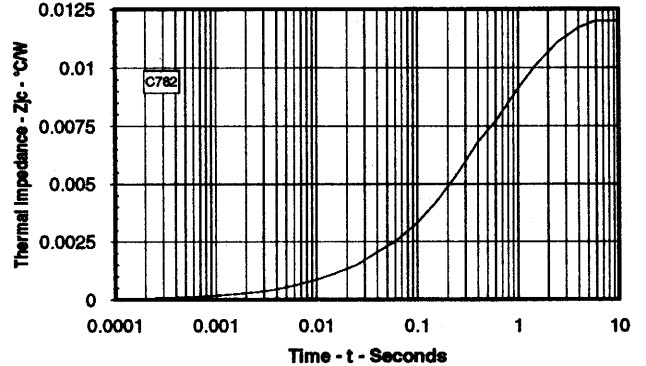

Maximum On-State Power Dissipation
 (Sinusoidal Waveform)

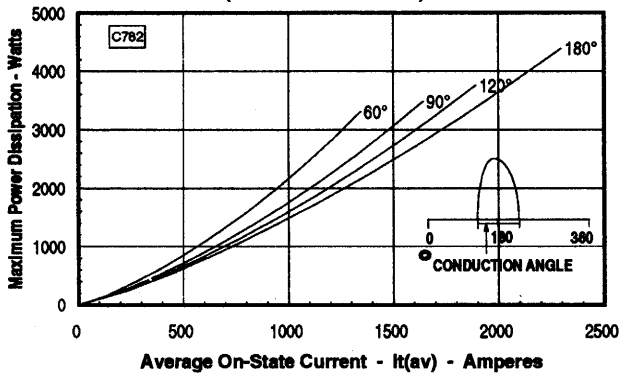

Maximum Allowable Case Temperature
 (Sinusoidal Waveform)

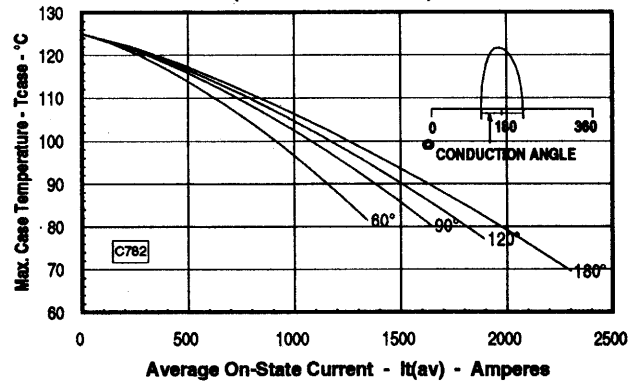

Maximum On-State Power Dissipation
 (Rectangular Waveform)

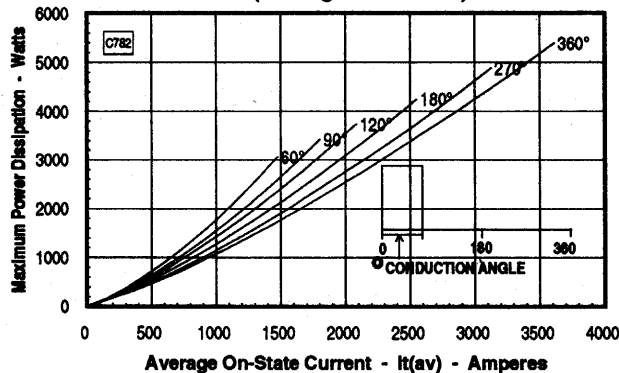

Maximum Allowable Case Temperature
 (Rectangular Waveform)

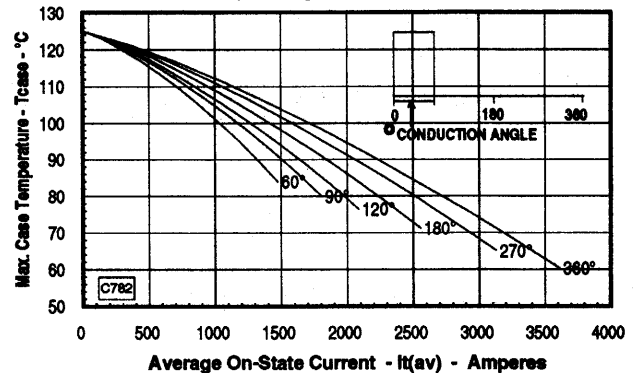

Note: Spreading losses included. Curves are for an inductive load.