

CDBHA1545-HF

Reverse Voltage: 45V

Forward Current: 15A

RoHS Device

Halogen Free



Features

- Metal silicon junction, majority carrier conduction.
- High surge capability.
- High temperature soldering guaranteed: 260°C/10 seconds.
- High current capability, low forward voltage drop.

Mechanical data

- Case: TO-277B, molded plastic.
- Epoxy: UL flammability classification rating 94V-0.
- Terminals: Solder plated, solderable per MIL-STD-202, method 208.

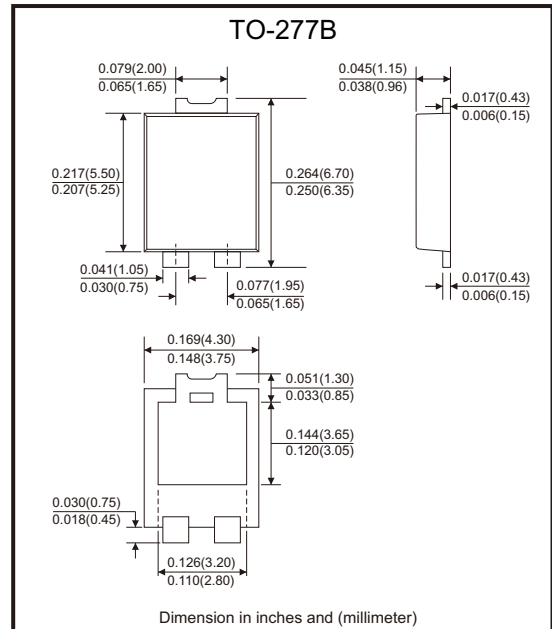

Circuit Diagram

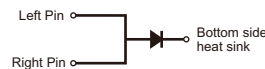

Maximum Ratings (at TA=25°C, unless otherwise noted)

Parameter	Symbol	Value	Unit
Peak repetitive reverse voltage	V_{RRM}	45	V
RMS reverse voltage	V_{RMS}	31.5	V
DC blocking voltage	V_{DC}	45	V
Maximum average forward output current	$I_{F(AV)}$	15	A
Peak forward surge current, 8.3ms single half sine-wave	I_{FSM}	250	A
Typical thermal resistance (Note 1)	$R_{\theta JA}$	60	°C/W
	$R_{\theta JC}$	20	
	$R_{\theta JL}$	15	
Operating junction temperature range	T_J	-55 ~ +150	°C
Storage temperature range	T_{STG}	-55 ~ +150	°C

Notes: 1. Device mounted on PCB with 10mm x 20mm x 0.1mm copper pad areas.

Electrical Characteristics (at TA=25°C, unless otherwise noted)

Parameter	Conditions	Symbol	Min.	Typ.	Max.	Unit
Max. instantaneous forward voltage (Note 1)	$I_F = 15A$, @ $T_A = 25^\circ C$	V_F			0.47	V
Maximum reverse current (Note 2)	Rated V_R , @ $T_J = 25^\circ C$ @ $T_J = 100^\circ C$	I_R			500	μA
					40	mA

Notes: 1. Pulse test: 300 μs pulse width, 1% duty cycle.
2. Pulse test: pulse width 40ms.

Company reserves the right to improve product design, functions and reliability without notice.

REV:A

Rating and Characteristics Curves (CDBHA1545-HF)

Fig.1 - Forward Current Derating Curve

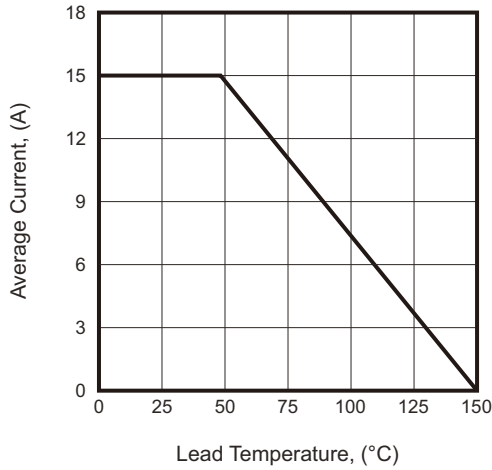

Fig.2 - Surge Current Derating Curve

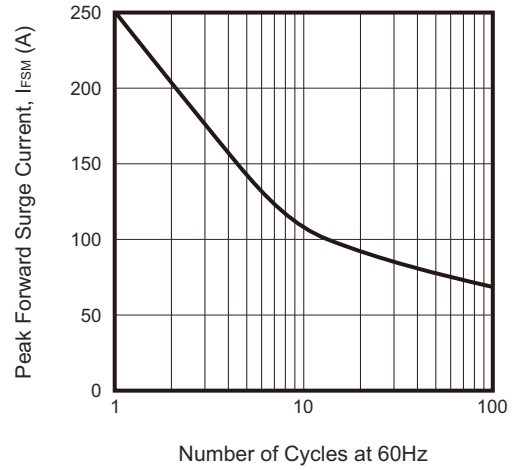

Fig.3 - Typical Forward Voltage Characteristics

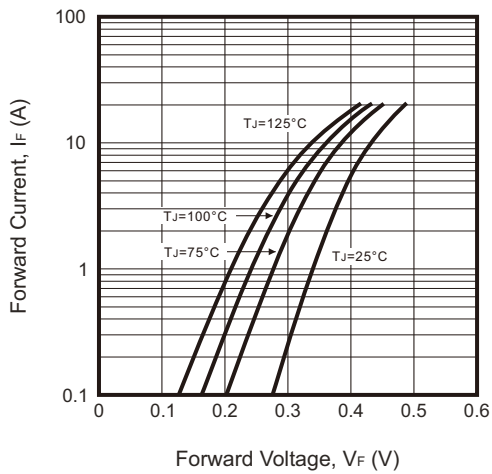
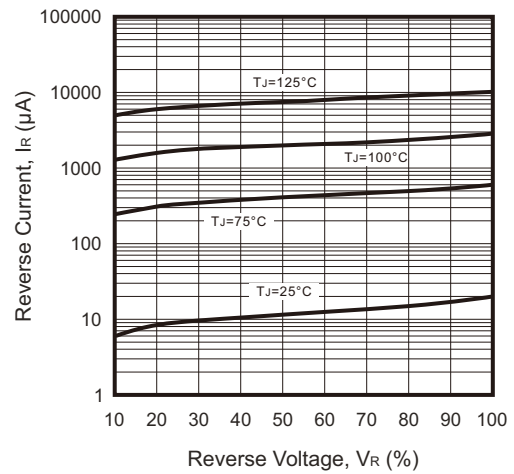
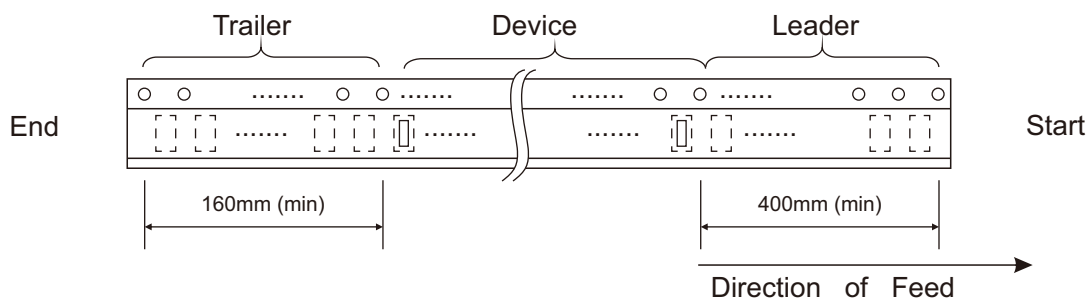
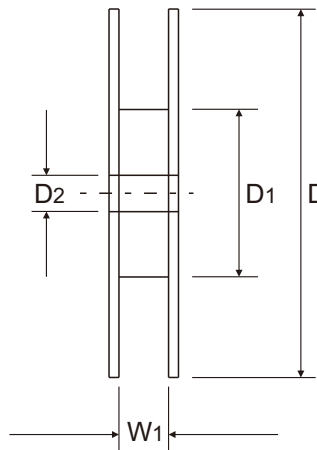
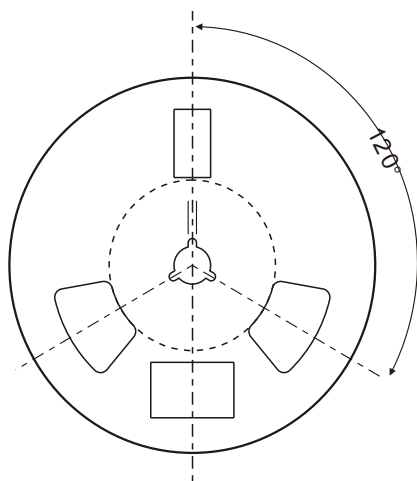
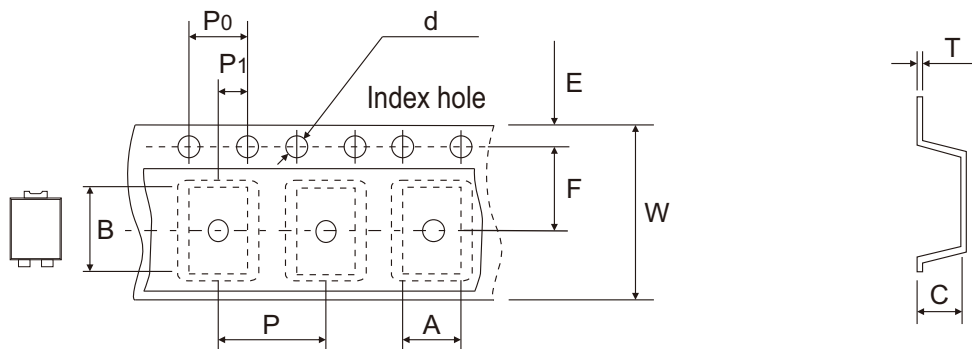

Fig.4 - Typical Reverse Characteristics



Reel Taping Specification



TO-277B	SYMBOL	A	B	C	d	D	D1	D2
	(mm)	4.30 ± 0.10	6.80 ± 0.10	1.50 ± 0.10	1.55 ± 0.10	330 ± 1.00	75.00 ± 1.00	13.50 ± 0.50
	(inch)	0.169 ± 0.004	0.268 ± 0.004	0.059 ± 0.004	0.061 ± 0.004	12.992 ± 0.039	2.953 ± 0.039	0.531 ± 0.020

TO-277B	SYMBOL	E	F	P	P0	P1	T	W	W1
	(mm)	1.75 ± 0.10	5.50 ± 0.10	8.00 ± 0.10	4.00 ± 0.10	2.00 ± 0.10	0.23 ± 0.05	12.00 ± 0.10	17.00 ± 1.00
	(inch)	0.069 ± 0.004	0.217 ± 0.004	0.315 ± 0.004	0.157 ± 0.004	0.079 ± 0.004	0.009 ± 0.002	0.472 ± 0.004	0.669 ± 0.039

Company reserves the right to improve product design, functions and reliability without notice. REV:A

Marking Code

Part Number	Marking Code
CDBHA1545-HF	D15S45L

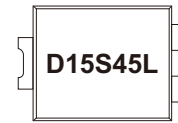

Suggested PAD Layout

SIZE	TO-277B	
	(mm)	(inch)
A	4.20	0.165
B	4.70	0.185
C	1.27	0.050
D	1.00	0.039
E	6.60	0.260
F	0.90	0.035

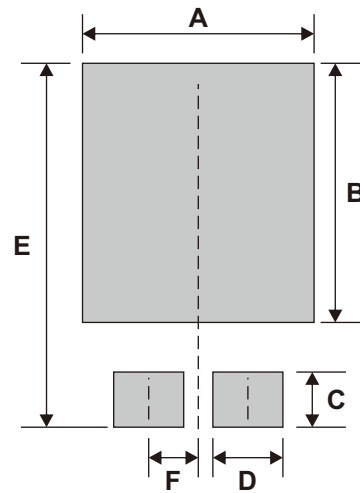

Note: 1. The pad layout is for reference purpose only.

Standard Packaging

Case Type	REEL PACK	
	REEL (pcs)	Reel Size (inch)
TO-277B	4,000	13