

1-141708-2 ✓ ACTIVE

AMPMODU | AMPMODU IV/V

TE Internal #: 1-141708-2

Connector Contact, Receptacle, Wire-to-Board, 30 – 26 AWG Wire Size, 100 – 254 CMA Wire Size, .05 – .12 mm² Wire Size, Gold, Bag, AMPMODU IV/V

[View on TE.com >](#)



Connectors > PCB Connectors > Wire-to-Board Connectors > Wire-to-Board Connector Contacts

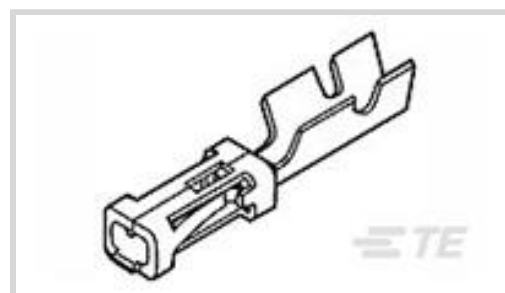

Contact Type: **Receptacle**

Connector System: **Wire-to-Board**

Wire Size: **.05 – .12 mm²**

Features

Product Type Features

Applied Pressure	Intermediate
Connector System	Wire-to-Board
Connector & Contact Terminates To	Wire & Cable

Configuration Features

Compatible With Wire & Cable Type	Discrete Wire
-----------------------------------	---------------

Contact Features

Mating Square Post Dimension	.64 mm[.025 in]
Contact Retention Within Housing	With
Wire Contact Termination Area Plating Material	Tin
	30 μin
Contact Orientation	Straight
Contact Base Material	Phosphor Bronze
Contact Type	Receptacle
Contact Mating Area Plating Material	Gold
Contact Current Rating (Max)	4.4 A

Termination Features

Termination Method to Wire & Cable	Crimp
------------------------------------	-------

Mechanical Attachment

Contact Retention Type Within Housing	Locking Lance
---------------------------------------	---------------



Wire Insulation Support With

Dimensions

Compatible Insulation Diameter Range	1.21 mm[.048 in]
Wire Size	.05 – .12 mm ²

Usage Conditions

Operating Temperature Range	-65 – 105 °C[-85 – 221 °F]
-----------------------------	----------------------------

Operation/Application

Circuit Application	Signal
---------------------	--------

Packaging Features

Packaging Quantity	200
Packaging Method	Bag

Other

Connector Contacts Comment	For 0.63 mm "Round" Post and 0.63 x 0.63 mm "Square" Post., Reduced crimp width at 0.14 mm ² -. Please contact AMP.
----------------------------	--

Product Compliance

[For compliance documentation, visit the product page on TE.com>](#)

EU RoHS Directive 2011/65/EU	Compliant
EU ELV Directive 2000/53/EC	Compliant
China RoHS 2 Directive MIIT Order No 32, 2016	No Restricted Materials Above Threshold
EU REACH Regulation (EC) No. 1907/2006	Current ECHA Candidate List: JUNE 2023 (235) Candidate List Declared Against: JAN 2023 (233) Does not contain REACH SVHC
Halogen Content	Low Halogen - Br, Cl, F, I < 900 ppm per homogenous material. Also BFR/CFR/PVC Free
Solder Process Capability	Not applicable for solder process capability

Product Compliance Disclaimer

This information is provided based on reasonable inquiry of our suppliers and represents our current actual knowledge based on the information they provided. This information is subject to change. The part numbers that TE has identified as EU RoHS compliant have a maximum concentration of 0.1% by weight in homogenous materials for lead, hexavalent chromium, mercury, PBB, PBDE, DBP, BBP, DEHP, DIBP, and 0.01% for cadmium, or qualify for an exemption to these limits as defined in the Annexes of Directive 2011/65/EU (RoHS2). Finished electrical and electronic equipment products will be CE marked as required by Directive 2011/65/EU. Components may not be CE marked. Additionally, the part numbers that TE has identified as EU ELV compliant have a maximum concentration of 0.1% by weight in homogenous

materials for lead, hexavalent chromium, and mercury, and 0.01% for cadmium, or qualify for an exemption to these limits as defined in the Annexes of Directive 2000/53/EC (ELV). Regarding the REACH Regulation, the information TE provides on SVHC in articles for this part number is based on the latest European Chemicals Agency (ECHA) 'Guidance on requirements for substances in articles' posted at this URL: <https://echa.europa.eu/guidance-documents/guidance-on-reach>

Compatible Parts



Also in the Series | AMPMODU IV/V

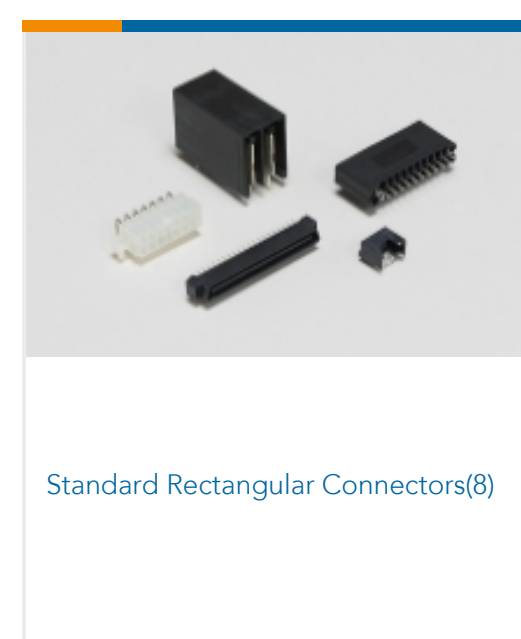
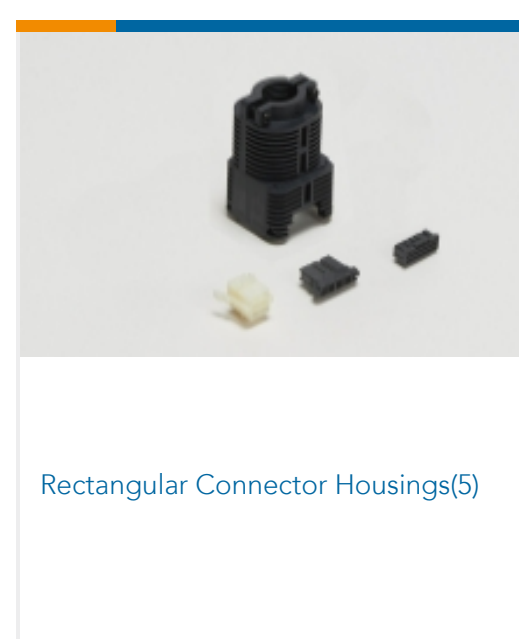
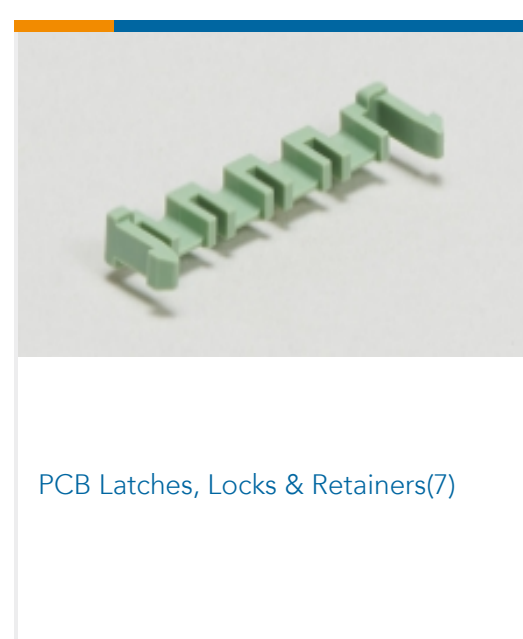
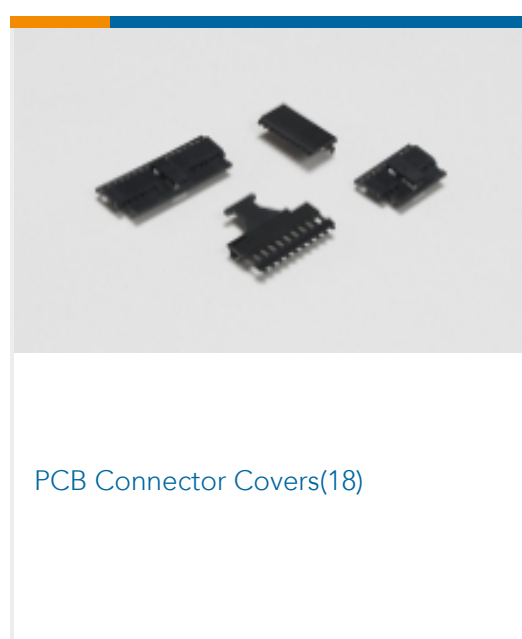
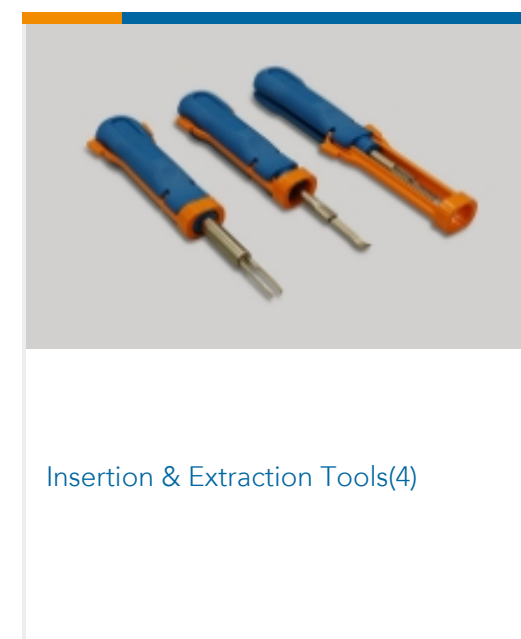
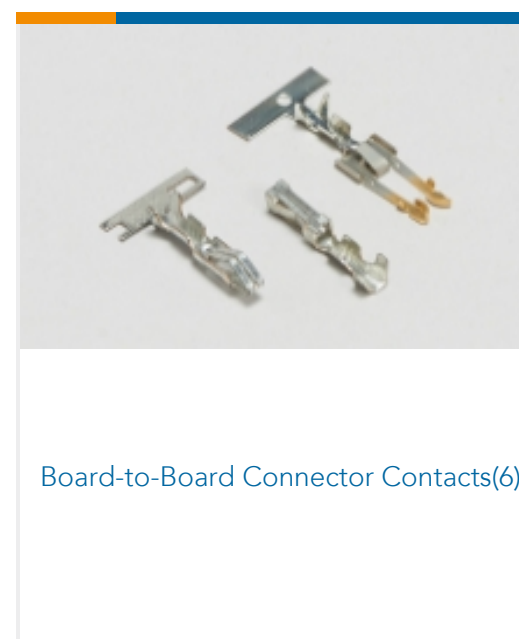
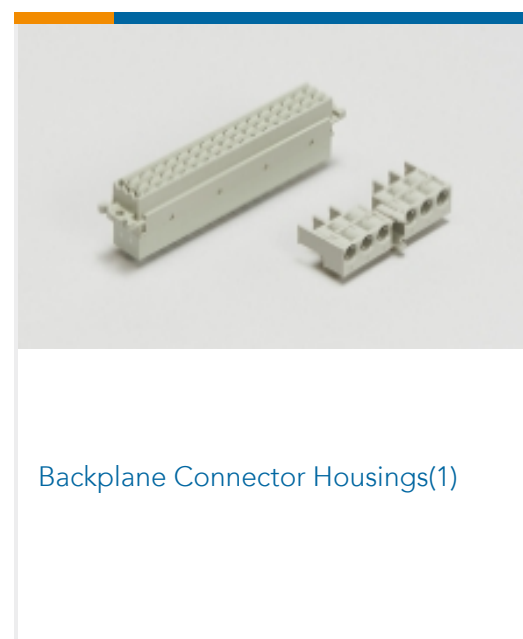
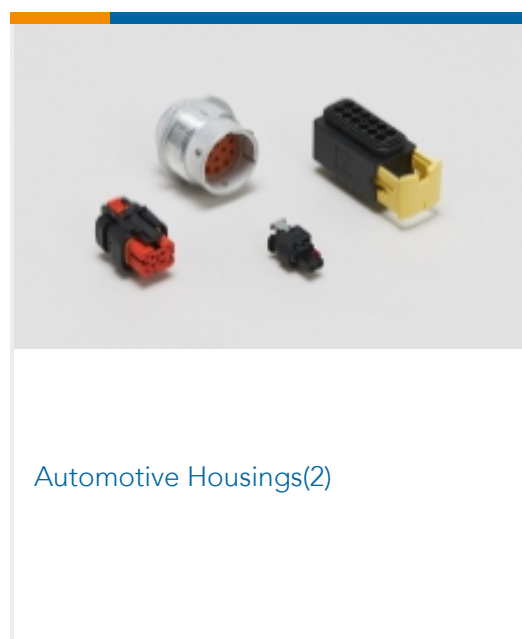

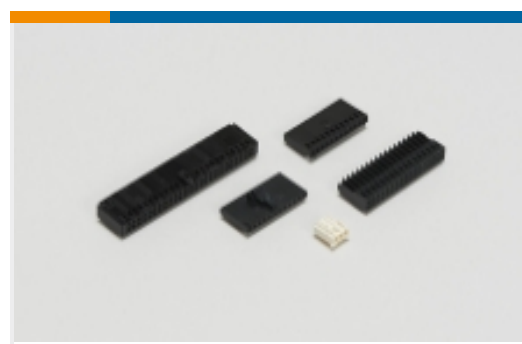
Wire-to-Board Connector Assemblies
& Housings(465)Wire-to-Board Connector Contacts
(325)

Customers Also Bought

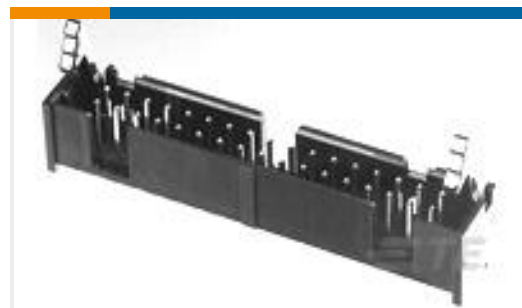
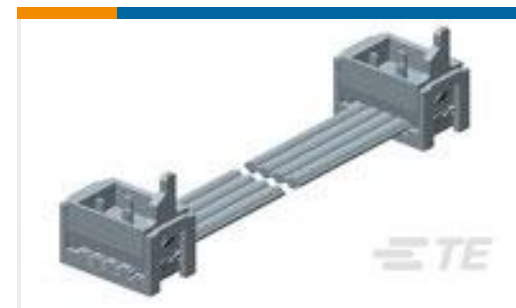
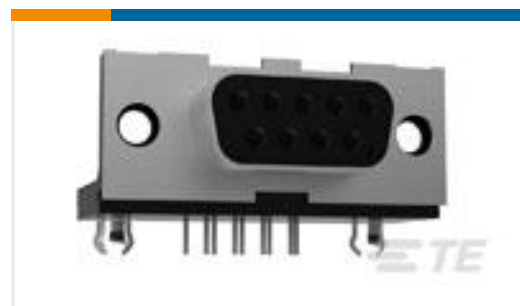
TE Part #2-1761608-7
IDC LOW PRO HDR 20P VERT SHT LTE Part #826469-6
2X6P MOD II SHROUDED HEADER, STTE Part #3-2176400-1
3540 18R 1%TE Part #2205061-2
CA MICRO-MATCH MOW-MOW
6POSTE Part #1859304003
RNF-3000-6/2-7-SPTE Part #5-106507-2
25P.HDP20 REC.ASSYTE Part #826470-6
2X6P MOD II SHROUDED HEADER,
RT ANG.TE Part #1393230-5
RP3SLF12TE Part #926476-5
MOD 4 HSGTE Part #5-826662-0
50P AMPMODU II STIFT LEI

Documents

Product Drawings

[MOD-4 REC.CONT.SCP.](#)

English

CAD Files

Customer View Model

[ENG_CVM_CVM_1-141708-2_G.2d_dxf.zip](#)

English

[3D PDF](#)



3D

Customer View Model

[ENG_CVM_CVM_1-141708-2_G.3d_igs.zip](#)

English

Customer View Model

[ENG_CVM_CVM_1-141708-2_G.3d_stp.zip](#)

English

By downloading the CAD file I accept and agree to the [Terms and Conditions](#) of use.

Product Environmental Compliance

[TE Material Declaration](#)

English