

24 x 48 Hour counters CHM24 Part number 99782716



- VAC : capacity 100,000 hrs (99,999.99 hrs)
- VDC : capacity 1,000,000 hrs (999,999.99 hrs)
- Operation indicator
- Panel mounted
- IP65 (with accessory 26546847)
- Highly resistant to shocks and impacts
- Compact size
- Excellent visibility due to the large digit size

Part numbers

	Type	Operating frequency (Hz)	Voltages
99782716	CHM24	60	187 →264 VAC

Specifications

General characteristics

Counting capacity	VAC : 99,999.99 VDC : 999,999.99
Reset to zero	Not included
Read accuracy	1/100 h
Height digits (mm)	4
Colour of hour numbers	White on a black background
Colour of decimal digits	Red on a black background
Accuracy	VAC : frequency + 30 ms VDC : < 0.003 % (24 hrs)
Counting input mode	Addition
Operation indicator	VAC : rotating red lines/DC : 1/100 hr 1 digit in 36 s
Protection rating	IP52 or IP65 with accessory (26546847)
Mounting position	Any
Temperature limits use (°C)	-10 →+50
Temperature limits stored (°C)	-40 →+80
Certifications	CE - UL (pending)
Connections (panel mounted version)	Screw terminals - 6.35 mm Faston connectors
Tightening torque (Nm)	0,8
Connection capacity	2,5 mm ²
Consumption	VDC : 10 →30 approx. 500 mW/100 →130 approx. 750 mW/ VAC 50 Hz : 20 →30 approx. 0.3 VA/100 →130 approx. 0.6 VA/187 →264 approx. 1.2 VA
Vibration resistance	50 m/s ² (10-500 Hz) IEC 68-2-6
Test voltage for AC models	2 000 VAC 50 Hz
Weight (g)	50

Accessories

Description	Code
Set of seals	26546847
Adaptor for 50 x 25 mm cut-out - Fixed with screws	26546843
Adaptor for 50 x 25 mm cut-out - Fixed with clips	26546844

Dimensions (mm)

CHM24

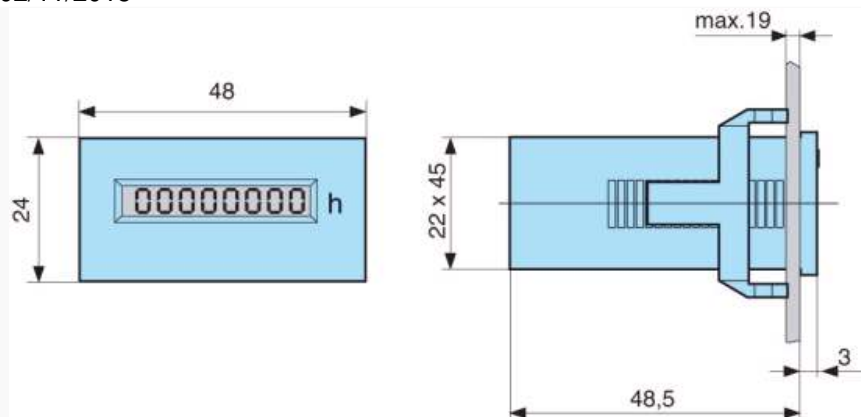

Dimensions (mm)

Panel cut-out

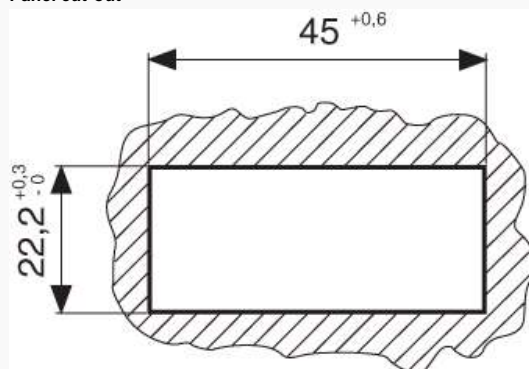

Dimensions (mm)

26546843 - Adaptor for cut-out

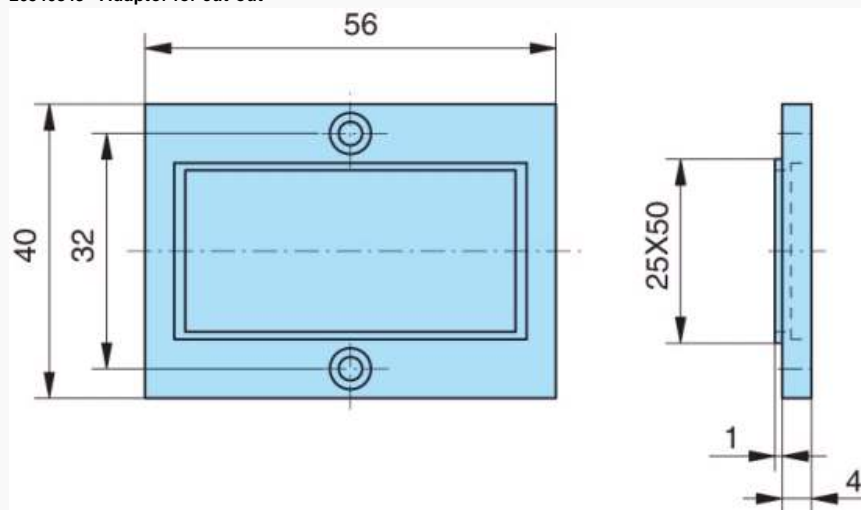

Dimensions (mm)

26546844 - Adaptor for cut-out

