



Zeppelinstrasse 19

D-82205 Gilching

Fon +49-8105-778090

info@lcd-module.de

<http://www.lcd-module.com>

SPECIFICATION

CUSTOMER : _____

MODULE NO.: **EA TFT050-84ANN**

APPROVED BY: (FOR CUSTOMER USE ONLY)	PCB VERSION:	DATA:
--	---------------------	--------------

SALES BY	APPROVED BY	CHECKED BY	PREPARED BY
ISSUED DATE: 2018/06/18			

Content

1.Summary

2.General Specification

3.Absolute Maximum Ratings

4.Electrical Characteristics

5.Optical Characteristics

6.Interface

7.Reliability

8.Contour Drawing

1. Summary

TFT 5.0" is a TN transmissive type color active matrix TFT liquid crystal display that use amorphous silicon TFT as switching devices. This module is a composed of a TFT_LCD module, It is usually designed for industrial application and this module follows RoHs.

1.1. Accessories

ZIF connector for display, bottom contact

ZIF connector for display, top contact

EA WF050-40S

EA WF050-40ST

2.General Specifications

Item	Dimension	Unit
Size	5.0	inch
Dot Matrix	800× 3(RGB) × 480	dots
Module dimension	120.7(W) ×75.8(H) ×2.8mm	mm
Active area	108(W) ×64.8 (H) mm	mm
Dot pitch	0.135(W) ×0.135(H) mm	mm
LCD type	TFT, Normally White, Transmissive	
View Direction	12 o'clock	
Gray Scale Inversion Direction	6 o'clock	
Aspect Ratio	16:9	
Backlight Type	LED ,Normally White	
With /Without TP	Without TP	
Surface	Anti-Glare	

*Color tone slight changed by temperature and driving voltage.

3. Absolute Maximum Ratings

Item	Symbol	Min	Typ	Max	Unit
Operating Temperature	TOP	-20	—	+70	°C
Storage Temperature	TST	-30	—	+80	°C

Note: Device is subject to be damaged permanently if stresses beyond those absolute maximum ratings listed above

1. Temp. $\leq 60^{\circ}\text{C}$, 90% RH MAX. Temp. $> 60^{\circ}\text{C}$, Absolute humidity shall be less than 90% RH at 60°C

4. Electrical Characteristics

4.1. Typical Operation Conditions

Item	Symbol	Values			Unit	Remark
		Min.	Typ.	Max.		
Power voltage	VDD	3.1	3.3	3.5	V	
Current for Driver(Black)	I _{dd}	-	110	170	mA	VDD=3.3V
Input logic high voltage	V _{IH}	0.7 VDD	-	VDD	V	Note 1
Input logic low voltage	V _{IL}	0	-	0.3 VDD		

Note1: CLK,DE,R0~R7, G0~7, B0~7.

4.2. Backlight Driving Conditions

Item	Symbol	Values			Unit	Remark
		Min.	Typ.	Max.		
Voltage for LED backlight	V _L	27	30	34	V	Note 1
Current for LED backlight	I _L	--	40	--	mA	
LED life time	-	--	50,000	-	Hr	Note 2

Note 1: The LED Supply Voltage is defined by the number of LED at Ta=25°C and I_L=20mA/pcs.

Note 2: The "LED life time" is defined as the module brightness decrease to 50% Original brightness at Ta=25°C and I_L=20mA/pcs. The LED lifetime could be decreased if operating I_L is larger than 25mA/pcs.

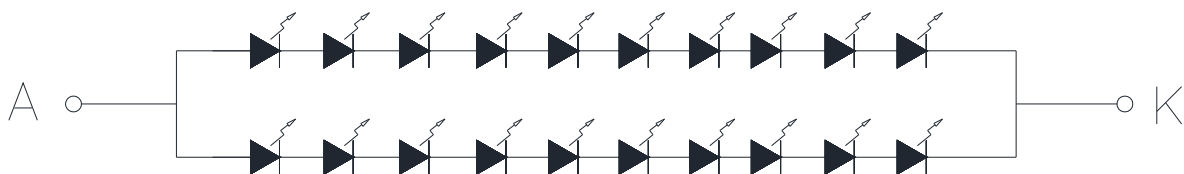

CIRCUIT DIAGRAM

4.3. Power Sequence

To prevent a latch-up or DC operation of the LCD module, the power on/off sequence should be as the diagram below.

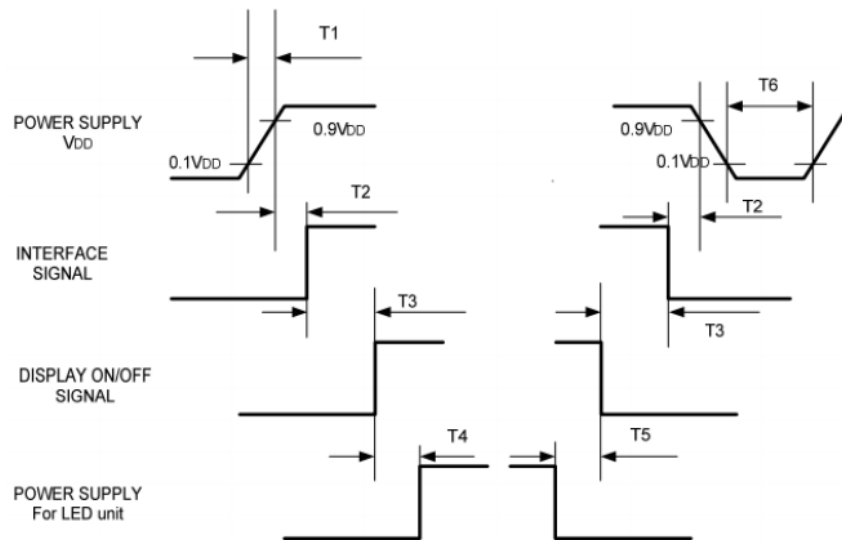

Symbol	Specification	Symbol	Specification
T1	$0 \leq T1 \leq 10 \text{ msec}$	T4	$200 \text{ msec} \leq T4$
T2	$16 \leq T2 \leq 100 \text{ msec}$	T5	$100 \text{ msec} \leq T5$
T3	$0 \leq T3 \leq 200 \text{ msec}$	T6	$16 \text{ msec} \leq T6$

4.4. Timing Characteristics

Timing conditions

Parallel DE mode RGB input timing table

Parameter	Symbol	Values			Unit	Remark
		Min.	Typ.	Max.		
CLK frequency	Fclk	26.4	33.3	46.8	MHz	
DEV period time	Tv	510	525	650	H	
DEV display area	Tvd	480			H	
DEV blanking	Tvd	30	45	170	H	
DEH period time	Th	862	1056	1200	CLK	
DEH display area	Thd	800			CLK	
DEH blanking	THb	62	256	400	CLK	
CLK cycle time	Tclk	21.3	30	37.8	ns	
Clock width of high level	Tcwh	40	50	60	%	
Clock width of low level	Tcwl	40	50	60	%	
Clock rising time	Trck	8	-	-	ns	
Clock falling time	Tfck	8	-	-	ns	
Data Setup Time	Tdasu	8	-	-	ns	
Data Hold Time	Tdahd	8	-	-	ns	
DE Setup Time	Tdesu	8	-	-	ns	
DE Hold Time	Tdehd	8	-	-	ns	

4.5. Timing diagram

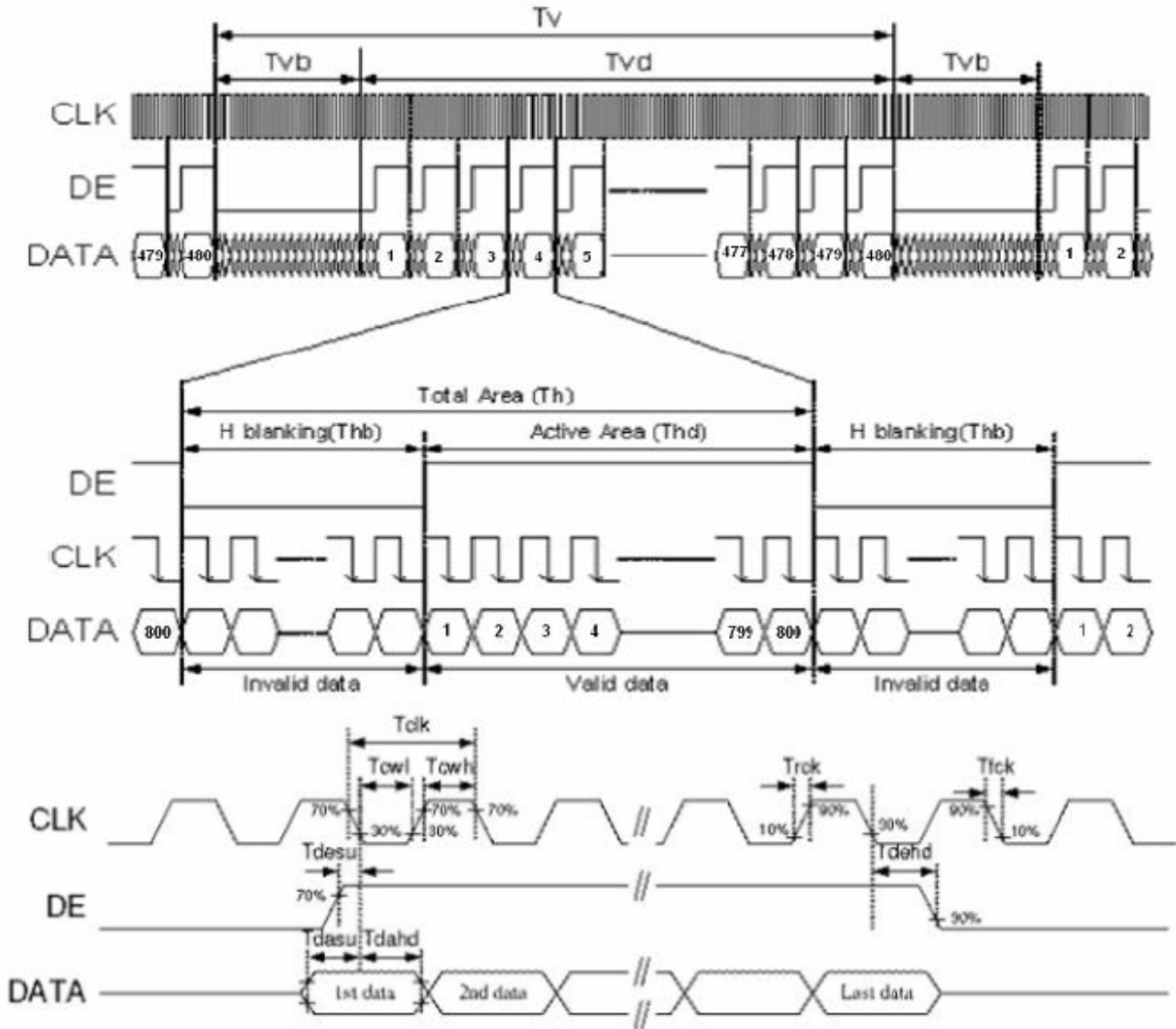

5. Optical Characteristics

Item	Symbol	Condition.	Min	Typ.	Max.	Unit	Remark	
Response time	Tr	$\theta = 0^\circ$ 、 $\Phi = 0^\circ$	-	10	20	.ms	Note 3,5	
	Tf		-	15	30	.ms		
Contrast ratio	CR	At optimized viewing angle	400	500	-	-	Note 4,5	
Color Chromaticity	White	Wx	$\theta = 0^\circ$ 、 $\Phi = 0^\circ$	0.26	0.31	0.36		Note 2,6,7
		Wy		0.28	0.33	0.38		
Viewing angle (Gray Scale Inversion Direction)	Hor.	Θ_R	CR ≥ 10	60	70	-	Deg.	Note 1
		Θ_L		60	70	-		
	Ver.	Φ_T		40	50	-		
		Φ_B		60	70	-		
Brightness	-	-	800	950	-	cd/m ²	Center of display	

Ta=25±2°C

Note 1: Definition of viewing angle range

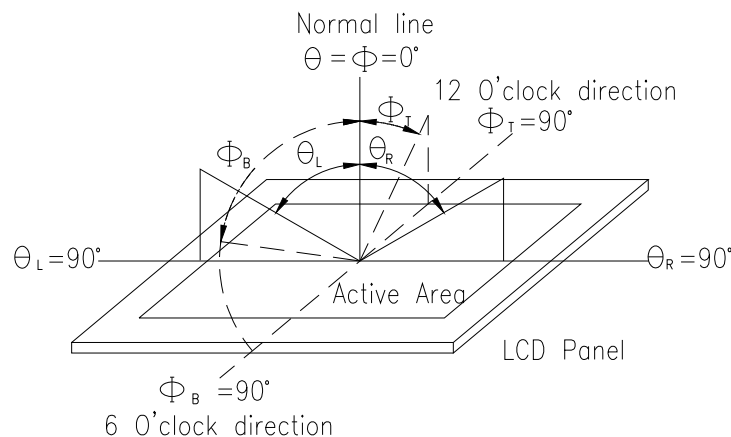

Fig. 6.1. Definition of viewing angle

Note 2: Test equipment setup:

After stabilizing and leaving the panel alone at a driven temperature for 10 minutes, the measurement should be executed. Measurement should be executed in a stable, windless, and dark room. Optical specifications are measured by Topcon BM-7 or BM-5 luminance meter 1.0° field of view at a distance

of 50cm and normal direction.

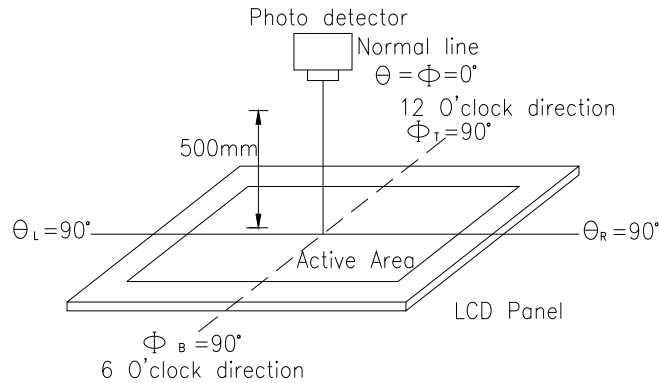
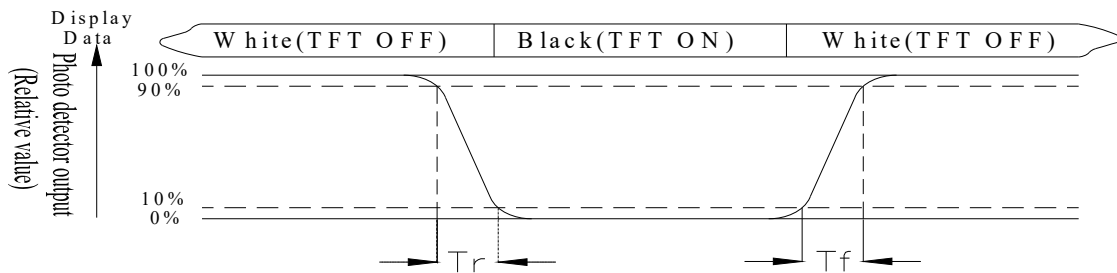

Fig. 6.2. Optical measurement system setup

Note 3: Definition of Response time:

The response time is defined as the LCD optical switching time interval between “White” state and “Black” state. Rise time, T_r , is the time between photo detector output intensity changed from 90% to 10%. And fall time, T_f , is the time between photo detector output intensity changed from 10% to 90%



Note 4: Definition of contrast ratio:

The contrast ratio is defined as the following expression.

$$\text{Contrast ratio (CR)} = \frac{\text{Luminance measured when LCD on the "White" state}}{\text{Luminance measured when LCD on the "Black" state}}$$

Note 5: White $V_i = V_{i50} \pm 1.5V$

Black $V_i = V_{i50} \pm 2.0V$

“±” means that the analog input signal swings in phase with VCOM signal.

“±” means that the analog input signal swings out of phase with VCOM signal.

The 100% transmission is defined as the transmission of LCD panel when all the input terminals of module are electrically opened.

Note 6: Definition of color chromaticity (CIE 1931)

Color coordinates measured at the center point of LCD

Note 7: Measured at the center area of the panel when all the input terminals of LCD panel are electrically opened.

6.Interface

6.1. LCM PIN Definition

Pin	Symbol	Function	Remark
1	VLED-	Power for LED backlight (Cathode)	
2	VLED+	Power for LED backlight (Anode)	
3	GND	Power Ground	
4	VDD	Power voltage	
5	R0	Red data (LSB)	
6	R1	Red data	
7	R2	Red data	
8	R3	Red data	
9	R4	Red data	
10	R5	Red data	
11	R6	Red data	
12	R7	Red data(MSB)	
13	G0	Green data(LSB)	
14	G1	Green data	
15	G2	Green data	
16	G3	Green data	
17	G4	Green data	
18	G5	Green data	
19	G6	Green data	
20	G7	Green data(MSB)	
21	B0	Blue data(LSB)	
22	B1	Blue data	
23	B2	Blue data	
24	B3	Blue data	
25	B4	Blue data	
26	B5	Blue data	
27	B6	Blue data	
28	B7	Blue data(MSB)	
29	GND	Power Ground	
30	CLK	Sample clock	
31	DISP	Display on/off	
32	HS	Horizontal sync input	
33	VS	Vertical sync input	
34	DE	Data input enable	
35	NC	No connection	
36	GND	Power Ground	
37	NC	No connection	
38	NC	No connection	
39	NC	No connection	
40	NC	No connection	

7. Reliability

Content of Reliability Test (Wide temperature, -20°C~70°C)

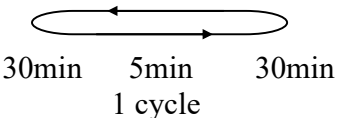
Environmental Test			
Test Item	Content of Test	Test Condition	Note
High Temperature storage	Endurance test applying the high storage temperature for a long time.	80°C 200hrs	2
Low Temperature storage	Endurance test applying the low storage temperature for a long time.	-30°C 200hrs	1,2
High Temperature Operation	Endurance test applying the electric stress (Voltage & Current) and the thermal stress to the element for a long time.	70°C 200hrs	—
Low Temperature Operation	Endurance test applying the electric stress under low temperature for a long time.	-20°C 200hrs	1
High Temperature/ Humidity Operation	The module should be allowed to stand at 60°C,90%RH max	60°C,90%RH 96hrs	1,2
Thermal shock resistance	The sample should be allowed stand the following 10 cycles of operation <div style="text-align: center;">  <p>30min 5min 30min 1 cycle</p> </div>	-20°C/70°C 10 cycles	—
Vibration test	Endurance test applying the vibration during transportation and using.	Total fixed amplitude : 1.5mm Vibration Frequency : 10~55Hz One cycle 60 seconds to 3 directions of X,Y,Z for Each 15 minutes	3
Static electricity test	Endurance test applying the electric stress to the terminal.	VS=±600V(contact), ±800v(air), RS=330Ω CS=150pF 10 times	—

Note1: No dew condensation to be observed.

Note2: The function test shall be conducted after 4 hours storage at the normal Temperature and humidity after remove from the test chamber.

Note3: The packing have to including into the vibration testing.

8. Contour Drawing

