

CA080, CA081, CA082, CA083, CA084 Series

BiMOS Operational Amplifiers

With MOS/FET Input, Composite Bipolar/MOS Output

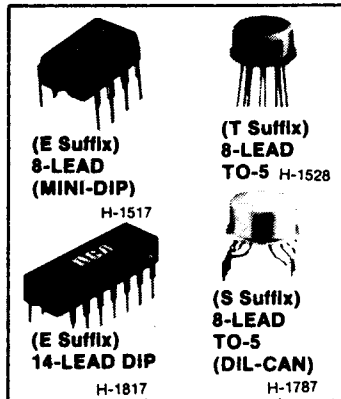

Single Amplifier: CA080, CA081

Dual Amplifier: CA082, CA083

Quad Amplifier: CA084

Features:

- Very low input bias and offset currents
- Input impedance typically $1.5 \times 10^{12} \Omega$
- Low input offset voltage
- Wide common-mode input voltage range
- Low power consumption
- Fast slew rate
- Unity-gain bandwidth = 5 MHz (typ.)
- Wide output voltage swing

The RCA-CA080, CA081, CA082, CA083, and CA084 BiMOS operational amplifiers combine the advantages of MOS and bipolar transistors on the same monolithic chip. The gate-protected MOS/FET (PMOS) input transistors provide high input impedance and a wide common-mode input voltage range. The bipolar and MOS output transistors allow a wide output voltage swing and provide a high output current capability.

- Low distortion
- Continuous short circuit protection
- Direct replacement for industry type TL080 series in most applications

Applications:

- Inverters
- High-Q notch filters
- IC preamplifiers
- Unity Gain Absolute Value Amplifiers
- Sample and hold amplifiers
- Active filters

Package Selection Chart

Type No.	Package Type & Suffix			
	8L TO-5	DIL-CAN	Mini-DIP	14L DIP
CA080	T	S	E	
CA080A	T	S	E	
CA080B			E	
CA080C	T	S		
CA081	T	S	E	
CA081A	T	S	E	
CA081B			E	
CA081C	T	S		
CA082	T	S	E	
CA082A	T	S	E	
CA082B			E	
CA082C	T	S		
CA083				E
CA083A				E
CA083B				E
CA084				E
CA084A				E
CA084B				E

The CA080 is externally phase-compensated, and the CA081, CA082, CA083, and CA084 are internally phase-compensated. All types except the CA082 have provisions for external offset nulling.

The CA080, CA081, CA082, CA083, and CA084 are available in chip form (H Suffix).

Operating Temperature Ranges:

-55 to +125°C**0 to +70°C**

CA080T, CA080S

CA080CT, CA080CS

CA080AT, CA080AS

CA080BE

CA081T, CA081S

CA081CT, CA081CS

CA081AT, CA081AS

CA081BE

CA082T, CA082S

CA082CT, CA082CS

CA082AT, CA082AS

CA082BE

CA083BE, CA083AE

CA083BE

CA084, CA084AE

CA084BE

Linear Integrated Circuits

CA080, CA081, CA082, CA083, CA084 Series

MAXIMUM RATINGS, Absolute Maximum Values:

DC SUPPLY VOLTAGE V_{\pm}	± 18 V
DIFFERENTIAL INPUT VOLTAGE	± 16 V
INPUT VOLTAGE RANGE	± 15 V
INPUT CURRENT	± 1 mA
OUTPUT SHORT-CIRCUIT DURATION	UNLIMITED*
POWER DISSIPATION, P_d :	
At $T_A = 25^\circ\text{C}$:	
E Suffix	625 mW
T Suffix	680 mW
Derating Factors:	
Mini-DIP	Derate linearly at 6.67 mW/ $^\circ\text{C}$ above 56 $^\circ\text{C}$
14-Lead DIP	Derate linearly at 6.67 mW/ $^\circ\text{C}$ above 56 $^\circ\text{C}$
TO-5	Derate linearly at 6.67 mW/ $^\circ\text{C}$ above 56 $^\circ\text{C}$
AMBIENT TEMPERATURE RANGE:	
CT, CS, E, Suffixes	0 to +70 $^\circ\text{C}$
T, S, Suffixes	-55 to +125 $^\circ\text{C}$
STORAGE TEMPERATURE RANGE, ALL TYPES	
LEAD TEMPERATURE (DURING SOLDERING):	
At distance 1/16 \pm 1/32 (1.59 \pm 0.79 mm) from case for 10 seconds max.	+265 $^\circ\text{C}$

* The output may be shorted to ground or either supply if the maximum temperature and dissipation ratings are observed.

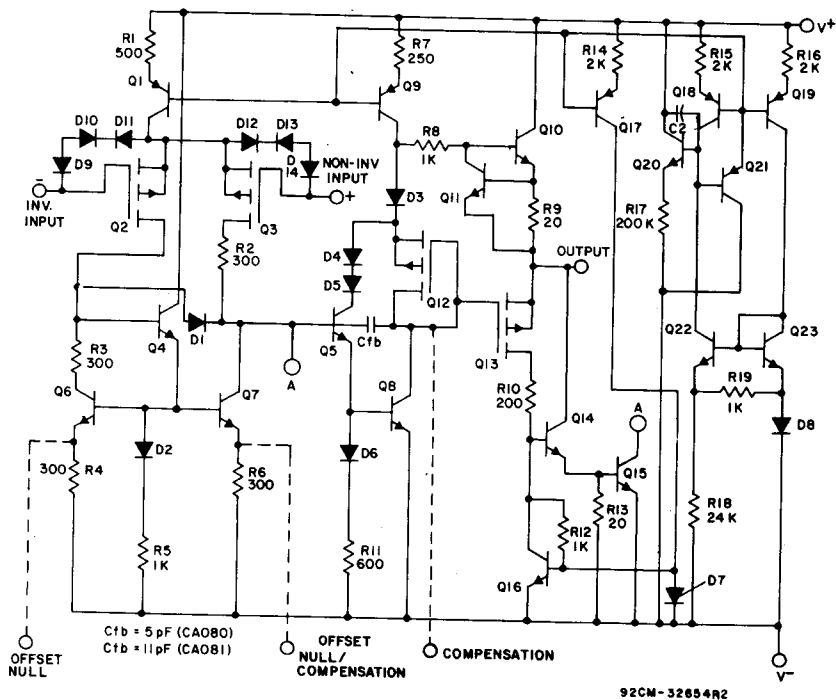

Fig. 1 - Schematic diagram of the CA080, CA081, CA082, CA083, and CA084.

CA080, CA081, CA082, CA083, CA084 Series

Texas Instruments-to-RCA Package Suffix Cross Reference Chart

Texas Instruments

Suffix	Description
ACJG	Ceramic DIL
ACL	TO-5
ACN	Plastic DIL
ACP	Plastic DIL
CJG	Ceramic DIL
CL	TO-5
CN	Plastic DIL
CP	Plastic DIL
IJG	Ceramic DIL
IL	TO-5
IP	Plastic DIL
MJG	Ceramic DIL
ML	TO-5
AML	TO-5
BCP	Plastic DIL

RCA

Suffix	Description
AS	DILCAN TO-5
AT	TO-5
AE	Plastic DIL
AE	Plastic DIL
CS	DILCAN TO-5
CT	TO-5
E	Plastic DIL
E	Plastic DIL
S	DILCAN TO-5
T	TO-5
E	DILCAN TO-5
S	DILCAN TO-5
T	TO-5
AT	TO-5
BE	Plastic DIL

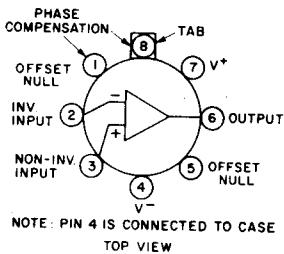

CA080
T, S Suffixes

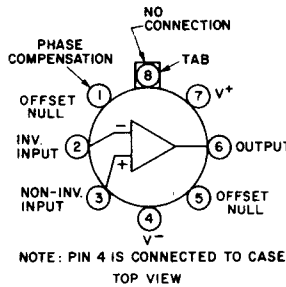

CA081
T, S Suffixes

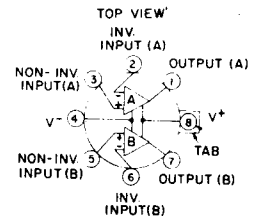

CA082
T, S Suffixes

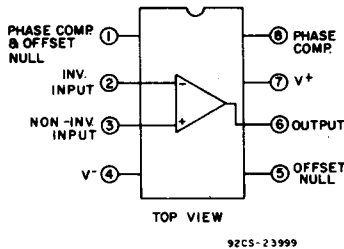

CA080
E Suffix

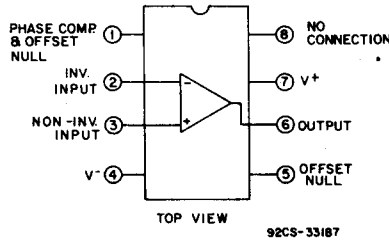

CA081
E Suffix

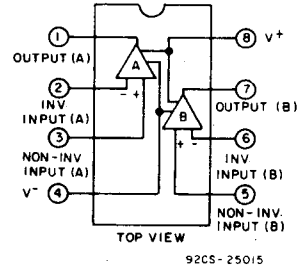

CA082
E Suffix

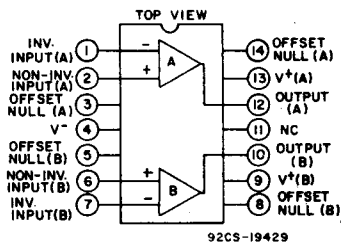

CA083
E Suffix

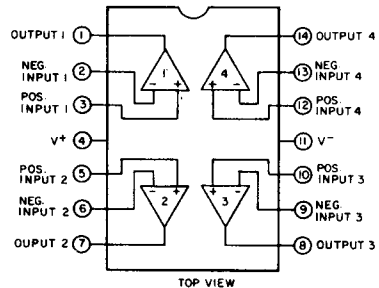

CA084
E Suffix

Fig. 2 - Terminal assignments.

Linear Integrated Circuits

CA080, CA081, CA082, CA083, CA084 Series

TYPICAL OPERATING CHARACTERISTICS at
 $V_{\pm} = 15\text{ V}$, $T_A = 25^{\circ}\text{C}$

CHARACTERISTIC	TEST CONDITIONS	VALUE	UNITS
Slew Rate at Unity Gain, SR	$V_I = 10\text{ V}$, $R_L = 2\text{ k}\Omega$, $C_L = 100\text{ pF}$, $A_{VD} = 1$	13	$\text{V}/\mu\text{s}$
Rise Time, t_r	$V_I = 10\text{ V}$, $R_L = 2\text{ k}\Omega$, $C_L = 100\text{ pF}$, $A_{VD} = 1$	0.1	μs
Overshoot Factor	$C_L = 100\text{ pF}$, $A_{VD} = 1$	10	%
Equivalent Input Noise Voltage, e_n	$R_S = 100\ \Omega$, $f = 1\text{ kHz}$	40	$\text{nV}/\sqrt{\text{Hz}}$

ELECTRICAL CHARACTERISTICS at $T_A = 25^{\circ}\text{C}$ and $T_A = -55$ to $+125^{\circ}\text{C}$
 for types supplied in TO-5 style packages (T, S Suffixes). $V_{\pm} = \pm 15\text{ V}$

This does not include CA080C, CA081C, or CA082C. These types are supplied in TO-5 packages, but they are specified over the range of 0 to 70°C , and their limits are the same as those for the CA080, CA081, CA082, and CA083 in plastic packages over the range 0 to 70°C .

CHARACTERISTIC	TEST CONDITIONS		LIMITS						UNITS
			CA080T, S CA081T, S CA082T, S			CA080AT, S CA081AT, S CA082AT, S			
			Min.	Typ.	Max.	Min.	Typ.	Max.	
Input Offset Voltage, V_{IO}	$R_S = 50\ \Omega$	X	—	3	6	—	2	3	mV
		X	—	—	9	—	—	5	
Temperature Coefficient of Input Offset Voltage, αV_{IO}	$R_S = 50\ \Omega$	X	—	10	—	—	10	—	$\mu\text{V}/^{\circ}\text{C}$
Input Offset Current, I_{IO}		X	—	5	20	—	5	20	pA
		X	—	—	4	—	—	2	
Input Current		X	—	15	40	—	15	40	pA
		X	—	—	10	—	—	5	
Common-Mode Input Voltage Range, V_{ICR}		X	± 12	—	—	± 12	—	—	V
Maximum Output Voltage Swing, V_{OP-P}	$R_L = 10\text{ k}\Omega$	X	24	27	—	24	27	—	V
	$R_L \geq 10\text{ k}\Omega$	X	24	—	—	24	—	—	
	$R_L \geq 2\text{ k}\Omega$	X	20	24	—	20	24	—	
Large-Signal Differential Voltage Gain, A_{VD}	$R_L \geq 2\text{ k}\Omega$, $V_O = \pm 10\text{ V}$	X	50	200	—	50	200	—	V/mV
		X	25	—	—	25	—	—	
Unity-Gain Bandwidth		X	—	5	—	—	5	—	MHz
Input Resistance, R_I		X	—	1.5	—	—	1.5	—	$\text{T}\Omega$
Common-Mode Rejection Ratio, CMRR	$R_S < 10\text{ k}\Omega$	X	80	86	—	80	86	—	dB
Power Supply Rejection Ratio, PSRR ($\Delta V_{\pm} / \pm \Delta V_{IO}$)	$R_S < 10\text{ k}\Omega$	X	80	86	—	80	86	—	dB
Supply Current, I_{\pm} (per amp., CA082, CA083)	No load, No Signal	X	—	1.4	2.8	—	1.4	2.8	mA
Channel Separation, V_{O1}/V_{O2} (between amps., CA082, CA083)	$A_{VD} = 100$	X	—	120	—	—	120	—	dB

CA080, CA081, CA082, CA083, CA084 Series

ELECTRICAL CHARACTERISTICS at $T_A = 25^\circ\text{C}$, $T_A = 0$ to $+70^\circ\text{C}$
for types supplied in plastic dual-in-line packages (E Suffix). $V^+ = \pm 15\text{ V}$

CHARACTERISTIC	TEST CONDITIONS		LIMITS						UNITS
			CA080BE CA081BE CA082BE CA083BE CA084BE			CA080AE CA081AE CA082AE CA083AE CA084AE			
			Min.	Typ.	Max.	Min.	Typ.	Max.	
Input Offset Voltage, V_{IO}	$R_S = 50\Omega$	X	—	2	3	—	3	6	mV
		X	—	—	5	—	—	7.5	
Temperature Coefficient of Input Offset Voltage, αV_{IO}	$R_S = 50\Omega$	X	—	10	—	—	10	—	$\mu\text{V}/^\circ\text{C}$
Input Offset Current, I_{IO}		X	—	5	10	—	5	20	pA
		X	—	—	0.4	—	—	0.6	nA
Input Current		X	—	15	30	—	15	40	pA
		X	—	—	0.7	—	—	1	nA
Common-Mode Input Voltage Range, V_{ICR}		X	± 12	—	—	± 12	—	—	V
Maximum Output Voltage Swing, V_{OP-P}	$R_L = 10\text{ k}\Omega$	X	24	27	—	24	27	—	V
	$R_L \geq 10\text{ k}\Omega$	X	24	—	—	24	—	—	
	$R_L \geq 2\text{ k}\Omega$	X	20	24	—	20	24	—	
Large-Signal Differential Voltage Gain, A_{VD}	$R_L \geq 2\text{ k}\Omega$, $V_O = \pm 10\text{V}$	X	50	200	—	50	200	—	V/mV
		X	—	—	—	—	—	—	
Unity-Gain Bandwidth		X	—	5	—	—	5	—	MHz
Input Resistance, R_I		X	—	1.5	—	—	1.5	—	T Ω
Common-Mode Rejection Ratio, CMRR	$R_S \leq 10\text{ k}\Omega$	X	80	86	—	80	86	—	dB
Power Supply Rejection Ratio, PSRR ($\Delta V^+ / \pm \Delta V_{IO}$)	$R_S \leq 10\text{ k}\Omega$	X	80	86	—	80	86	—	dB
Supply Current, I^+ (per amp., CA082, CA083, CA084)	No load, No Signal	X	—	1.4	2.8	—	1.4	2.8	mA
Channel Separation, V_{O1}/V_{O2} (between amps., CA082, CA083)	$AVD = 100$	X	—	120	—	—	120	—	dB

Linear Integrated Circuits

CA080, CA081, CA082, CA083, CA084 Series

ELECTRICAL CHARACTERISTICS at $T_A = 25^\circ\text{C}$, $T_A = 0$ to 70°C for types supplied in plastic dual-in-line packages (E Suffix). $V^+ = \pm 15\text{ V}$

The limits for the CA080C, CA081C, and CA082C in TO-5 packages are the same as those for the types in this chart.

CHARACTERISTIC	TEST CONDITIONS	LIMITS			UNITS		
		CA080E, T CA081E, T CA082E, T CA083E CA084E					
		Min.	Typ.	Max.			
Input Offset Voltage, V_{IO}	$R_S = 50\Omega$	X	—	5	15	mV	
			X	—	20		
Temperature Coefficient of Input Offset Voltage, αV_{IO}	$R_S = 50\Omega$		X	—	10	—	$\mu\text{V}/^\circ\text{C}$
Input Offset Current, I_{IO}		X		—	5	30	pA
			X	—	—	1	nA
Input Current		X		—	15	50	pA
			X	—	—	2	nA
Common-Mode Input Voltage Range, V_{ICR}		X		± 10	—	—	V
Maximum Output Voltage Swing, V_{OP-P}	$R_L = 10\text{ k}\Omega$	X		24	27	—	V
	$R_L \geq 10\text{ k}\Omega$		X	24	—	—	
	$R_L \geq 2\text{ k}\Omega$		X	20	24	—	
Large-Signal Differential Voltage Gain, A_{VD}	$R_L \geq 2\text{ k}\Omega$, $V_O = \pm 10\text{ V}$	X		25	200	—	V/mV
			X	—	—	—	
Unity-Gain Bandwidth		X		—	5	—	MHz
Input Resistance, R_I		X		—	1.5	—	$\text{T}\Omega$
Common-Mode Rejection Ratio, CMRR	$R_S \leq 10\text{ k}\Omega$	X		70	76	—	dB
Power Supply Rejection Ratio, PSRR ($\Delta V^+ / \pm \Delta V_{IO}$)	$R_S \leq 10\text{ k}\Omega$	X		70	76	—	dB
Supply Current, I^+ (per amp., CA082, CA083)	No load, No Signal	X		—	1.4	2.8	mA
Channel Separation, V_{O1}/V_{O2} (between amps., CA082, CA083)	$A_{VD} = 100$	X		—	120	—	dB

CA080, CA081, CA082, CA083, CA084 Series

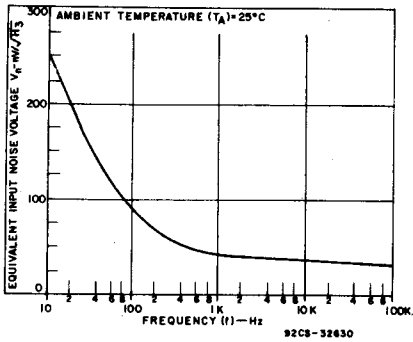

Fig. 3 - Noise voltage as a function of frequency.

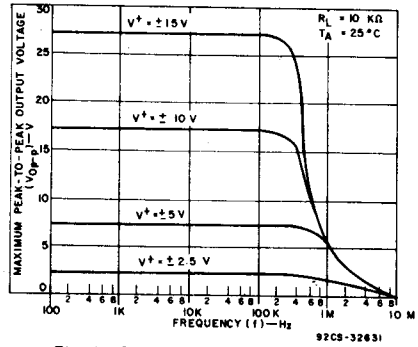

Fig. 4 - Output voltage as a function of frequency.

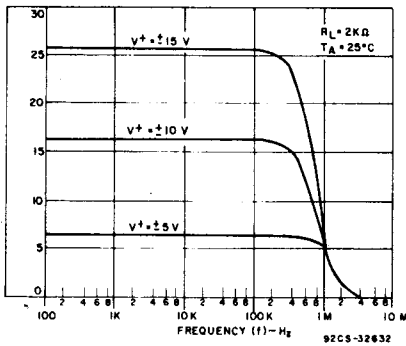

Fig. 5 - Output voltage as a function of frequency.

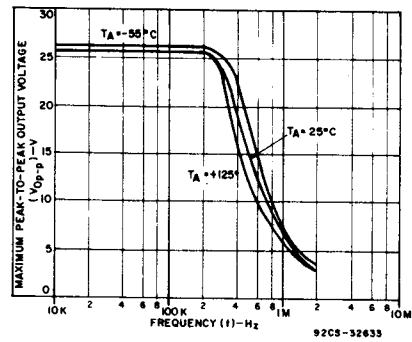

Fig. 6 - Output voltage as a function of frequency.

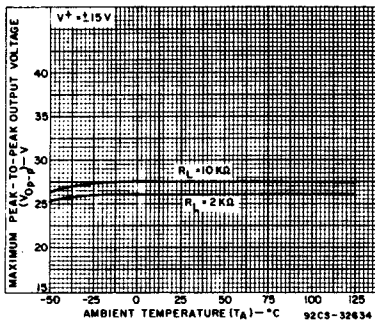

Fig. 7 - Output voltage as a function of ambient temperature.

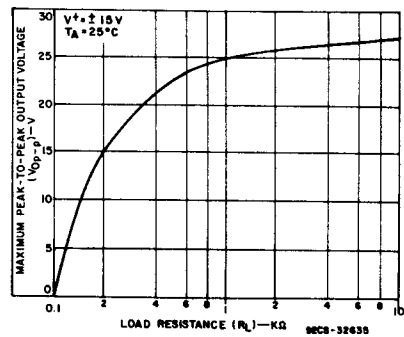

Fig. 8 - Output voltage as a function of load resistance.

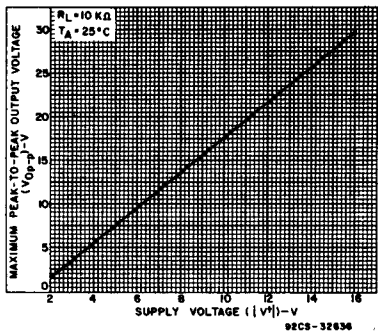

Fig. 9 - Output voltage as a function of supply voltage.

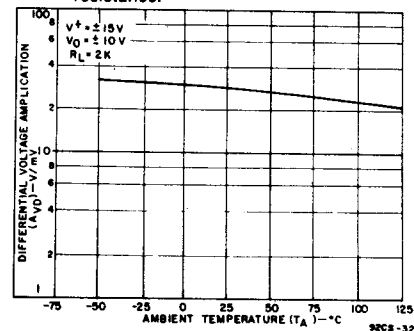

Fig. 10 - Differential voltage amplification as a function of ambient temperature.

Linear Integrated Circuits

CA080, CA081, CA082, CA083, CA084 Series

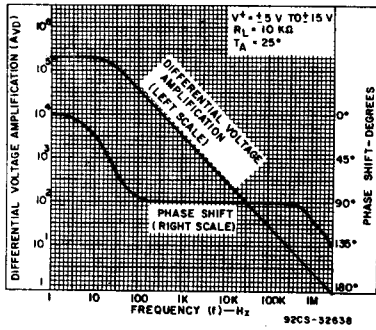

Fig. 11 - Differential voltage amplification as a function of frequency.

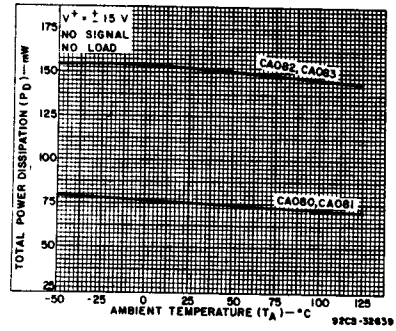

Fig. 12 - Total power dissipation as a function of ambient temperature.

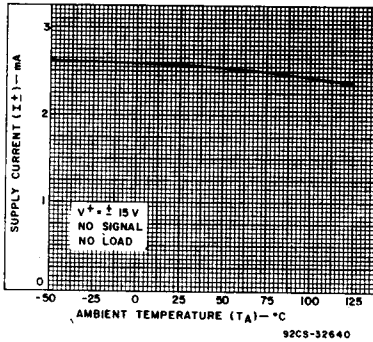

Fig. 13 - Supply current as a function of ambient temperature.

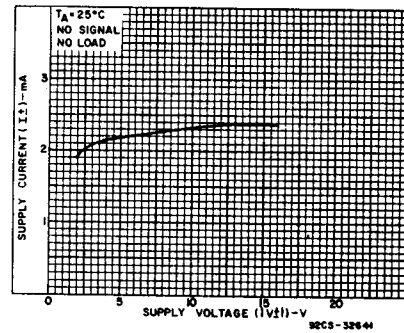

Fig. 14 - Supply current as a function of supply voltage.

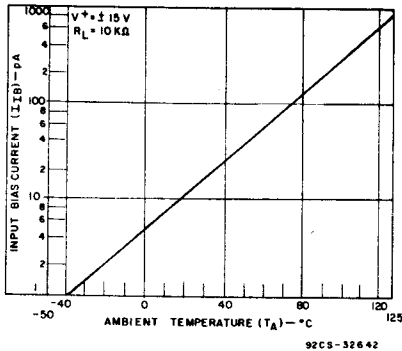

Fig. 15 - Input bias current as a function of ambient temperature.

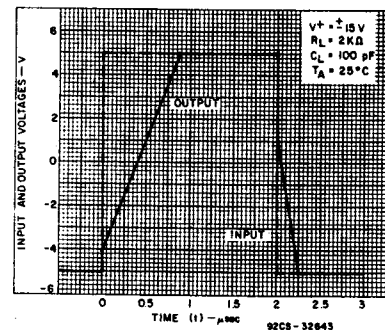

Fig. 16 - Voltage follower large-signal pulse response.

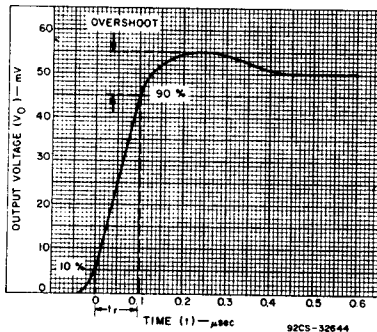

Fig. 17 - Output voltage as a function of elapsed time.

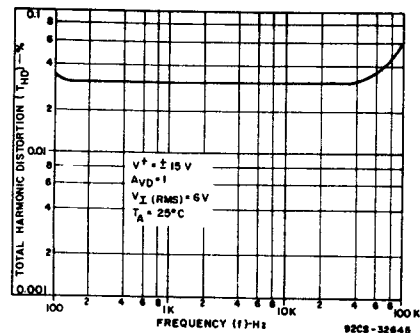

Fig. 18 - Total harmonic distortion as a function of frequency.

Operational Amplifiers

CA080, CA081, CA082, CA083, CA084 Series

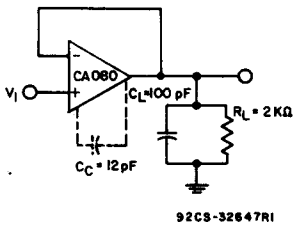

Fig. 19 - Unity-gain amplifier.

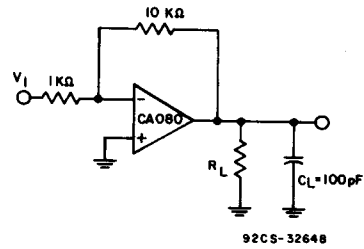

Fig. 20 - 10X inverting amplifier.

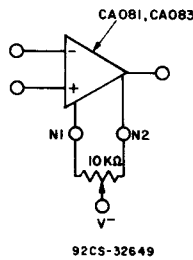
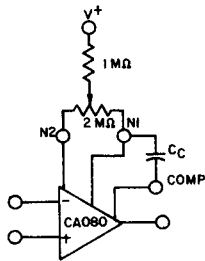

Fig. 21 - Input-offset voltage null circuits.

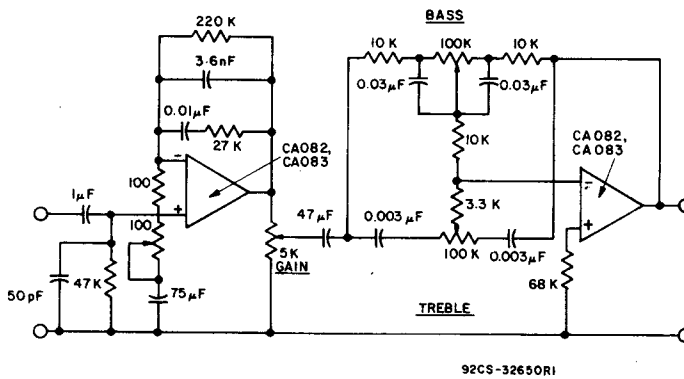

Fig. 22 - IC preamplifier.

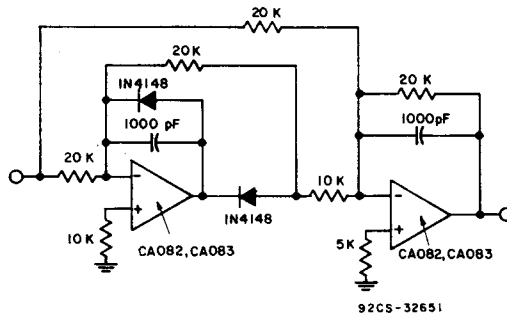

Fig. 23 - Unity-gain absolute-value amplifier.

Linear Integrated Circuits

CA080, CA081, CA082, CA083, CA084 Series

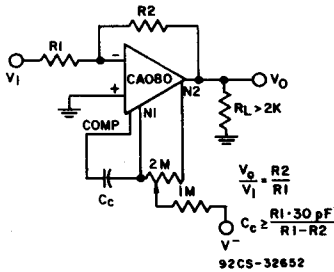

Fig. 24 - Inverting amplifier with single-pole compensation and offset adjustment.

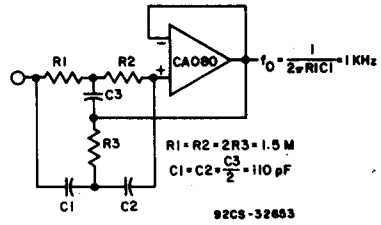

Fig. 25 - High Q notch filter.

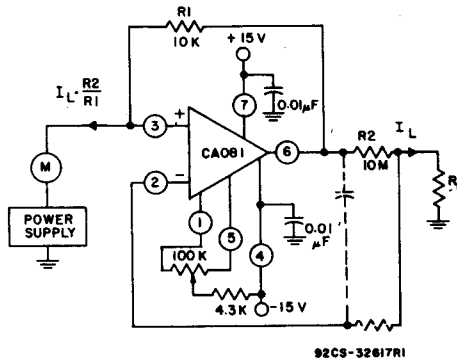

Fig. 26 - Basic current amplifier for low-current measurement systems.

CURRENT AMPLIFIER

The low input-terminal current needed to drive the CA081 makes it ideal for use in current-amplifier applications such as the one shown in Fig.26. In this circuit, low current is supplied at the input potential as the power supply to load resistor R_L . This load current is increased by the multiplication factor R_2/R_1 , when the load current is monitored by the power supply meter M. Thus, if the load current is 100 nA, with values shown, the load current presented to the supply will be 100 μ A; a much easier current to measure in many systems.

Note that the input and output voltages are transferred at the same potential and only the output current is multiplied by the scale factor.

The dotted components show a method of decoupling the circuit from the effects of high output-load capacitance and the potential oscillation in this situation. Essentially, the necessary high-frequency feedback is provided by the capacitor with the dotted series resistor providing load decoupling.