



WR-112 Standard Gain Horn with 20 dBi gain,  
End Launch N Female connector

**Technical Data Sheet**

**PEWAN112-20ELNF**

**Features**

- 7.05 GHz to 10 GHz
- WR-112 Waveguide Band
- 20 dBi Nominal Gain
- N Female End Launch Connector

**Applications**

- Antenna Measurements
- Wireless Communication
- Laboratory Use
- Microwave Radio Systems
- Radome Testing
- Automotive Antenna Test
- Solutions
- Radar Cross Section
- Satellite Antenna Testing

**Description**

The PEWAN112-20ELNF standard gain horn antenna (also known as waveguide horn) from Pasternack is part of our comprehensive selection of waveguide antennas. This standard gain horn is mated with a WR-112 to N Female End Launch waveguide to coaxial adapter and operates from 7.05 GHz to 10 GHz.

Our PEWAN112-20ELNF standard gain horn antenna has a nominal gain of 20 dBi with a Horizontal and Vertical HPBW (Half Power Beam Width) of 17.5 dB and 17.3 dB respectively. Pasternack's N Female End Launch to WR-112 standard gain horns are available in 10, 15 and 20 dBi models with pyramidal shape and connectorized input.

Waveguide antennas, such as the PEWAN112-20ELNF are used in a wide variety of applications due to the high-power handling capability, low loss, high directivity, and near constant electrical performance. Our WR-112 waveguide antennas with N Female End Launch interface is part of over 40,000 RF, microwave and millimeter wave components from Pasternack available worldwide and Ship same day.

**Configuration**

Design: WR-112 Standard Gain Horn  
Coaxial Interface: N Female

**Electrical Specifications**

Description	Minimum	Typical	Maximum	Units
Frequency Range	7.05		10	GHz
<b>Waveguide Standard Gain Horn</b>				
Gain		20		dBi
Horizontal Half Power Beam Width		17.5		Degrees
Vertical Half Power Beam Width		17.3		Degrees
<b>Waveguide to Coaxial Adapter</b>				
Input VSWR			1.3:1	

Click the following link (or enter part number in "SEARCH" on website) to obtain additional part information including price, inventory and certifications: [WR-112 Standard Gain Horn with 20 dBi gain, End Launch N Female connector PEWAN112-20ELNF](#)



WR-112 Standard Gain Horn with 20 dBi gain,  
End Launch N Female connector

## Technical Data Sheet

**PEWAN112-20ELNF**

### Mechanical Specifications

#### Size

Length	13.657 in [346.89 mm]
Width	5.487 in [139.37 mm]
Height	4.071 in [103.4 mm]
Weight	1.2785 lbs [579.92 g]

#### RF Connector

Type	N Female
Specification	End Launch

#### Waveguide Interface

Waveguide Size	WR-112
----------------	--------

### Environmental Specifications

**Compliance Certifications** (see [product page](#) for current document)

### Plotted and Other Data

Notes:

Click the following link (or enter part number in "SEARCH" on website) to obtain additional part information including price, inventory and certifications: [WR-112 Standard Gain Horn with 20 dBi gain, End Launch N Female connector PEWAN112-20ELNF](#)



WR-112 Standard Gain Horn with 20 dBi gain,  
End Launch N Female connector

**Technical Data Sheet**

**PEWAN112-20ELNF**

Typical Performance Data

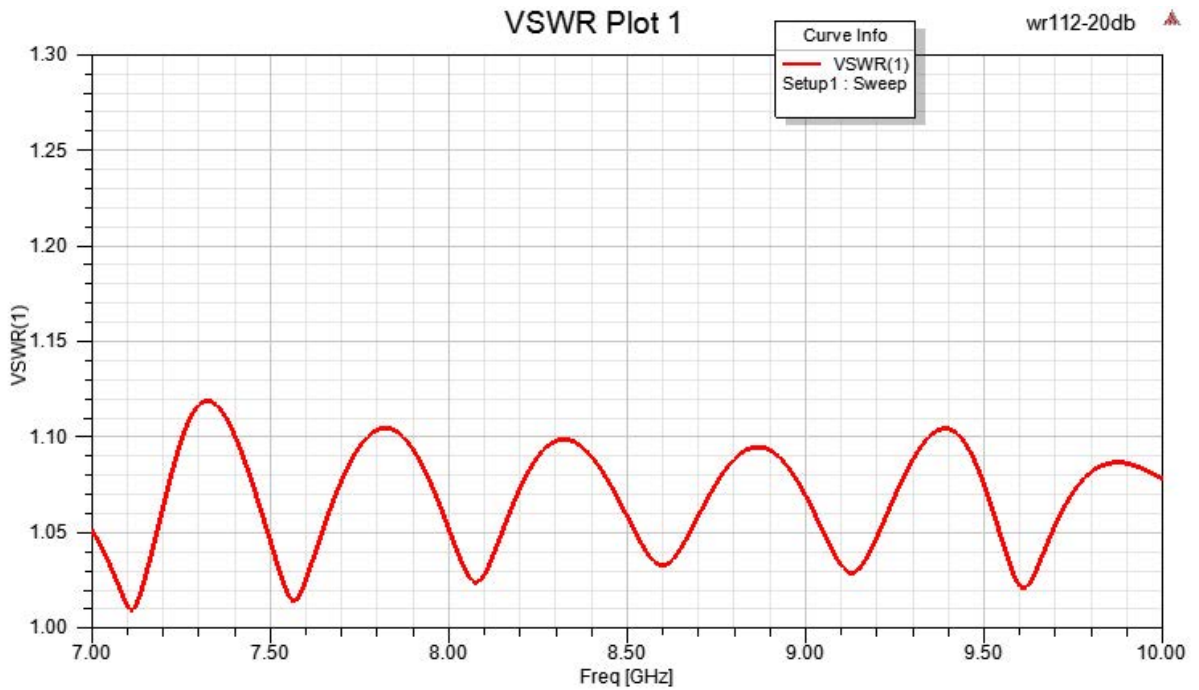

Click the following link (or enter part number in "SEARCH" on website) to obtain additional part information including price, inventory and certifications: [WR-112 Standard Gain Horn with 20 dBi gain, End Launch N Female connector PEWAN112-20ELNF](#)



WR-112 Standard Gain Horn with 20 dBi gain,  
End Launch N Female connector

**Technical Data Sheet**

**PEWAN112-20ELNF**

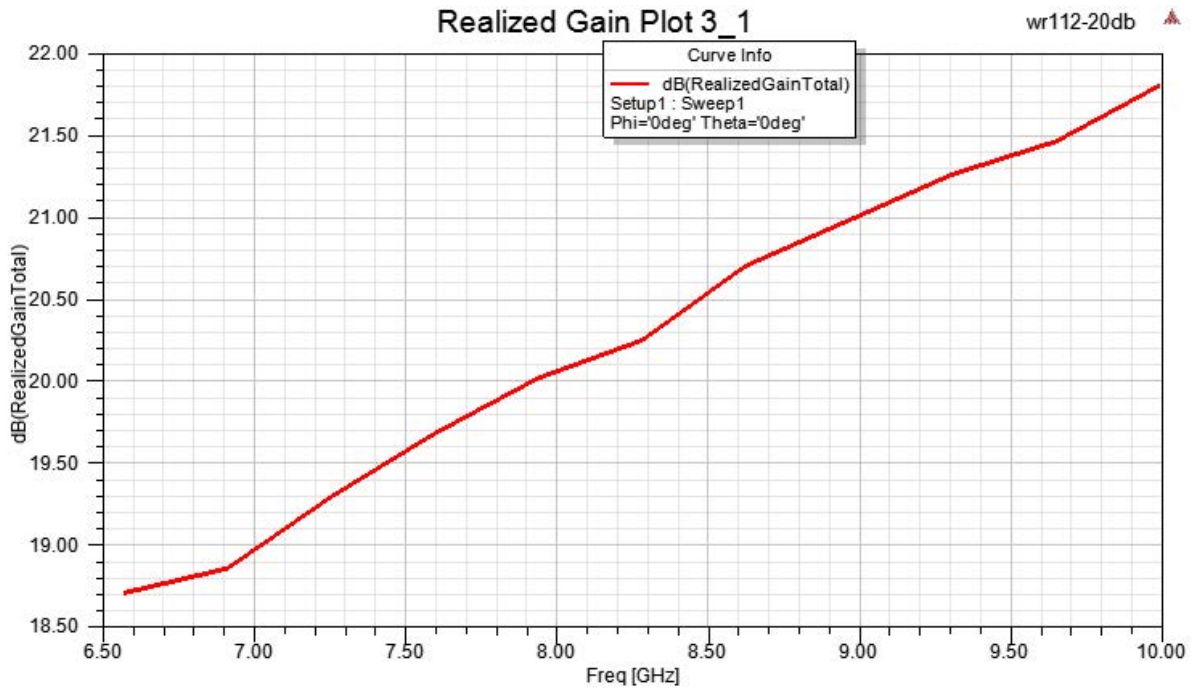

Click the following link (or enter part number in "SEARCH" on website) to obtain additional part information including price, inventory and certifications: [WR-112 Standard Gain Horn with 20 dBi gain, End Launch N Female connector PEWAN112-20ELNF](#)



WR-112 Standard Gain Horn with 20 dBi gain,  
End Launch N Female connector

**Technical Data Sheet**

**PEWAN112-20ELNF**

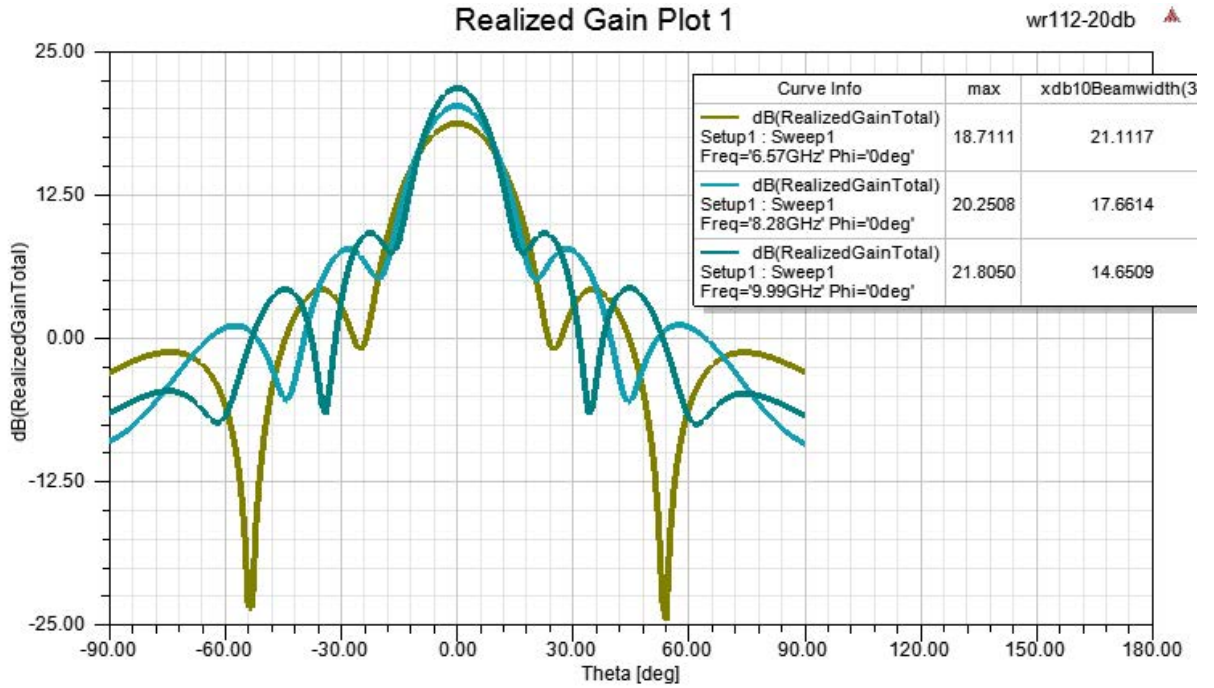

Click the following link (or enter part number in "SEARCH" on website) to obtain additional part information including price, inventory and certifications: [WR-112 Standard Gain Horn with 20 dBi gain, End Launch N Female connector PEWAN112-20ELNF](#)



WR-112 Standard Gain Horn with 20 dBi gain,  
End Launch N Female connector

**Technical Data Sheet**

**PEWAN112-20ELNF**

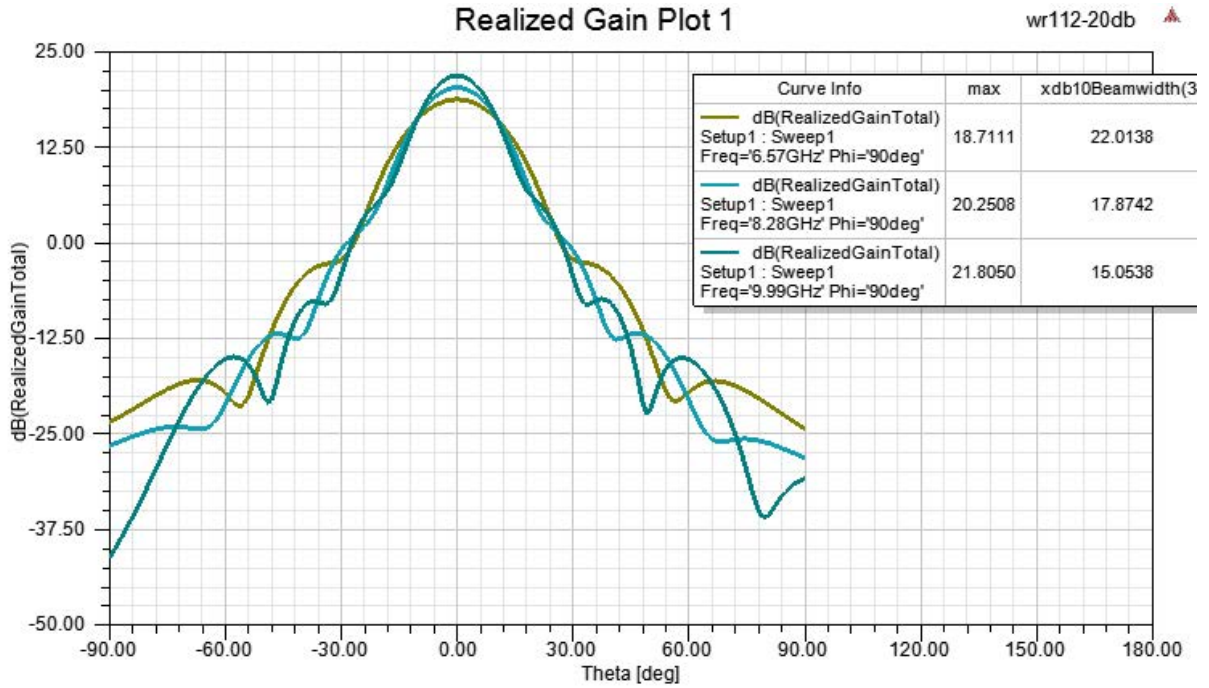

WR-112 Standard Gain Horn with 20 dBi gain, End Launch N Female connector from Pasternack Enterprises has same day shipment for domestic and International orders. Our RF, microwave and millimeter wave products maintain a 99.4% availability and are part of the broadest selection in the industry.

Click the following link (or enter part number in "SEARCH" on website) to obtain additional part information including price, inventory and certifications: [WR-112 Standard Gain Horn with 20 dBi gain, End Launch N Female connector PEWAN112-20ELNF](#)

URL:

The information contained in this document is accurate to the best of our knowledge and representative of the part described herein. It may be necessary to make modifications to the part and/or the documentation of the part, in order to implement improvements. Pasternack reserves the right to make such changes as required. Unless otherwise stated, all specifications are nominal. Pasternack does not make any representation or warranty regarding the suitability of the part described herein for any particular purpose, and Pasternack does not assume any liability arising out of the use of any part or documentation.

# PEWAN112-20ELNF CAD Drawing

WR-112 Standard Gain Horn with 20 dBi gain, End Launch N Female connector

REVISIONS			
REV.	DESCRIPTION	DATE	APPROVED
A	INITIAL RELEASE	01/11/2022	KHIETPAS

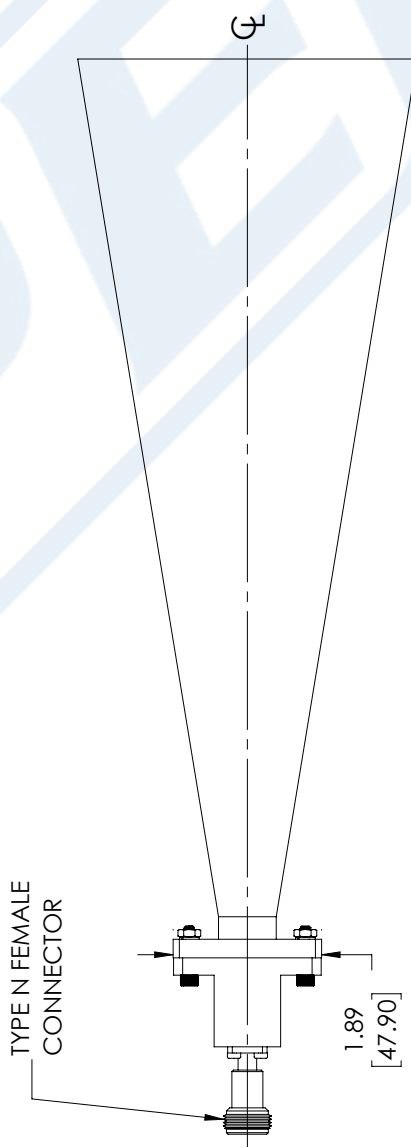
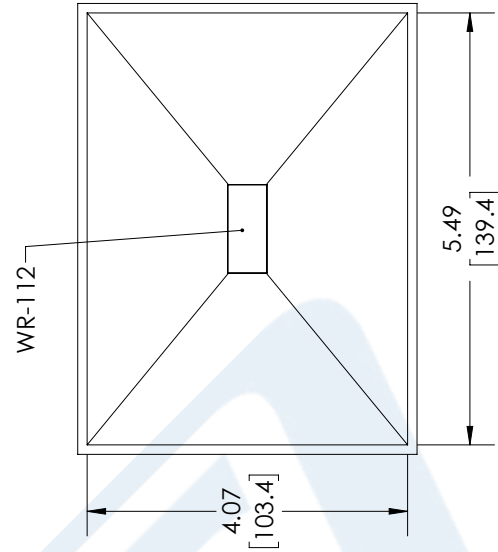
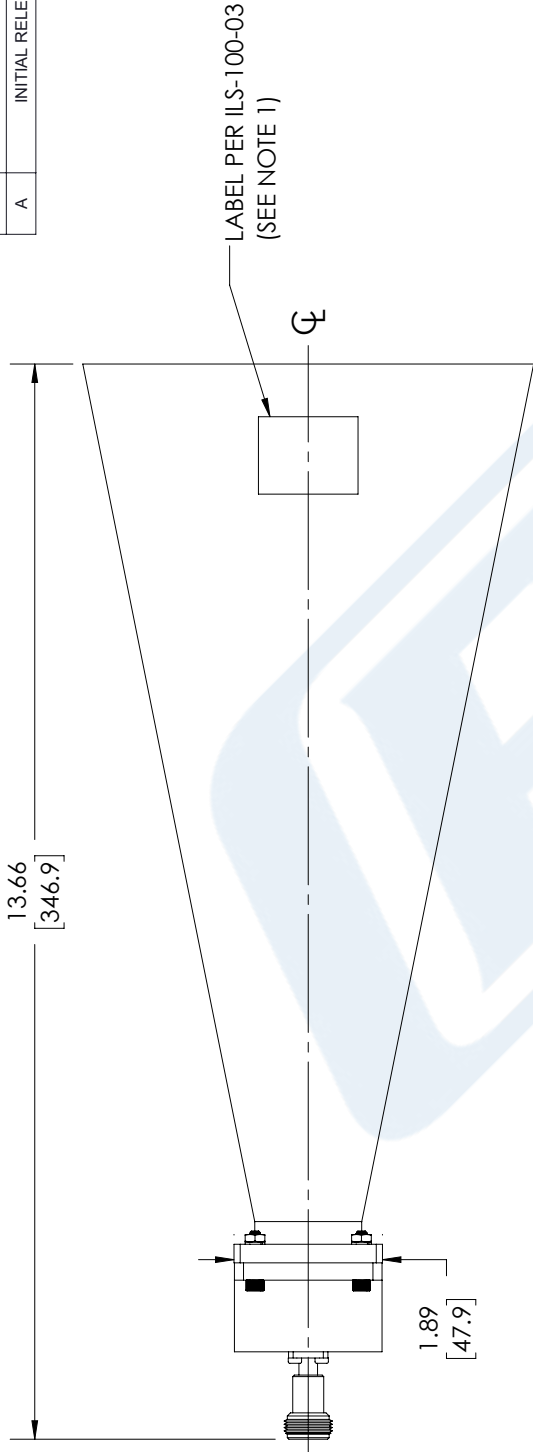

<p>THE INFORMATION AND DESIGN IN THIS DOCUMENT IS THE PROPERTY OF PASTERNAK CORPORATION ALL RIGHTS RESERVED.</p>	SHEET 1 OF 1
	SCALE N/A
<p>Pasternack Enterprises, Inc.                  P. O. Box 16759, Irvine, CA 92623.                  Phone: 1.949.261.1920   1.866.727.8376                  Fax: 1.949.261.7451                  Website: www.pasternack.com                  E-mail: sales@pasternack.com</p>	
UNLESS OTHERWISE SPECIFIED LEADING DIMENSIONS ARE INCHES DIMENSIONS IN [ ] ARE MILLIMETERS	TOLERANCES: .X = ±.2 [5.08] FRACTIONS ±.1/32 .XX = ±.02 [.51] ±.1/32 .XXX = ±.005 [.13] ANGLES ± 1° CABLE LENGTH (L) TOLERANCES: L ≤ 12 [305] = +1 [25] / -0 12 [305] < L ≤ 60 [1524] = +2 [51] / -0 60 [1524] < L ≤ 120 [3048] = +4 [102] / -0 120 [3048] < L ≤ 300 [7620] = +6 [152] / -0 300 [7620] < L = +5%L / -0
ALL DIMENSIONS SHOWN ARE FOR REFERENCE ONLY.	ITEM NO. PEWAN112-20ELNF REV A

- NOTES:**
- LABEL PER ILS-100-03 (FOR INTERNAL REFERENCE ONLY)  
 LABEL LOCATION FOR REFERENCE ONLY

THESE COMMODITIES, TECHNOLOGY OR SOFTWARE WERE EXPORTED FROM THE UNITED STATES IN ACCORDANCE WITH THE EXPORT ADMINISTRATION REGULATIONS. DIVERSION CONTRARY TO U.S. LAW PROHIBITED.