

Intel® Solid State Drive E 5400s Series (2.5-inch)

Product Specification

- Capacities: 80, 120, 180 GB
- Form Factors: 2.5-inch
- Thickness: 7 mm
- Weight: Up to 58 grams
- SATA 6Gb/s Bandwidth Performance^{1,2}
(IOMeter* Queue Depth 32)
 - Sequential Read: up to 560MB/s
 - Sequential Write: up to 475MB/s
- Read and Write IOPS^{1,2}
(IOMeter Queue Depth 32)
 - Random 4KB Reads: up to 71,000 IOPS
 - Random 4KB Writes: up to 85,000 IOPS^{1,2}
- Intel® Stable Image Platform Program (SIPP)
- Security and Manageability Compatibility
 - Intel® Core™ vPro™ Processor
 - Intel® Setup and Configuration Software (Intel® SCS)
 - AES 256-bit Encryption
- Additional Compatibility
 - Intel® SSD Toolbox with Intel® SSD Optimizer
 - Intel® Data Migration Software
 - Intel® Rapid Storage Technology
 - SATA Revision 3.2
 - ACS-3 (ATA/ATAPI Command Set 3)
 - SSD Enhanced SMART ATA feature set
- Power Management
 - 5.0 V SATA Supply Rail
 - SATA Link Power Management (LPM)
 - Device Sleep (DevSleep)
 - Advanced Power Management (APM)
- Power
 - Active (BAPCo MobileMark* 2012 Workload): 90 mW
 - Idle³: 50mW
 - DevSleep: 5 mW
- Temperature
 - Operating⁴: 0° C to 70° C
 - Non-Operating: -55° C to 95° C
- Reliability
 - Uncorrectable Bit Error Rate (UBER): <1 sector per 10¹⁶ bits read
 - Mean Time Between Failure (MTBF): 1.6 million hours
 - Shock (operating and non-operating): 1,500 G/0.5 ms
- Vibration
 - Operating: 2.17 GRMS (5-700Hz)
 - Non-operating: 3.13 GRMS (5-800Hz)
- Certifications and Declarations:
 - UL*
 - CE*
 - RCM*
 - BSMI*
 - KCC*
 - Microsoft* WHCK / WHLK
 - VCCI*
 - SATA-IO*
- Product Ecological Compliance
 - RoHS*

NOTES:

1. **IOMeter Test and System Configurations:** Intel® Core™ i7-4790 (8MB L3 Cache, 3.60GHz), ASUS* Deluxe Z971-PLUS motherboard, Intel® HD Graphics 4600 driver 10.18.10.3920, BIOS: AMI* 2605 5/19/2015, Chipset: Intel® INF 10.0.16.0, Memory: 8GB (2X4GB) Kingston DDR3-1555, Intel® RST driver 13.5, Microsoft* Windows 7 Enterprise 64-bit with SP1.
2. Performance values vary by capacity.
3. Non-DevSleep idle power with SATA Link Power Management (LPM) enabled.
4. As measured by temperature sensor, SMART Attribute BEh. Active airflow is recommended within the system for maintaining proper device operating temperatures on heavier workloads.

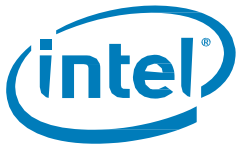

Ordering Information

Contact your local Intel sales representative for ordering information.

Revision History

Revision Number	Description	Revision Date
001	• Initial release	March 2016

Tests document performance of components on a particular test, in specific systems. Differences in hardware, software, or configuration will affect actual performance. Consult other sources of information to evaluate performance as you consider your purchase.

For more complete information about performance and benchmark results, visit <http://www.intel.com/performance>.

IOMeter Test and System Configurations: Intel® Core™ i7-4790 (8MB L3 Cache, 3.60GHz), ASUS* Deluxe Z97I-PLUS motherboard, Intel® HD Graphics 4600 driver 10.18.10.3920, BIOS: AMI* 2605 5/19/2015, Chipset: Intel® INF 10.0.16.0, Memory: 8GB (2X4GB) Kingston DDR3-1555, Intel® RST driver 13.5, Microsoft* Windows 7 Enterprise 64-bit with SP1.

All documented test results are obtained by Intel in compliance with JESD218 Standards; refer to individual sub-sections within this document for specific methodologies. See www.jedec.org for detailed definitions of JESD218 Standards.

Low Halogen applies only to brominated and chlorinated flame retardants (BFRs/CFRs) and PVC in the final product. Intel components as well as purchased components on the finished assembly meet JS-709 requirements, and the PCB/substrate meet IEC 61249-2-21 requirements. The replacement of halogenated flame retardants and/or PVC may not be better for the environment.

Intel disclaims all express and implied warranties, including without limitation, the implied warranties of merchantability, fitness for a particular purpose, and non-infringement, as well as any warranty arising from course of performance, course of dealing, or usage in trade.

The products described in this document may contain design defects or errors known as errata which may cause the product to deviate from published specifications. Current characterized errata are available on request.

Contact your local Intel sales office or your distributor to obtain the latest specifications and before placing your product order. This document contains information on products in the design phase of development.

Copies of documents which have an order number and are referenced in this document, or other Intel literature, may be obtained by calling 1-800-548-4725, or go to: <http://www.intel.com/design/literature.htm>

Intel, Intel Core i7-4790, Intel HD Graphics 4600 Driver, Intel INF, Intel RST and the Intel logo are trademarks of Intel Corporation in the U.S. and other countries.

*Other names and brands may be claimed as the property of others.

Copyright © 2016 Intel Corporation. All rights reserved.

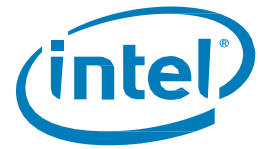

Contents

1	Introduction	5
1.1	Terminology	5
1.2	Reference Documents.....	6
2	Product Specifications.....	7
2.1	Capacity	7
2.2	Performance	7
2.3	Electrical Characteristics	8
2.4	Environmental Conditions	9
2.4.1	Temperature, Shock, Vibration	9
2.4.2	Altitude.....	9
2.5	Product Regulatory Compliance	10
2.6	Reliability.....	10
2.7	Hot Plug Support.....	10
3	Mechanical Information	11
4	Pin and Signal Descriptions.....	12
4.1	Pin Locations.....	12
4.2	Signal Descriptions.....	12
4.2.1	Connector Pin Signal Definitions	12
4.2.2	Power Pin Signal Definitions.....	13
5	Supported Command and Feature Sets.....	14
5.1	Supported ATA General Feature Command Set.....	14
5.2	Security Features.....	16
5.2.1	Sanitization Methods.....	16
5.3	DevSleep	17
5.4	SMART Attributes.....	18
6	Certificates and Declarations	21
7	Appendix	22
7.1	Identify Device.....	22
7.2	Models.....	25

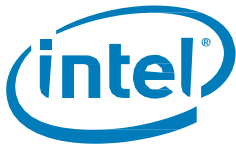

Tables

Table 1:	Terminology.....	5
Table 2:	Standard References	6
Table 3:	User Addressable Sectors	7
Table 4:	Burst Performance.....	7
Table 5:	Sustained Performance	7
Table 6:	Latency	8
Table 7:	Operating Voltage and Power Consumption	8
Table 8:	Temperature, Shock, Vibration	9
Table 9:	Reliability Specifications	10
Table 10:	Serial ATA Connector Pin Definitions	12
Table 11:	Serial ATA Power Pin Definitions.....	13
Table 12:	Supported ATA Commands and Feature Sets.....	14
Table 13:	Supported Secure Erase Modes and Definitions.....	16
Table 14:	Supported Sanitize Device Modes and Definitions	16
Table 16:	DevSleep Control Parameters.....	17
Table 17:	SMART Attributes.....	18
Table 18:	SMART Attribute Status Flags	20
Table 19:	Device Certifications and Declarations.....	21
Table 20:	Identify Device Returned Sector Data.....	22
Table 21:	Available Models	25

Figures

Figure 1:	Dimensions for Full Size 2.5 inch Drives	11
Figure 2:	Layout of Signal and Power Segment Pins.....	12

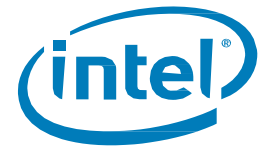

1 Introduction

This document describes the specifications and capabilities of the Intel® Solid State Drive E 5400s Series (Intel® SSD E 5400s Series).

1.1 Terminology

Table 1: Terminology

Term	Description
AHCI*	Advanced Host Controller Interface
APM	Advanced Power Management
ATA	Advanced Technology Attachment
DAS	Device Activity Signal
DevSleep	Device Sleep
DIPM	Device Initiated Power Management
DMA	Direct Memory Access
DPTF	Dynamic Platform Thermal Framework
EXT	Extended
FPDMA	First Party Direct Memory Access
GB	Gigabyte (1,000,000,000 bytes) Note: The total usable capacity of the SSD may be less than the total physical capacity because a small portion of the capacity is used for NAND flash management and maintenance purposes.
HDD	Hard Disk Drive
HIPM	Host Initiated Power Management
I/O	Input/Output
IOPS	Input/Output Operations Per Second
KB	Kilobyte (1,024 bytes)
LBA	Logical Block Address
LPM	Link Power Management
MB	Megabyte (1,000,000 bytes)
MLC	Multi-level Cell
MTBF	Mean Time Between Failures
NCQ	Native Command Queuing
NOP	No Operation
PIO	Programmed Input/Output

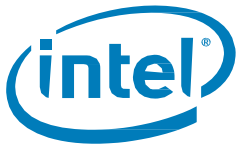

Term	Description
RDT	Reliability Demonstration Test
RMS	Root Mean Squared
SLC	Single-level Cell
SATA	Serial Advanced Technology Attachment
SED	Self-Encrypting Drive
SMART	Self-Monitoring, Analysis and Reporting Technology
SSD	Solid State Drive
TYP	Typical
UBER	Uncorrectable Bit Error Rate

1.2 Reference Documents

Table 2: Standard References

Date or Rev. #	Title	Location
May 2005	SFF-8201, 2.5-inch drive form factor	http://www.sffcommittee.org/
May 2006	SFF-8223, 2.5-inch Drive w/Serial Attachment Connector	http://www.sffcommittee.org/
Sept 2008	IEC 55022 Information Technology Equipment — Radio disturbance Characteristics— Limits and methods of measurement CISPR22:2008 (Modified)	http://www.iec.ch/
Dec 2008	VCCI	http://www.vcci.jp/vcci_e/
June 2009	RoHS	http://qdms.intel.com/ Click Search MDDS Database and search for material description datasheet
August 2010	IEC 55024 Information Technology Equipment — Immunity characteristics— Limits and methods of measurement CISPR24:2010	http://www.iec.ch/
Sept 2010	Solid State Drive (SSD) Requirements and Endurance Test Method (JESD218)	http://www.jedec.org/standards-documents/docs/jesd218/
August 2013	Serial ATA Revision 3.2	http://www.sata-io.org/
October 2013	ACS-3 Specification	http://www.t13.org/

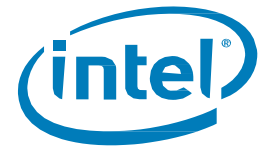

2 Product Specifications

2.1 Capacity

Table 3: User Addressable Sectors

Capacity	Unformatted Capacity (Total User Addressable Sectors in LBA mode)
80GB	156,301,488
120GB	234,441,648
180GB	351,651,888

2.2 Performance

Table 4: Burst Performance

Capacity	Random 4KB Read (up to) ¹	Random 4KB Write (up to) ¹	Sequential 128KB Read ¹	Sequential 128KB Write ¹
	IOPS	IOPS	MB/s	MB/s
80GB	55,000	45,000	560	300
120GB	60,000	50,000	560	400
180GB	71,000	85,000	560	475

NOTES:

- Performance measured within the SLC cache buffer using IOMeter* with Queue Depth 32.

Table 5: Sustained Performance

Capacity	Specification			
	Random 4KB Read (up to) ¹	Random 4KB Write (up to) ¹	Sequential 128KB Read ¹	Sequential 128KB Write ¹
	IOPS	IOPS	MB/s	MB/s
80GB	45,000	13,000	560	50
120GB	55,000	13,500	560	70
180GB	65,000	22,000	560	90

Note:

- Performance measured using IOMeter* with Queue Depth 32. Measurements are performed on 8GB of Logical Block Address (LBA) range on a full SSD.

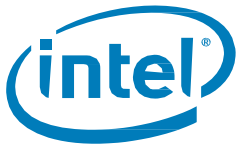

Table 6: Latency

Specification	Intel® SSD E 5400s Series (All Capacities)
Power On To Ready ¹	500 ms (TYP)
Max Power On To Ready ²	< 10 sec

NOTES:

1. Power On To Ready time assumes safe shutdown.
2. Max Power On To Ready time assumes unsafe shutdown. Based on statistical measurement of 95% quality of service.

2.3 Electrical Characteristics

Table 7: Operating Voltage and Power Consumption

Electrical Characteristics	Value		
	80GB	120GB	180GB
Operating Voltage for 5 V (±5%)	4.75 V		
Min	5.25 V		
Max	100 ms / 0.1 ms		
Rise Time (Max/Min)	5 s / 1 ms		
Fall Time (Max/Min)	100 mV pp (10 Hz – 30 MHz)		
Noise Tolerance	1 s		
Min Off Time ¹			
Power Consumption (TYP)	90 mW		
Active ²	50 mW		
Idle ³	5 mW		
DevSleep ⁴			
Thermal Power ⁵	2.3	2.7	2.8
Regulator Power ⁶	2.5	3	3.1

NOTES:

1. Minimum time from when power removed from drive (Vcc < 100 mV) to when power can be reapplied to drive.
2. Active power measured during execution of MobileMark* 2012 with SATA Link Power Management (LPM) enabled.
3. Non-DevSleep idle power with SATA Link Power Management (LPM) enabled.
4. Power consumption during DevSleep state.
5. Power measured during 128kB sequential writes with Queue Depth 32 workload using 100 ms sample period. This represents power that would be thermal load on system during heavy workloads.
6. Power measured during 128kB sequential writes with Queue Depth 32 workload using 500 us sample period. This represents power that system power supply would have to regulate for proper device operation.

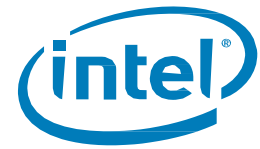

2.4 Environmental Conditions

2.4.1 Temperature, Shock, Vibration

Table 8: Temperature, Shock, Vibration

Electrical Characteristics	Range
Case Temperature Operating Non-operating ¹	0° C – 70° C -55° C – 95° C
Temperature Gradient ² Operating Non-operating	30 (TYP)° C/hr 30 (TYP)° C/hr
Humidity Operating Non-operating	5 – 95 % 5 – 95 %
Shock and Vibration	Range
Shock ³ Operating Non-operating	1,500 G (Max) at 0.5 msec 1,500 G (Max) at 0.5 msec
Vibration ⁴ Operating Non-operating	2.17 GRMS (5-700 Hz) Max 3.13 RMS (5-800 Hz) Max

NOTES:

1. Please contact your Intel representative for details on the non-operating temperature range.
2. Temperature gradient measured without condensation.
3. Shock specifications assume SSD is mounted securely with the input vibration applied to the drive-mounting screws. Stimulus may be applied in the X, Y or Z axis. Shock specification is measured using peak acceleration and pulse width value.
4. Vibration specifications assume the SSD is mounted securely with the input vibration applied to the drive-mounting screws. Stimulus may be applied in the X, Y or Z axis. Vibration specification is measured using G Root Mean Squared (GRMS) value.

2.4.2 Altitude

The drive is not sensitive to changes in atmospheric pressure because it has no moving parts. Drive tested under non-operational conditions to pressures representative of -1 K and +40 K feet.

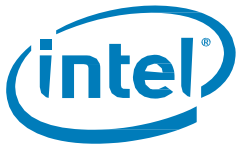

2.5 Product Regulatory Compliance

The Intel SSD E 5400s Series meets or exceeds the regulatory or certification requirements as specified in the Intel SSD E 5400s Series Declaration of Conformity at: <http://www.intel.com/content/www/us/en/library/tech-docs.results.html?mTag=rresourceType:technicaldocument/declarationofconformity>

2.6 Reliability

The Intel® SSD E 5400s Series meets or exceeds SSD endurance and data retention requirements as specified in the JESD218 specification.

Table 9: Reliability Specifications

Parameter	Value
Uncorrectable Bit Error Rate (UBER) Uncorrectable bit error rate will not exceed one sector in the specified number of bits read. In the unlikely event of a non-recoverable read error, the SSD will report it as a read failure to the host; the sector in error is considered corrupt and is not returned to the host.	< 1 sector per 10 ¹⁶ bits read
Mean Time Between Failures (MTBF) Mean Time Between Failures is estimated based on Telcordia* methodology and demonstrated through Reliability Demonstration Test (RDT).	≥ 1.6 million hours
Minimum Useful Life/Endurance Rating The SSD will have a minimum of five years of useful life under typical client workloads with up to 20 GB of host writes per day.	5 years
Insertion Cycles Maximum insertion/removal cycles on 2.5-inch port	250 insertion/removal cycles

2.7 Hot Plug Support

Hot Plug insertion and removal is supported in the presence of a proper connector and appropriate operation system, as described in the SATA 3.2 specification.

This product supports asynchronous signal recovery and issues an unsolicited COMINIT when first mated with a powered connector to enable detection by a host system without hardware device detection.

3 Mechanical Information

The figure below shows the mechanical information for the full size 2.5 inch Intel® SSD E 5400s Series. All dimensions are in millimeters.

Figure 1: Dimensions for Full Size 2.5 inch Drives

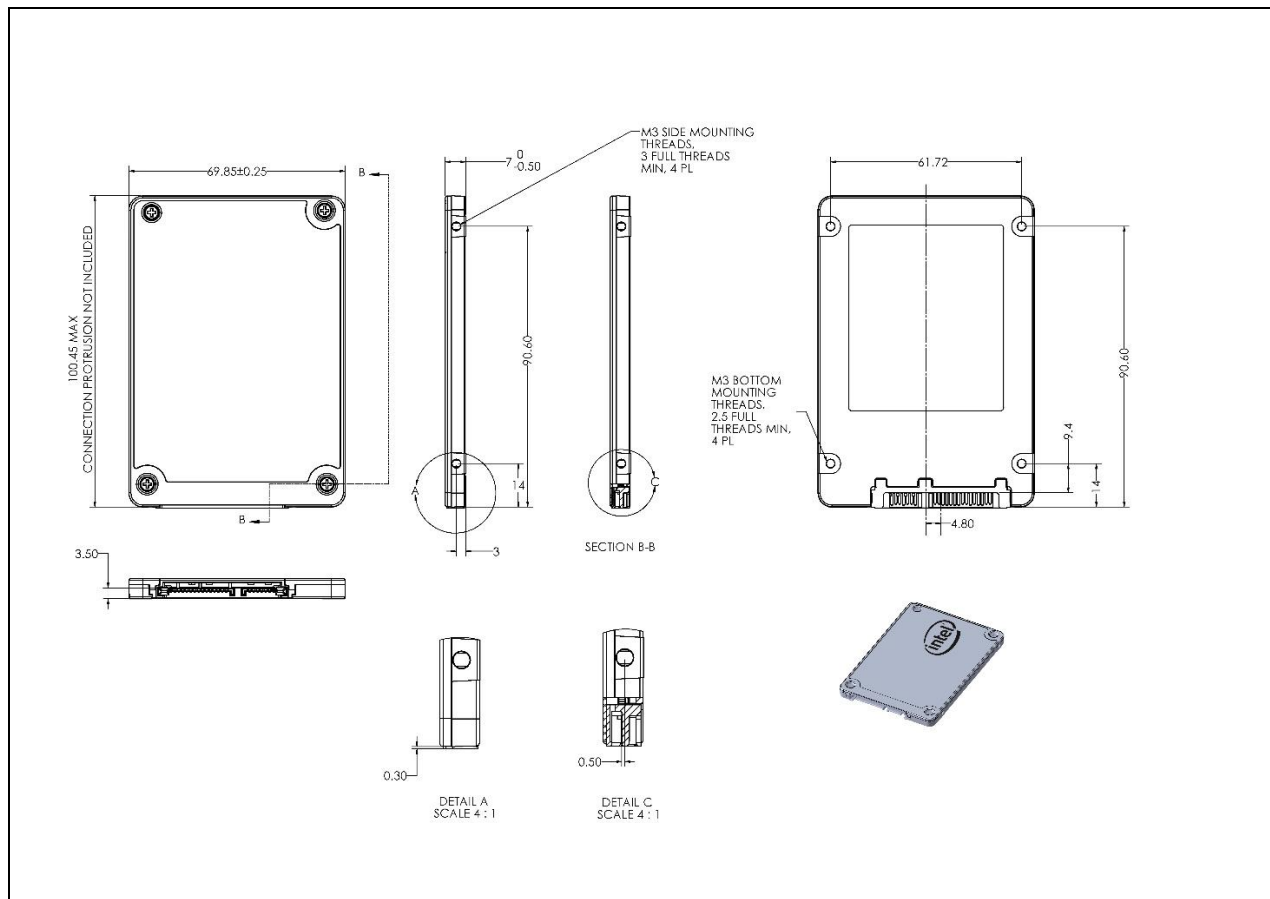

4 Pin and Signal Descriptions

4.1 Pin Locations

Figure 2: Layout of Signal and Power Segment Pins

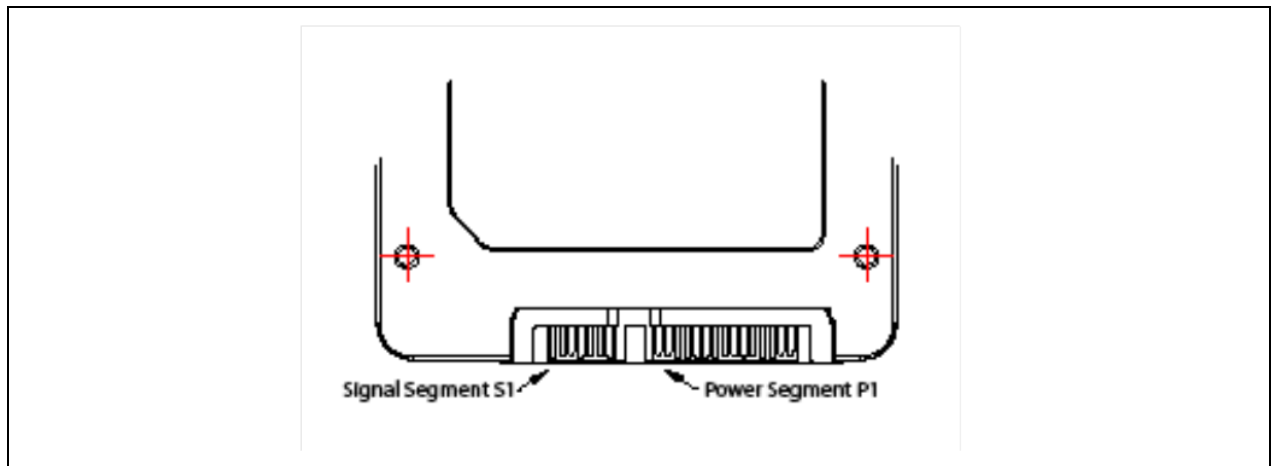

4.2 Signal Descriptions

4.2.1 Connector Pin Signal Definitions

Table 10: Serial ATA Connector Pin Definitions

Pin	Function	Definition
S1	Ground	1st mate
S2	A+	Differential signal pair A
S3	A-	
S4	Ground	1st mate
S5	B-	Differential signal pair B
S6	B+	
S7	Ground	1st mate

Note: Key and spacing separate signal and power segments.

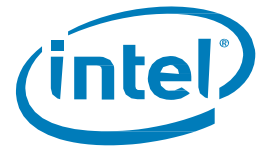

4.2.2 Power Pin Signal Definitions

Table 11: Serial ATA Power Pin Definitions

Pin ¹	Name	Definition	Mating Order
P1 ²	V ₃₃	3.3 V Power; not used	2nd Mate
P2 ²	V ₃₃	3.3 V Power; not used	2nd Mate
P3	DevSleep	Device Sleep Pin	1st Mate
P4 ^{3,4}	Ground		1st Mate
P5 ³	Ground		1st Mate
P6 ³	Ground		1st Mate
P7 ^{3,5}	V ₅	5 V Power	1st Mate
P8 ^{3,5}	V ₅	5 V Power	2nd Mate
P9 ^{3,5}	V ₅	5 V Power	2nd Mate
P10 ³	Ground		1st Mate
P11 ⁶	DAS	Device Activity Signal	2nd Mate
P12 ^{3,4}	Ground		1st Mate
P13 ²	V ₁₂	12 V Power; not used	1st Mate
P14 ²	V ₁₂	12 V Power; not used	2nd Mate
P15 ²	V ₁₂	12 V Power; not used	2nd Mate

NOTES:

1. All pins are in a single row, with a 1.27 mm (0.050-inch) pitch.
2. Pins P1 and P2 are connected together; Pins P13, P14 and P15 are connected together. Although they are not connected internally to the device, the host may apply voltage on these pins.
3. The mating sequence is:
 - Ground pins P4-P6, P10, P12 and the 5V power pin P7.
 - Signal pins and the rest of the 5V power pins P8-P9.
4. Ground connectors P4 and P12 may contact before the other 1st mate pins in both the power and signal connectors to discharge ESD in a suitably configured backplane connector.
5. Power pins P7, P8, and P9 are internally connected to one another within the device.
6. The host may ground P11 if it is not used for Device Activity Signal (DAS).

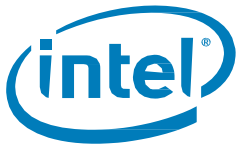

5 Supported Command and Feature Sets

The Intel® SSD E 5400s Series supports all mandatory Advanced Technology Attachment (ATA) and Serial ATA (SATA) commands defined in the ACS-3 and SATA Revision 3.2 specifications. The mandatory and optional commands are defined in this section.

5.1 Supported ATA General Feature Command Set

Below are mandatory and optional ATA feature sets supported by Intel SSD E 5400s Series.

- 48-Bit Address
- General
- General Purpose Logging (GPL)
- Native Command Queuing (NCQ)
- Power Management
- Sanitize Device
- Security
- SMART
- Software Settings Preservation (SSP)

Below are mandatory and optional ATA commands supported by Intel SSD E 5400s Series.

Table 12: Supported ATA Commands and Feature Sets

Commands	Feature Set
BLOCK ERASE EXT	Sanitize Device ¹
CHECK POWER MODE	Power Management
CRYPTO SCRAMBLE EXT	Sanitize Device ¹
DATA SET MANAGEMENT	ATA General Feature
DOWNLOAD MICROCODE	ATA General Feature
EXECUTE DEVICE DIAGNOSTIC	ATA General Feature
FLUSH CACHE	ATA General Feature
FLUSH CACHE EXT	48-Bit Address
IDENTIFY DEVICE ²	ATA General Feature
IDLE	Power Management
IDLE IMMEDIATE	Power Management
NOP	ATA General Feature
READ BUFFER	ATA General Feature
READ DMA	ATA General Feature
READ DMA EXT	48-Bit Address
READ FPDMA QUEUED	Native Command Queuing
READ LOG DMA EXT	General Purpose Logging
READ LOG EXT	General Purpose Logging

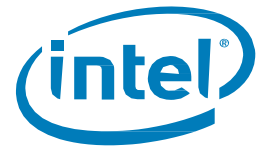

Commands	Feature Set
READ MULTIPLE	ATA General Feature
READ MULTIPLE EXT	48-Bit Address
READ NATIVE MAX ADDRESS	48-Bit Address
READ NATIVE MAX ADDRESS EXT	48-Bit Address
READ SECTOR(S)	ATA General Feature
READ SECTOR(S) EXT	48-Bit Address
READ VERIFY SECTOR(S)	ATA General Feature
READ VERIFY SECTOR(S) EXT	48-Bit Address
SANITIZE FREEZE LOCK EXT	Sanitize Device ¹
SANITIZE STATUS EXT	Sanitize Device ¹
SECURITY DISABLE PASSWORD	ATA Security ³
SECURITY ERASE PREPARE	ATA Security ³
SECURITY ERASE UNIT	ATA Security ³
SECURITY FREEZE LOCK	ATA Security ³
SECURITY SET PASSWORD	ATA Security ³
SECURITY UNLOCK	ATA Security ³
SEEK	ATA General Feature
SET FEATURES	ATA General Feature
SET MAX ADDRESS EXT	48-Bit Address
SET MULTIPLE MODE	ATA General Feature
SLEEP	Power Management
SMART DISABLE OPERATIONS	SMART
SMART ENABLE OPERATIONS	SMART
SMART ENABLE/DISABLE ATTRIBUTE AUTOSAVE	SMART
SMART EXECUTE OFF-LINE IMMEDIATE	SMART
SMART READ DATA	SMART
SMART READ ATTRIBUTE THRESHOLDS	SMART
SMART READ LOG	SMART
SMART READ LOG SECTOR	SMART
SMART RETURN STATUS	SMART
SMART SAVE ATTRIBUTE VALUES	SMART
SMART WRITE LOG SECTOR	SMART
STANDBY	Power Management
STANDBY IMMEDIATE	Power Management
WRITE BUFFER	ATA General Feature
WRITE DMA	ATA General Feature
WRITE DMA EXT	48-Bit Address

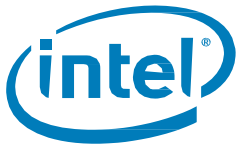

Commands	Feature Set
WRITE DMA FUA EXT	48-Bit Address
WRITE FPDMA QUEUED	Native Command Queuing
WRITE LOG DMA EXT	General Purpose Logging
WRITE LOG EXT	General Purpose Logging
WRITE MULTIPLE	ATA General Feature
WRITE MULTIPLE EXT	48-Bit Address
WRITE MULTIPLE FUA EXT	48-Bit Address
WRITE SECTOR(S)	ATA General Feature
WRITE SECTOR(S) EXT	48-Bit Address
WRITE UNCORRECTABLE EXT	ATA General Feature

NOTES:

1. See the Appendix for details on the sector data returned after issuing an IDENTIFY DEVICE command.

5.2 Security Features

5.2.1 Sanitization Methods

Sanitization refers to a process to render data inaccessible. Various sanitization methods are listed below.

5.2.1.1 Secure Erase

Secure Erase runs the SECURITY ERASE UNIT command

Table 13: Supported Secure Erase Modes and Definitions

Secure Erase Mode	Definition
Normal Mode	Full NAND erase of user available space and spare area
Enhanced Mode	Cryptographically erase data

Note: Secure Erase Modes are not supported if drive is in an Opal Activated state.

5.2.1.2 Sanitize Device

Table 14: Supported Sanitize Device Modes and Definitions

Mode	Definition
Block Erase	Block erase method, all user data areas including user data not currently allocated, irretrievable
Crypto Scramble Ext	Changes the internal encryption keys

Note: Sanitize Device Modes are not supported if drive is in an Opal Activated state.

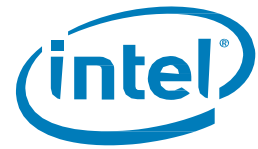

5.3 DevSleep

Intel SSD E 5400s Series supports the DevSleep feature. DevSleep must be enabled on the device by the host system through the SET FEATURES command. If DevSleep is enabled by the host, the host must drive the DevSleep signal to proper assert/de-assert voltage levels according to the SATA specification. Entry into DevSleep must be preceded by LPM slumber entry by host and device. The Intel SSD E 5400s Series also supports DevSleep_to_ReducedPwrState which allows the host to wake the drive using normal LPM COMWAKE out-of-band signaling.

For the Intel SSD E 5400s Series, the recommended total time to DevSleep for system active state is 6 sec. The AHCI* controller has 4 parameters used to define proper DevSleep operation between the host and drive. The following table provides those recommended values for the Intel SSD E 5400s Series drive.

Table 15: DevSleep Control Parameters

Parameter	Definition	Control	Recommended Settings
DITO	DevSleep Idle Time Out – number of milliseconds prior to host asserting DevSleep	Set by Host	Active (lid-up): 375
DM	DITO Multiplier – set once at boot-up	Set by Host	15
MDAT	Minimum DevSleep Assertion Time – minimum time in milliseconds for host to assert DevSleep	Reported by Drive	10
DETO	DevSleep Exit Time Out – max time in milliseconds from when DevSleep is negated to when device ready to detect OOB	Reported by Drive	20

Total time to DevSleep entry – DITO * (DM+1)

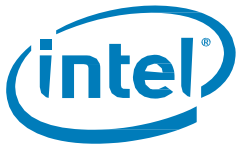

5.4 SMART Attributes

The following two tables list the SMART attributes supported by the Intel SSD E 5400s Series, and the corresponding status flags and threshold settings.

Table 16: SMART Attributes

ID	Attribute	Status Flags						Threshold
		SP	EC	ER	PE	OC	PW	
05h	<p>Re-allocated Sector Count</p> <p>The raw value of this attribute shows the number of retired blocks since leaving the factory (grown defect count).</p>	1	1	0	0	1	0	0 (none)
09h	<p>Power-On Hours Count</p> <p>The raw value reports the cumulative number of power-on hours over the life of the device,</p> <p>The On/Off status of the Device Initiated Power Management (DIPM) and Devsleep features will affect the number of hours reported. If DIPM and/or Devsleep are turned On, the recorded value for power-on hours does not include the time that the device is in those states.</p>	1	1	0	0	1	0	0 (none)
0Ch	<p>Power Cycle Count</p> <p>The raw value of this attribute reports the cumulative number of power cycle events over the life of the device.</p>	1	1	0	0	1	0	0 (none)
AAh	Available Reserved Space (See E8h Attribute)	1	1	0	0	1	1	10
ABh	<p>Program Fail Count</p> <p>The raw value of this attribute shows total count of program fails and the normalized value, beginning at 100, shows the percent remaining of allowable program fails.</p>	1	1	0	0	1	0	0 (none)
ACh	<p>Erase Fail Count</p> <p>The raw value of this attribute shows total count of erase fails and the normalized value, beginning at 100, shows the percent remaining of allowable erase fails.</p>	1	1	0	0	1	0	0 (none)
AEh	<p>Unexpected Power Loss</p> <p>The raw value of this attribute reports the cumulative number of unsafe (unclean) shutdown events over the life of the device. An unsafe shutdown occurs whenever the device is powered off without STANDBY IMMEDIATE being the last command</p>	1	1	0	0	1	0	0 (none)
B7h	<p>SATA Downshift Count</p> <p>The raw value counts of the number of times SATA interface selected lower signaling rate due to error.</p>	1	1	0	0	1	0	0

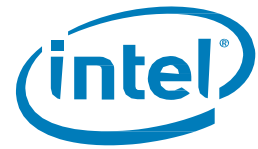

Intel® Solid State Drive E 5400s Series (2.5-inch)

ID	Attribute	Status Flags						Threshold
		SP	EC	ER	PE	OC	PW	
B8h	End-to-End Error Detection Count Reports number of errors encountered during end-to-end error detection within the SSD data path.	1	1	0	0	1	1	90
BBh	Uncorrectable Error Count The raw value shows the count of errors that could not be recovered using Error Correction Code (ECC) and XOR	1	1	0	0	1	0	0 (none)
BEh	Temperature Reports real-time temperature of drive as measured by temperature sensor on drive PCB. The normalized value reports the current temperature value. The raw value shows current, lifetime highest and lifetime lowest temperatures. Byte 1:0 = current temp Celsius; Byte 3:2 = lifetime highest temp Celsius; Byte 5:4 = lifetime lowest temp Celsius.	1	1	0	0	1	0	0 (none)
C0h	Power-Off Retract Count (Unsafe Shutdown Count) The raw value of this attribute reports the cumulative number of unsafe (unclean) shutdown events over the life of the device. An unsafe shutdown occurs whenever the device is powered off without STANDBY IMMEDIATE being the last command.	1	1	0	0	1	0	0 (none)
C7h	CRC Error Count The total number of encountered SATA interface cyclic redundancy check (CRC) errors.	1	1	0	0	1	0	0 (none)
E1h	Host Writes The raw value of this attribute reports the total number of sectors written by the host system. The raw value is increased by 1 for every 65,536 sectors (32MB) written by the host.	1	1	0	0	1	0	0 (none)
E2h	Timed Workload Media Wear Measures the wear seen by the SSD (since reset of the workload timer, attribute E4h), as a percentage of the maximum rated cycles. Divide raw value by 1024 to get percentage of wear – accurate to 3 decimal places.	1	1	0	0	1	0	0 (none)
E3h	Timed Workload Host Read/Write Ratio The raw value shows the percentage of I/O operations that are read operations (since reset of the workload timer, attribute E4h).	1	1	0	0	1	0	0 (none)
E4h	Timed Workload Timer The raw value measures the elapsed time (number of minutes since starting this workload timer).	1	1	0	0	1	0	0 (none)
E8h	Available Reserved Space This attribute reports the number of reserve blocks remaining. The normalized value begins at 100 (64h), which corresponds to 100 percent availability of the reserved space. The threshold value for this attribute is 10 percent availability.	1	1	0	0	1	1	10
E9h	Media Wearout Indicator This attribute reports the number of cycles the NAND media has undergone. The normalized value	1	1	0	0	1	0	0 (none)

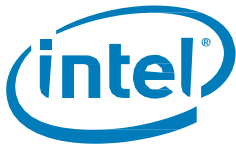

ID	Attribute	Status Flags						Threshold
		SP	EC	ER	PE	OC	PW	
	declines linearly from 100 to 1 as the average erase cycle count increases from 0 to the maximum rated cycles. Once the normalized value reaches 1, the number will not decrease, although it is likely that significant additional wear can be put on the device							
F1h	Total LBAs Written The raw value of this attribute reports the total number of sectors written by the host system. The raw value is increased by 1 for every 65,536 sectors (32MB) written by the host.	1	1	0	0	1	0	0 (none)
F2h	Total LBAs Read The raw value of this attribute reports the total number of sectors read by the host system. The raw value is increased by 1 for every 65,536 sectors (32MB) read by the host.	1	1	0	0	1	0	0 (none)
F9h	Total NAND Writes Raw value reports the number of writes to NAND in 1 GB increments.	1	1	0	0	1	0	0 (none)

Table 17: SMART Attribute Status Flag Descriptions

Status Flag	Description	Value = 0	Value = 1
SP	Self-preserving attribute	Not a self-preserving attribute	Self-preserving attribute
EC	Event count attribute	Not an event count attribute	Event count attribute
ER	Error rate attribute	Not an error rate attribute	Error rate attribute
PE	Performance attribute	Not a performance attribute	Performance attribute
OC	Online collection attribute	Collected only during offline activity	Collected during both offline and online activity
PW	Pre-fail warranty attribute	Advisory	Pre-fail

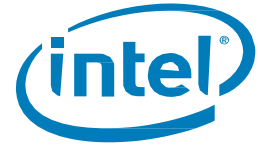

6 Certificates and Declarations

The following table describes the Device Certifications supported by the Intel SSD E 5400s Series.

Table 18: Device Certifications and Declarations

Certification	Description
CE* Compliant	European Economic Area (EEA): Compliance with the essential requirements of EC Council Directives Low Voltage Directive (LVD) 2006/95/EC, EMC Directive 2004/108/EC and Directive 2011/65/EU.
UL* Certified	Certified Underwriters Laboratories, Inc. Bi-National Component Recognition; UL 60950-1, 2nd Edition, 2007-03-27 (Information Technology Equipment - Safety - Part 1: General Requirements) CSA C22.2 No. 60950-1-07, 2nd Edition, 2007-03 (Information Technology Equipment - Safety - Part 1: General Requirements)
RCM* Compliant	Compliance with the Australia/New Zealand Standard AS/NZS3548 and Electromagnetic Compatibility (EMC) Framework requirements of the Australian Communication Authority (ACA).
BSMI* Compliant	Compliance to the Taiwan EMC standard CNS 13438: Information technology equipment - Radio disturbance Characteristics - limits and methods of measurement, as amended on June 1, 2006, is harmonized with CISPR 22: 2005.04.
KCC*	Compliance with paragraph 1 of Article 11 of the Electromagnetic Compatibility Control Regulation and meets the Electromagnetic Compatibility (EMC) Framework requirements of the Radio Research Laboratory (RRL) Ministry of Information and Communication Republic of Korea.
Microsoft* WHCK / WHLK	Microsoft Windows Hardware Certification
RoHS* Compliant	Restriction of Hazardous Substance Directive
VCCI*	Voluntary Control Council for Interface to cope with disturbance problems caused by personal computers or facsimile.
SATA-IO*	Indicates certified logo program from Serial ATA International Organization.
Low Halogen	Applies only to brominated and chlorinated flame retardants (BFRs/CFRs) and PVC in the final product. Intel components as well as purchased components on the finished assembly meet JS-709 requirements, and the PCB/substrate meet IEC 61249-2-21 requirements. The replacement of halogenated flame retardants and/or PVC may not be better for the environment.

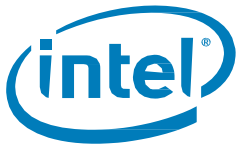

7 Appendix

7.1 Identify Device

The table below describes the sector data returned from an identify device command

Table 19: Identify Device Returned Sector Data

Word	F = Fixed V = Variable X = Both	Default Value	Description
0	F	0040h	General configuration bit-significant information
1	X	3FFFh	Obsolete - Number of logical cylinders (16,383)
2	V	C837h	Specific configuration
3	X	0010h	Obsolete - Number of logical heads (16)
4-5	X	0h	Retired
6	X	003Fh	Obsolete - Number of logical sectors per logical track (63)
7-8	V	0h	Reserved for assignment by the CompactFlash* Association (CFA)
9	X	0h	Retired
10-19	F	varies	Serial number (20 ASCII characters)
20-21	X	0h	Retired
22	X	0h	Obsolete
23-26	F	varies	Firmware revision (8 ASCII characters)
27-46	F	varies	Model number (Intel Solid State Drive)
47	F	8010h	7:0—Maximum number of sectors transferred per interrupt on multiple commands
48	F	4000h	Reserved
49	F	2F00h	Capabilities
50	F	4000h	Capabilities
51-52	X	0h	Obsolete
53	F	0007h	Words 88 and 70:64 valid
54	X	3FFFh	Obsolete - Number of logical cylinders (16,383)
55	X	0010h	Obsolete - Number of logical heads (16)
56	X	003Fh	Obsolete - Number of logical sectors per logical track (63)
57-58	X	00FBFC10h	Obsolete
59	V	B110h	Sanitize/Multiple Sector settings

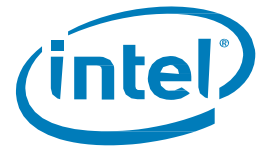

Intel® Solid State Drive E 5400s Series (2.5-inch)

Word	F = Fixed V = Variable X = Both	Default Value	Description
60-61	F	varies	Total number of user-addressable sectors
62	X	0h	Obsolete
63	F	0007h	Multi-word DMA modes supported/selected
64	F	0003h	PIO modes supported
65	F	0078h	Minimum multiword DMA transfer cycle time per word
66	F	0078h	Manufacturer's recommended multiword DMA transfer cycle time
67	F	0078h	Minimum PIO transfer cycle time without flow control
68	F	0078h	Minimum PIO transfer cycle time with IORDY flow control
69	F	4D10h	Additional Supported
70	F	0h	Reserved
71-74	F	0h	Reserved for IDENTIFY PACKET DEVICE command
75	F	001Fh	Queue depth
76	F	070Eh	Serial ATA capabilities
77	F	0086h	Reserved for future Serial ATA definition
78	F	014Ch	Serial ATA features supported
79	V	0040h	Serial ATA features enabled
80	F	07FCh	Major version number
81	F	FFFFh	Minor version number
82	F	746Bh	Command set supported
83	F	7409h	Command sets supported
84	F	6163h	Command set/feature supported extension
85	V	7469h	Command set/feature enabled
86	V	B409h	Command set/feature enabled
87	V	6163h	Command set/feature default
88	V	407Fh	Ultra DMA Modes
89	F	0002h	Time required for security erase unit completion
90	F	0001h	Time required for enhanced security erase completion
91	V	00FEh	Current advanced power management value
92	V	FFFEh	Master Password Revision Code
93	F	0h	Hardware reset result: the contents of bits (12:0) of this word shall change only during the execution of a hardware reset



Word	F = Fixed V = Variable X = Both	Default Value	Description
94	V	0h	Vendor's recommended and actual acoustic management value
95	F	0h	Stream minimum request size
96	V	0h	Streaming transfer time - DMA
97	V	0h	Streaming access latency - DMA and PIO
98-99	F	0h	Streaming performance granularity
100-103	V	varies	Maximum user LBA for 48-bit address feature set
104	V	0h	Streaming transfer time - PIO
105	F	0008h	Maximum number of 512 byte blocks for DSM command
106	F	4000h	Physical sector size / logical sector size
107	F	0h	Inter-seek delay for ISO-7779 acoustic testing in microseconds
108-111	F	varies	Unique ID
112-115	F	0h	Reserved for world wide name extension to 128 bits
116	V	0h	Reserved for technical report
117-118	F	0h	Words per logical sector
119	F	401Ch	Supported settings
120	F	401Ch	Command set/feature enabled/supported
121-126	F	0h	Reserved
127	F	0h	Removable Media Status Notification feature set support
128	V	0021h	Security status
129-159	X	varies	Vendor-specific
160	F	0h	CompactFlash Association (CFA) power mode 1
161-167	X	0h	Reserved for assignment by the CFA
168	F	0003h (2.5")	Nominal Form Factor
169	X	0001h	Data set management Trim attribute support
170-173	F	0h	Additional Product Identifier
174-175	F	0h	Reserved
176-205	V	0h	Current media serial number
206	X	0039h	SCT Command Transport
207-208	X	0h	Reserved
209	X	4000h	Alignment of logical blocks within a physical block
210-211	X	0h	Write-Read-Verify Sector Count Mode 3 (DWord)

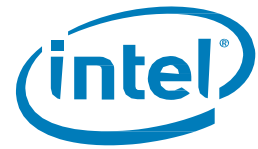

Word	F = Fixed V = Variable X = Both	Default Value	Description
212-213	X	0h	Write-Read-Verify Sector Count Mode 2 (DWord)
214	X	0h	NV Cache Capabilities
215-216	X	0h	NV Cache Size in Logical Blocks (DWord)
217	X	0001h	Nominal media rotation rate
218	X	0h	Reserved
219	X	0h	NV Cache Options
220	X	0h	Write-Read-Verify feature set
221	X	0h	Reserved
222	X	10FFh	Transport major version number
223	X	0h	Transport minor version number
224-229	X	0h	Reserved
230-233	X	0h	Extended Number of User Addressable Sectors (QWord)
234	X	0002h	Minimum number of 512-byte data blocks per DOWNLOAD MICROCODE command for mode 03h
235	X	0080h	Maximum number of 512-byte data blocks per DOWNLOAD MICROCODE command for mode 03h
236-254	X	0h	Reserved
255	X	varies	Integrity word

NOTES:

F = Fixed. The content of the word is fixed and does not change. For removable media devices, these values may change when media is removed or changed.

V = Variable. The state of at least one bit in a word is variable and may change depending on the state of the device or the commands executed by the device.

X = F or V. The content of the word may be fixed or variable.

7.2 Models

The following table lists the available 2.5-inch models of the Intel SSD E 5400s Series.

Table 20: Available Models

Model String	Capacity
SSDSC2KR080H6	80GB
SSDSC2KR120H6	120GB
SSDSC2KR180H6	180GB