

User's Guide

60GHz mmWave Sensor EVMs



ABSTRACT

The MMWAVEICBOOST Board is combined with the compatible antenna modules from the starter kit for Industrial Radar Devices of the xWR68xx family.

Table of Contents

1 Getting Started	5
1.1 Introduction.....	5
1.2 Key Features.....	5
1.3 What's Included.....	7
2 MMWAVEICBOOST	8
2.1 Hardware.....	8
2.2 Block Diagram and Features.....	9
2.3 Muxing Scheme for Multiple Sources.....	10
2.4 Using the MMWAVEICBOOST With the Starter Kit.....	13
2.5 Interfacing with the DCA1000EVM.....	16
2.6 Power Connections.....	17
2.7 Connectors.....	17
2.8 Jumpers, Switches and LEDs.....	24
3 xWR6843ISK / IWR6843ISK-ODS REV C	29
3.1 Hardware.....	29
3.2 xWR6843ISK/IWR6843ISK-ODS Block Diagram.....	32
3.3 PCB Storage and Handling Recommendations.....	32
3.4 Power Connections.....	32
3.5 Interfaces.....	33
3.6 xWR6843ISK Antenna.....	37
3.7 IWR6843ISK-ODS Antenna.....	40
3.8 Modular Mode.....	42
3.9 DCA1000EVM Mode.....	44
3.10 MMWAVEICBOOST Mode.....	44
4 xWR6843AOPEVM Rev G	46
4.1 Hardware.....	46
4.2 Block Diagram.....	47
4.3 PCB Storage and Handling Recommendations.....	48
4.4 Heat Sink and Temperature.....	48
4.5 xWR6843AOPEVM Antenna.....	51
4.6 Switch Settings.....	53
4.7 xWR6843AOPEVM Muxing Scheme.....	54
4.8 Modular, DCA1000EVM and MMWAVEICBOOST Mode.....	54
4.9 Known Issues: Spurious Performance.....	58
4.10 PC Connection.....	59
4.11 REACH Compliance.....	60
4.12 Regulatory Statements with Respect to the xWR6843AOPEVM Rev G.....	60
5 xWR6843AOPEVM Rev F	61
5.1 Hardware.....	61
5.2 Block Diagram.....	62
5.3 PCB Storage and Handling Recommendations.....	63
5.4 Heat Sink and Temperature.....	63
5.5 xWR6843AOPEVM Antenna.....	67
5.6 Switch Settings.....	69
5.7 xWR6843AOPEVM Muxing Scheme.....	70

5.8 Modular and MMWAVEICBOOST Mode.....	70
5.9 PC Connection.....	73
5.10 REACH Compliance.....	74
6 IWR6843ISK / IWR6843ISK-ODS (deprecated).....	75
6.1 Hardware.....	75
6.2 IWR6843ISK/IWR6843ISK-ODS Block Diagram.....	78
6.3 PCB Storage and Handling Recommendations.....	78
6.4 Power Connections.....	78
6.5 Miscellaneous and LEDs.....	79
6.6 IWR6843ISK Antenna.....	79
6.7 IWR6843ISK-ODS Antenna.....	82
7 IWR6843AOPEVM (Deprecated).....	84
7.1 Hardware.....	84
7.2 Block Diagram.....	85
7.3 PCB Storage and Handling Recommendations.....	86
7.4 IWR6843AOPEVM Antenna.....	86
7.5 Switch Settings.....	89
7.6 IWR6843AOPEVM Muxing Scheme.....	90
7.7 Modular and MMWAVEICBOOST Mode.....	90
7.8 PC Connection.....	93
7.9 REACH Compliance.....	94
8 TI E2E Community.....	95
9 Certification Related Information.....	96
Revision History.....	96

List of Figures

Figure 2-1. MMWAVEICBOOST Front View.....	8
Figure 2-2. MMWAVEICBOOST Rear View.....	8
Figure 2-3. Block Diagram of MMWAVEICBOOST.....	9
Figure 2-4. Muxing Scheme.....	10
Figure 2-5. Front.....	12
Figure 2-6. Rear.....	12
Figure 2-7. Front.....	12
Figure 2-8. Uninstalled Devices.....	13
Figure 2-9. COM Ports After the Driver Installation.....	14
Figure 2-10. Integration of MMWAVEICBOOST and Starter Kit.....	15
Figure 2-11. Mechanical Mounting of the PCB.....	15
Figure 2-12. IWR6843ISK-MMWAVEICBOOST-DCA1000EVM Test Setup.....	16
Figure 2-13. Power Connector.....	17
Figure 2-14. P3 Header.....	17
Figure 2-15. P7 Header.....	17
Figure 2-16. J27 Header.....	17
Figure 2-17. TI Standard LaunchPad.....	18
Figure 2-18. 60-Pin HD Connectors.....	19
Figure 2-19. 60-Pin HD Connector (DCA1000).....	22
Figure 2-20. 60-Pin MIPI Connector.....	22
Figure 2-21. 14-Pin JTAG Connector.....	23
Figure 2-22. CAN Connectors.....	24
Figure 2-23. UMC Connector.....	24
Figure 2-24. SOP Jumpers.....	25
Figure 2-25. J13 Header.....	26
Figure 2-26. SW1.....	27
Figure 2-27. SW2.....	27
Figure 2-28. S1 Switch.....	27
Figure 2-29. DS1.....	28
Figure 2-30. DS2.....	28
Figure 2-31. LEDs.....	28
Figure 2-32. D4 & D9.....	28
Figure 2-33. D11 & D14.....	28
Figure 3-1. xWR6843ISK Front View.....	29
Figure 3-2. xWR6843ISK Rear View.....	30
Figure 3-3. PCB Antenna – Top.....	31
Figure 3-4. PCB Antenna – Bottom.....	31

Figure 3-5. Block Diagram of xWR6843ISK/IWR6843ISK-ODS.....	32
Figure 3-6. LED location and color.....	35
Figure 3-7. CAN Connector location and label.....	36
Figure 3-8. PCB Antennas.....	37
Figure 3-9. IWR6843ISK antenna placement MIMO array.....	38
Figure 3-10. TX1 Antenna Radiation Pattern in Azimuth.....	39
Figure 3-11. TX2 Antenna Radiation Pattern in Azimuth.....	39
Figure 3-12. TX3 Antenna Radiation Pattern in Azimuth.....	39
Figure 3-13. TX1 Antenna Radiation Pattern in Elevation.....	39
Figure 3-14. TX2 Antenna Radiation Pattern in Elevation.....	39
Figure 3-15. TX3 Antenna Radiation Pattern in Elevation.....	39
Figure 3-16. IWR6843ISK-ODS PCB Antenna.....	40
Figure 3-17. IWR6843ISK-ODS antenna placement MIMO array.....	40
Figure 3-18. Measured Azimuthal Radiation Pattern for All Tx to Rx Pairs (All 12 Virtual Antenna Pairs Included).....	41
Figure 3-19. Measured Elevation Radiation Pattern for All Tx to Rx Pairs (All 12 Virtual Antenna Pairs Included).....	42
Figure 3-20. Virtual COM port.....	42
Figure 3-21. Modular Mode Setup.....	43
Figure 3-22. DCA1000EVM mode.....	44
Figure 3-23. mmWAVEICBOOST mode.....	45
Figure 4-1. xWR6843AOPEVM Top View.....	46
Figure 4-2. xWR6843AOPEVM Bottom View.....	47
Figure 4-3. Block Diagram of the xWR6843AOPEVM.....	47
Figure 4-4. Duty Cycle versus Junction Temperature.....	48
Figure 4-5. Heat sink CAD drawing.....	49
Figure 4-6. Heat sink placement.....	50
Figure 4-7. AOP Antennas.....	51
Figure 4-8. IWR6843AOP antenna placement MIMO array.....	51
Figure 4-9. Measured Azimuth Radiation Pattern for All Tx to Rx Pairs (All 12 Virtual Antenna Pairs Included).....	52
Figure 4-10. Measured Elevation Radiation Pattern for All Tx to Rx Pairs (All 12 Virtual Antenna Pairs Included).....	52
Figure 4-11. xWR6843AOPEVM Switches.....	53
Figure 4-12. Switch Configuration for Modular (USB) Mode.....	55
Figure 4-13. Switch Configuration for Modular (Bluetooth) Mode.....	55
Figure 4-14. Switch Configuration for DCA1000EVM Mode.....	56
Figure 4-15. Setup with xWR6843AOPEVM and DCA1000EVM.....	56
Figure 4-16. xWR6843AOPEVM Mounted on MMWAVEICBOOST.....	57
Figure 4-17. Switch Configuration for MMWAVEICBOOST Mode.....	58
Figure 4-18. ADC spectrum with spread spectrum enabled (blue) vs disabled (red).....	59
Figure 4-19. CP2105 COM Ports.....	59
Figure 5-1. xWR6843AOPEVM Top View.....	61
Figure 5-2. xWR6843AOPEVM Bottom View.....	62
Figure 5-3. Block Diagram of the xWR6843AOPEVM.....	63
Figure 5-4. Duty Cycle versus Junction Temperature.....	64
Figure 5-5. Heat sink CAD drawing.....	65
Figure 5-6. Heat sink placement.....	66
Figure 5-7. AOP Antennas.....	67
Figure 5-8. IWR6843AOP antenna placement MIMO array.....	67
Figure 5-9. Measured Azimuthal Radiation Pattern for All Tx to Rx Pairs (All 12 Virtual Antenna Pairs Included).....	68
Figure 5-10. Measured Elevation Radiation Pattern for All Tx to Rx Pairs (All 12 Virtual Antenna Pairs Included).....	68
Figure 5-11. xWR6843AOPEVM Switches.....	69
Figure 5-12. Switch Configuration for Modular Mode.....	71
Figure 5-13. Switch Configuration for Bluetooth Mode.....	72
Figure 5-14. xWR6843AOPEVM Mounted on MMWAVEICBOOST.....	72
Figure 5-15. Switch Configuration for MMWAVEICBOOST Mode.....	73
Figure 5-16. SICP2015 COM Ports.....	73
Figure 6-1. IWR6843ISK Front View.....	75
Figure 6-2. IWR6843ISK Rear View.....	76
Figure 6-3. PCB Antenna – Top.....	77
Figure 6-4. PCB Antenna – Bottom.....	77
Figure 6-5. Block Diagram of IWR6843ISK/IWR6843ISK-ODS.....	78
Figure 6-6. PGood LED.....	79
Figure 6-7. PCB Antennas.....	80
Figure 6-8. TX1 Antenna Radiation Pattern in Azimuth.....	80
Figure 6-9. TX2 Antenna Radiation Pattern in Azimuth.....	80

Figure 6-10. TX3 Antenna Radiation Pattern in Azimuth.....	81
Figure 6-11. TX1 Antenna Radiation Pattern in Elevation.....	81
Figure 6-12. TX2 Antenna Radiation Pattern in Elevation.....	81
Figure 6-13. TX3 Antenna Radiation Pattern in Elevation.....	81
Figure 6-14. IWR6843ISK-ODS PCB Antenna.....	82
Figure 6-15. Measured Azimuthal Radiation Pattern for All Tx to Rx Pairs (All 12 Virtual Antenna Pairs Included).....	82
Figure 6-16. Measured Elevation Radiation Pattern for All Tx to Rx Pairs (All 12 Virtual Antenna Pairs Included).....	83
Figure 7-1. IWR6843AOPEVM Top View.....	84
Figure 7-2. IWR6843AOPEVM Bottom View.....	85
Figure 7-3. Block Diagram of the IWR6843AOPEVM.....	86
Figure 7-4. AOP Antennas.....	87
Figure 7-5. Measured Azimuthal Radiation Pattern for All Tx to Rx Pairs (All 12 Virtual Antenna Pairs Included).....	88
Figure 7-6. Measured Elevation Radiation Pattern for All Tx to Rx Pairs (All 12 Virtual Antenna Pairs Included).....	88
Figure 7-7. IWR6843AOPEVM Switches.....	89
Figure 7-8. Switch Configuration for Modular Mode.....	91
Figure 7-9. Switch Configuration for BT Mode.....	91
Figure 7-10. Switch Configuration for MMWAVEICBOOST Mode.....	93
Figure 7-11. SICP2015 COM Ports.....	93

List of Tables

Table 2-1. Switch Settings.....	11
Table 2-2. Mux Selection Images.....	12
Table 2-3. Board Power.....	17
Table 2-4. J6 Connector Pinout.....	18
Table 2-5. J5 Connector Pinout.....	19
Table 2-6. J4 Connector Pinout.....	20
Table 2-7. J17 Connector Pinout.....	21
Table 2-8. CAN Connectivity.....	23
Table 2-9. SOP Jumper Information.....	24
Table 2-10. I2C Jumper Settings.....	25
Table 2-11. I2C Devices and Addresses.....	25
Table 2-12. 3.3-V Rail Options.....	26
Table 2-13. Miscellaneous Headers.....	26
Table 2-14. Switches Information.....	27
Table 2-15. LEDs Information.....	28
Table 3-1. List of LEDs.....	35
Table 3-2. IWR6843ISK I2C Devices and Address.....	36
Table 3-3. S1 Config Flashing and Functional Mode.....	43
Table 3-4. S1 Config for DCA1000EVM mode.....	44
Table 3-5. S1 Config for mmWAVEICBOOST mode.....	45
Table 4-1. Switches.....	53
Table 4-2. Pin Mux Settings.....	54
Table 4-3. SOP Configuration.....	54
Table 4-4. REACH Information.....	60
Table 5-1. Switches.....	69
Table 5-2. Pin Mux Settings.....	70
Table 5-3. SOP Configuration.....	70
Table 5-4. REACH Information.....	74
Table 6-1. List of LEDs.....	79
Table 6-2. IWR6843ISK I2C Devices and Address.....	79
Table 7-1. Switches.....	89
Table 7-2. Pin Mux Settings I.....	90
Table 7-3. Pin Mux Settings II.....	90
Table 9-1. Declared Maximum Mean Power.....	96

Trademarks

LaunchPad™ and BoosterPack™ are trademarks of Texas Instruments.
All trademarks are the property of their respective owners.

1 Getting Started

1.1 Introduction

xWR6843ISK/IWR6843ISK-ODS/ IWR6843AOPEVM and MMWAVEICBOOST are part of mmWave EVMs hardware. The xWR6843 antenna board from Texas Instruments is an easy-to-use evaluation module for the xWR6843 mmWave sensing device. This board contains 60-GHz mmWave Radar transceiver in which antennas are etched on PCB or on packager and act as the Radar front-end board. The MMWAVEICBOOST is an add-on board used with TI's mmWave sensor used in all starter kits to provide more interfaces and PC connectivity to the mmWave sensors. The MMWAVEICBOOST board provides an interface for the mmWave Studio tool to configure the Radar device and capture the raw analog-to-digital converter (ADC) data, using a capture board such as DCA1000 evaluation module (EVM). xWR6843 antenna EVMs and MMWAVEICBOOST contains everything required to start developing software for on-chip C67x DSP core and low-power ARM R4F controllers. It provides an interface to the MSP43xx boards through 40-pin LaunchPad™/ BoosterPack™ connectors.

Revision currently available on product page	Silicon Version
MMWAVEICBOOST Rev. B	-
AWR6843ISK Rev. C	ES2
IWR6843ISK Rev. B	ES2
IWR6843ISK-ODS Rev. B	ES2
IWR6843AOPEVM Rev. F	ES2

Note

All older revisions not listed are deprecated and may contain deprecated silicon version

1.2 Key Features

	Integrated Antenna 60-GHz Intelligent Edge Sensor IWR6843AoPEVM	High Performance 60-GHz Intelligent Edge Sensor xWR6843ISK	60-GHz Intelligent Edge Sensor IWR6843ISK-ODS
Tuning Frequency	60-64 GHz	60-64 GHz	60-64 GHz
Number of Receivers	4	4	4
Number of Transmitter	3	3	3
Processing	<ul style="list-style-type: none"> MCU FFT accelerator DSP 	<ul style="list-style-type: none"> MCU FFT accelerator DSP 	<ul style="list-style-type: none"> MCU FFT accelerator DSP
Memory	1.75 MB	1.75 MB	1.75 MB
Antenna	Antenna on Package	Antenna on PCB	Antenna on PCB
Azimuth FOV (deg) ²	+/- 60	+/- 60	+/- 60
Azimuth Angular Resolution (deg) ¹	29	15	29
Elevation FOV (deg) ²	+/- 60	+/- 15	+/- 60
Elevation Angular Resolution (deg) ¹	29	58	29
Gain	5dBi	7dBi	5dBi
Modular Mode	<ul style="list-style-type: none"> Requires mmWaveICBOOST for debugging and DCA1000 Flashing and functional mode available without mmWaveICBOOST 	<ul style="list-style-type: none"> Requires mmWaveICBOOST for debugging Flashing and functional mode available without mmWaveICBOOST 	<ul style="list-style-type: none"> Requires mmWaveICBOOST for debugging Flashing and functional mode available without mmWaveICBOOST
Raw ADC Data Capture	Yes – requires mmWaveICBOOST + DCA1000	Yes – requires DCA1000	Yes – requires DCA1000

- Angular resolution is defined as how far apart two objects must be (in angle) for them to be detected as separate objects. It is different from angular accuracy, which is how accurately the angle of an object is detected.
- 6-dB beam width of resultant pattern due to TX and RX combination

1.2.1 Summary of Features

Feature	Comment	xWR6843ISK	IWR6843ISK-ODS	IWR6843AOPEVM
Modular Mode	For code flashing, Running Demos mmWaveicboost carrier not needed	√	√	√
USB Powered	Data + Power over USB host. No external 5V Supply needed.	√	√	√
Direct DCA1000 mating	For Raw Data capture direct connection to DCA1000 via 60Pin Samtec Header.	√	√	-
JTAG Debug	Code debug using XDS110 JTAG emulator	Requires MMWAVEICBOOST	Requires MMWAVEICBOOST	Requires MMWAVEICBOOST
CAN FD Phy. Instances on	Direct connectivity to CANFD peripheral available on Antenna Board	2	2	2

1.2.2 xWR6843ISK

- 60-pin, high-density (HD) connector for raw analog-to-digital converter (ADC) data over LVDS and trace data capability
- Long range on-board antenna**
- Current sensors for all rails
- On-board PMIC

1.2.3 IWR6843ISK-ODS (Overhead Detection Sensing)

- 60-pin, high-density (HD) connector for raw analog-to-digital converter (ADC) data over LVDS and trace data capability
- Short range on-board antenna**
- Current sensors for all rails
- On-board PMIC

1.2.4 IWR6843AOP

- 60-pin, high-density (HD) connector for raw analog-to-digital converter (ADC) data over LVDS and trace data capability
- Short range on-package antenna**
- On-board PMIC

1.2.5 MMWAVEICBOOST

- Hosts starter kit using two 60-pin high-density (HD) connector for the high-speed ADC data over CSI or LVDS and emulator signals
- FTDI-based JTAG emulation with serial port for programming flash on the starter kit
- XDS110-UART based QSPI flash programming
- 60-pin HD connector to interface with the DCA1000 EVM
- Two 20-pin LaunchPad connectors that leverage the ecosystem of the TI standard Launchpad and have all of the digital controls from the Radar chip
- Two onboard controller area network (CAN) transceivers
- On-board PMIC
- 60-pin MIPI HD connector for JTAG trace
- On-board FTDI chip to provide PC interface for serial peripheral interface (SPI), general-purpose input/output (GPIO) controls and universal asynchronous receiver/transmitter (UART) loggers
- On-board current sensors and temperature sensors

1.3 What's Included

1.3.1 Kit Contents

The following items are included with the EVM kit.

1.3.1.1 xWR6843ISK

- xWR6843ISK evaluation board
- Warranty card (disclaimer sheet)
- Quick Start Guide

1.3.1.2 IWR6843ISK-ODS

- IWR6843ISK-ODS evaluation board
- Warranty card (disclaimer sheet)
- Quick Start Guide

1.3.1.3 IWR6843AOPEVM

- IWR6843AOPEVM evaluation board
- Warranty card (disclaimer sheet)
- Quick Start Guide

1.3.1.4 MMWAVEICBOOST

- MMWAVEICBOOST evaluation board
- One Micro USB cable for connecting to PC
- Standoffs, screws and nuts for the standalone printed circuit board testing or for mating purpose
- Jumpers

Note

A 5-V, > 2.5-A supply brick with a 2.1-mm barrel jack (center positive) is not included. TI recommends using an external power supply that complies with applicable regional safety standards, such as UL, CSA, VDE, CCC, PSE, and more. The length of the power cable should be < 3 m.

2 MMWAVEICBOOST

2.1 Hardware

Figure 2-1 and Figure 2-2 shows the front and rear view of EVM, respectively.

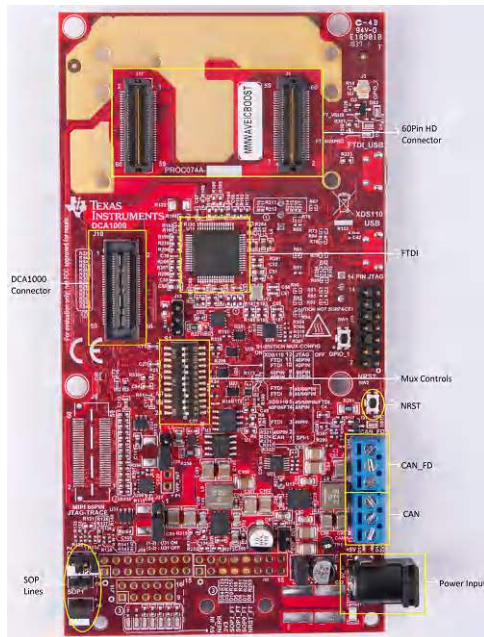

Figure 2-1. MMWAVEICBOOST Front View

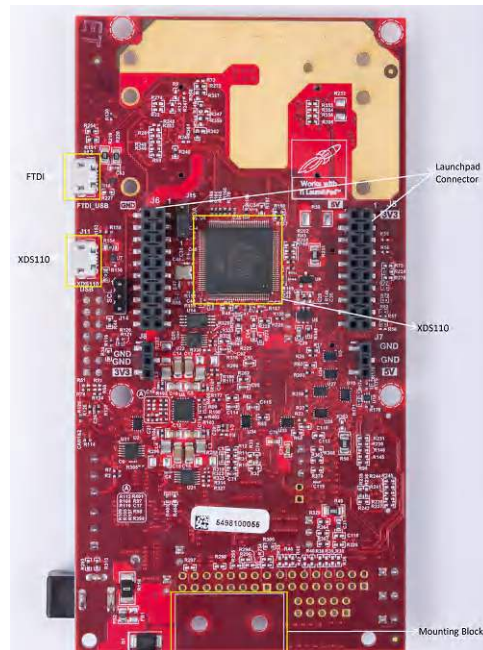

Figure 2-2. MMWAVEICBOOST Rear View

2.2 Block Diagram and Features

2.2.1 Block Diagram

Figure 2-3 shows the block diagram.

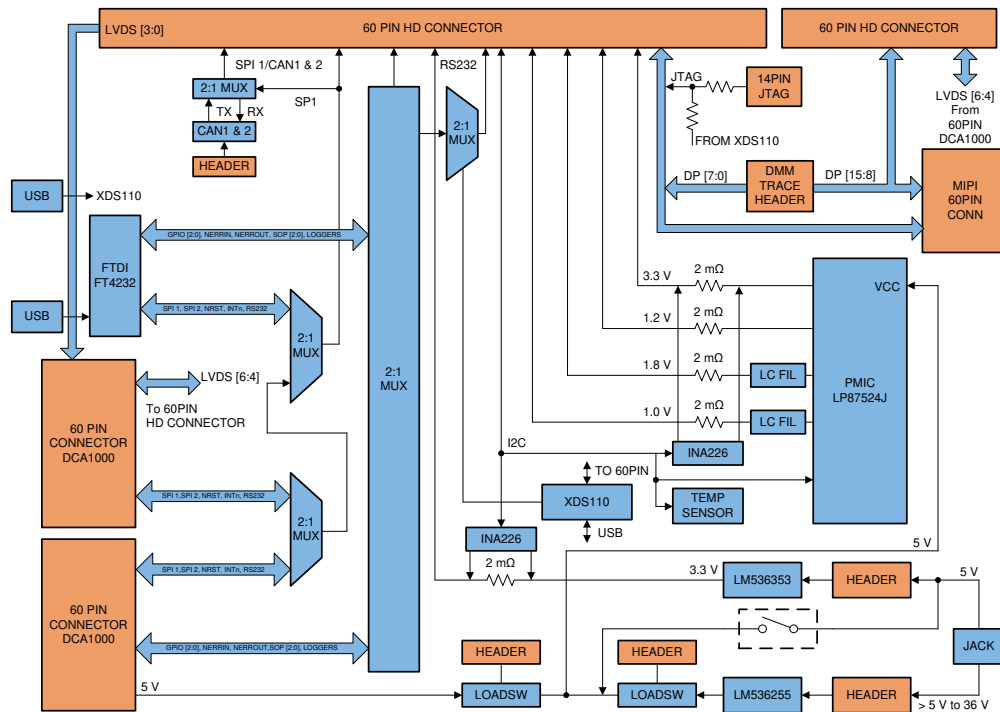

Figure 2-3. Block Diagram of MMWAVEICBOOST

2.2.2 Hardware Features

- 1 Micro USB connector for XDS110 Emulator/UART interface
- 1 Micro USB connector for FTDI interface
- One 12-pin dip switch for mux controls
- One push button and two LEDs for basic user interface
- Current sensors for all rails
- 5-V power jack to power the board
- Header for external JTAG connection

2.3 Muxing Scheme for Multiple Sources

There are multiple sources as shown in Figure 2-4 such as 40 pin LP/BP, DCA1000 EVM, onboard FTDI and XDS110 that can control the Radar front-end chip in the starter kit. This is done with the help of mux scheme implemented on the MMWAVEICBOOST. Follow the switch settings as shown in Table 2-1 to avoid the conflicts. The most used configuration is the default position.

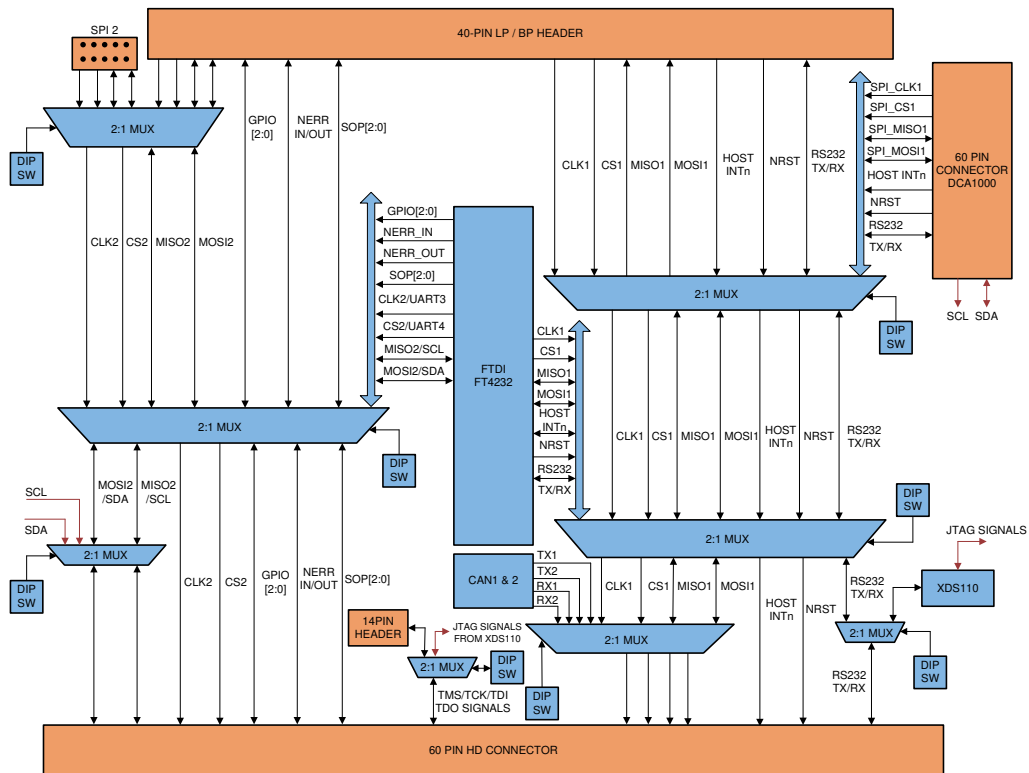
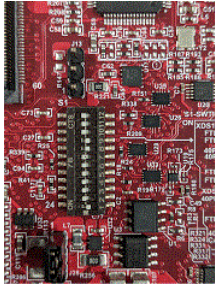
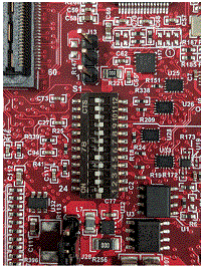
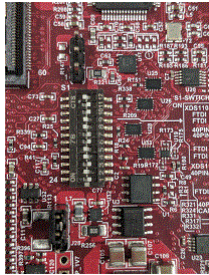

Figure 2-4. Muxing Scheme

Table 2-1 shows the dip switch settings for multiple sources connecting to mmWave sensing device.

Table 2-1. Switch Settings

Reference Designator	(Default Position) Position for STAND ALONE Mode ⁽¹⁾	Position for DCA1000 Mode	Position for 40-Pin LP/BP
			
S1.12	ON	ON	ON
S1.11	ON	ON	OFF
S1.10	ON	ON	OFF
S1.9	OFF	OFF	ON
S1.8	OFF	OFF	ON
S1.7	ON	OFF	OFF
S1.6	ON	OFF	OFF
S1.5 ⁽²⁾	ON	ON	OFF
S1.4	ON	OFF	ON
S1.3	ON	ON	OFF
S1.2	ON	ON	ON
S1.1	OFF	OFF	OFF

(1) Standalone mode means starter kit and MMWAVEICBOOST connected together.

(2) S1.5 has RS232 connections from 40 pin/FTDI/60 pin/XDS110, ON position routes UART to XDS110 (Application/user UART COM port).

Table 2-2 shows the images of NRST, DIP switch settings, SOP lines, and power input locations on the physical board.

Table 2-2. Mux Selection Images

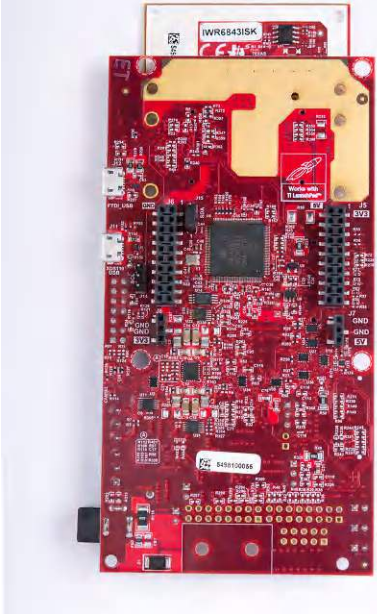
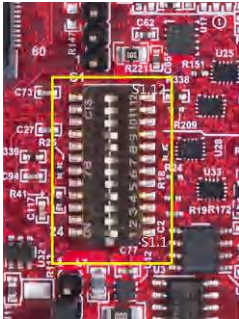
	Front	Rear
Whole Board	 <p>Figure 2-5. Front</p>	 <p>Figure 2-6. Rear</p>
Zoomed IN	 <p>Figure 2-7. Front</p>	

2.4 Using the MMWAVEICBOOST With the Starter Kit

The MMWAVEICBOOST board is required with the starter kit for the following use cases:

- PC connection is enabled for communicating with the mmWave front end chip
- Connecting to mmWave Studio (mmWave Studio is a tool that provides capability to configure the MMWAVEICBOOST front end from the PC). This tool is available [online](#).
- The DCA1000 EVM allows users to capture the raw ADC data over the high-speed debug interface and post process it in the PC.
- Getting DSP trace data through the MIPI 60-pin interface
- DMM interface can be used

2.4.1 PC Connection

Connectivity is provided through the micro USB connector over the onboard FTDI and XDS110 ICs. This provides the following interfaces to the PC:

- XDS110 provides the default UART interface for application/user port and auxiliary data port
- FTDI Port A -> SPI interface for radar device control using mmWave Studio
- FTDI Port B-> I2C interface and host INTR signal
- FTDI Port C -> BSS Logger port (for internal debug only), NRST control, and Nerror signals
- FTDI Port D -> DSS Logger port, SOP line control signals, and GPIO signals

When the USB is connected for the first time to the PC, Windows® maybe not be able to recognize the device. This is indicated in the device manager with yellow exclamation marks as shown in [Figure 2-8](#).

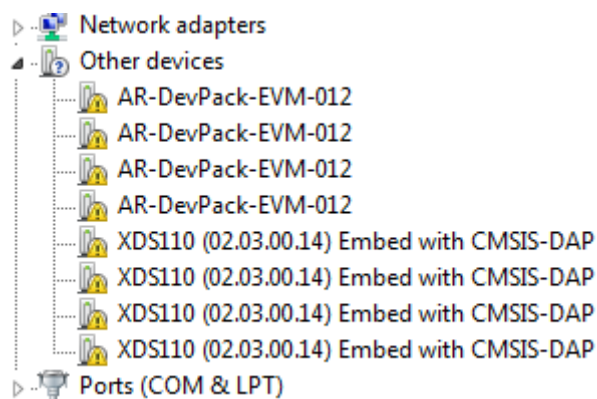

Figure 2-8. Uninstalled Devices

To install the devices:

1. Download the latest FTDI and XDS110 drivers available in the mmWave SDK package.
2. Right click on these devices.
3. Update the drivers by pointing to the location where the FTDI and XDS110 drivers are downloaded.

This must be done for all eight COM ports. When eight COM ports are installed, the device manager recognizes these devices and indicates the COM port numbers, as shown in [Figure 2-9](#).



Figure 2-9. COM Ports After the Driver Installation

2.4.2 Flashing the QSPI Flash on the Antenna Module

For the flashing, only one USB cable (XDS110 USB) must be connected to the PC; the Uniflash utility must be used load the binary onto the antenna module. Connecting both XDS110_USB and FTDI_USB can prevent the uniflash utility from running successfully.

2.4.3 MMWAVEICBOOST and Antenna Module Connections for Modular Testing

A compatible antenna module can be stacked on top of the MMWAVEICBOOST board using the two 60-pin HD connectors and 12 nuts, four washers, and four M3 screws (for improving the thermal performance). Connectors have a pin number marking shown in [Figure 2-18](#) to prevent the misalignment of the pins or reverse connection. [Figure 2-10](#) shows the integration of MMWAVEICBOOST and starter kit. The starter kit is powered by the 3.3-V supply. There is one micro USB cable to XDS110 (J11) to run the out-of-box demo, and one micro USB cable to FTDI (J12) for initiating controls from mmWave Studio. Digital controls from the MMWAVEICBOOST are initiated after the FTDI and XDS110 ports are detected in the device manager shown in [Figure 2-9](#). The configuration of the MMWAVEICBOOST and starter kit are based on the analog mux settings and mux controls received from the dip switch (S1). To mux all the digital controls to the FTDI/XDS110 connector, set the mux control switch positions to ON/OFF, as shown in [Table 2-1](#).

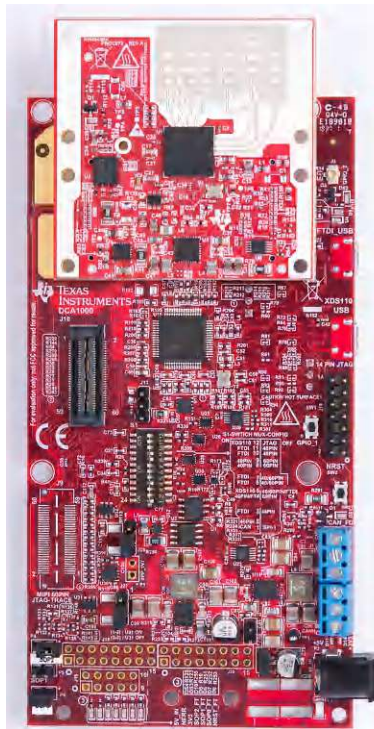

Figure 2-10. Integration of MMWAVEICBOOST and Starter Kit

Figure 2-11 shows the mechanical mounting of PCB. Spacers and screws can be used as heat sinking elements to spread the heat from the starter kit to carrier board, as shown in Figure 2-11.

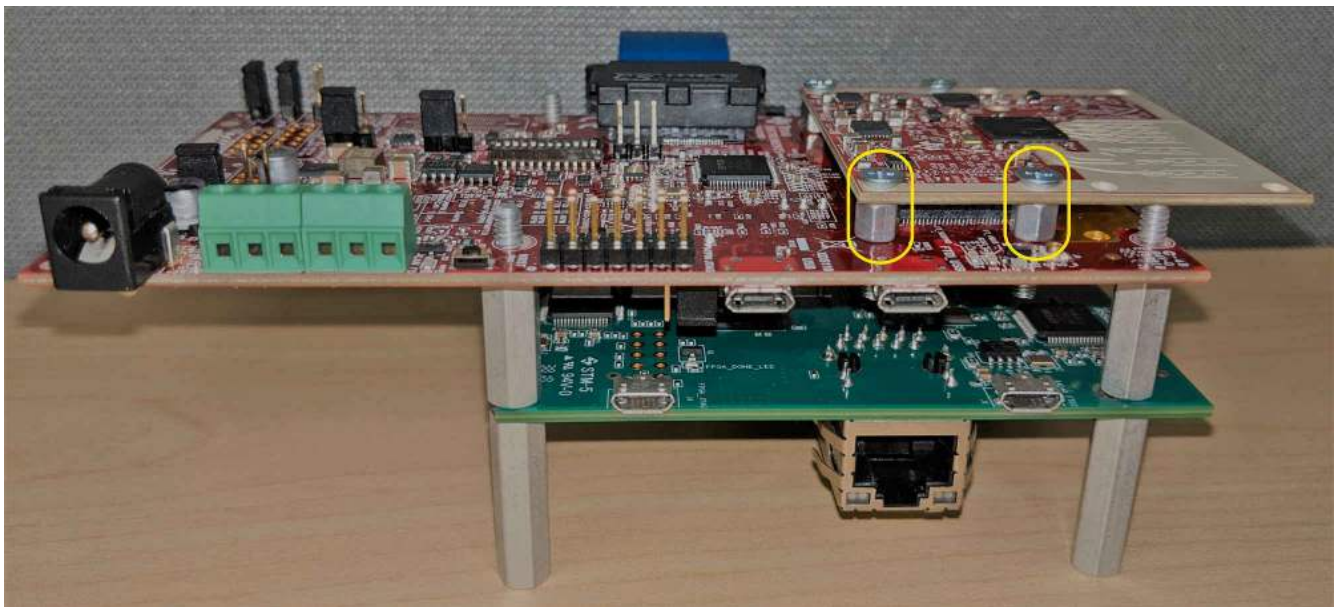

Figure 2-11. Mechanical Mounting of the PCB

2.5 Interfacing with the DCA1000EVM

The high-speed LVDS data from the radar device can be captured using the DCA1000 EVM. For more information about the DCA1000 EVM and ordering details, see the [Real Time Data Capture Adapter](#) and the [DCA1000EVM Data Capture Card User's Guide](#). mmWave Studio is required for configuration. For the installation of the tool, see the [mmWave Studio User's Guide](#).

2.5.1 mmWave Studio Interface

To control the radar device from mmWave Studio, both the starter kit and the MMWAVEICBOOST must be powered and connected to the PC using the micro USB cable. The UART used to download the firmware is accessed from the XDS110 device on the MMWAVEICBOOST. The SPI interface used to control the radar device, SOP controls, and nRST control is performed from the FTDI chip on the MMWAVEICBOOST. For details on the usage of mmWave Studio, see the [Radar Studio User's Guide](#) that is part of the DFP package.

2.5.2 MMWAVEICBOOST and Antenna Module Configuration

The configuration of the MMWAVEICBOOST and starter kit are the same as mentioned in [Section 2.4](#), except the analog mux settings and the mux controls are received from the 60-pin connector (J10) instead of FTDI. To mux all the digital controls to the 60-pin connector, the mux control switch positions should be set to ON/OFF, as shown in [Table 2-1](#),

2.5.3 DCA1000 EVM Connection

The DCA1000 EVM must be powered up with a 5-V supply and the micro-USB Ethernet cable connected to the same PC as the MMWAVEICBOOST and antenna module. A 60-pin Samtec cable (HQCD-030-02.00-SEU-TBR-1) is used to connect the 60-pin connector (J10) on the MMWAVEICBOOST to the J3 input connector on the DCA1000 EVM. Mount the four stand offs, four washers, and pan head screws to mate with the DCA1000EVM. For more information, see the setup shown in [Figure 2-12](#).

Note

The Samtec cable included in the kit is the HQCD-030-02.00-SEU-TBR-1. "02.00" indicates the length of the cable in inches; cables with longer length can be ordered by the user if needed.

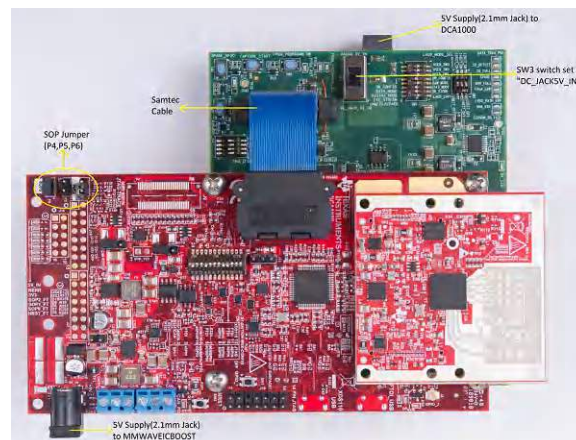

Figure 2-12. IWR6843ISK-MMWAVEICBOOST-DCA1000EVM Test Setup

2.6 Power Connections

The board is powered by 5-V power jack (2-A current limit) shown in [Figure 2-13](#).

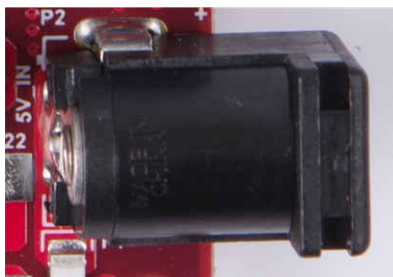





Figure 2-13. Power Connector

[Table 2-3](#) provides the jumper information for usage of board power input.

Note

TI recommends using an external power supply that complies with applicable regional safety standards, such as UL, CSA, VDE, CCC, PSE, and more. The length of the power cable should be < 3 m.

Table 2-3. Board Power

Reference Designator	Description	Image
P3	Short(Default) : Input voltage is 5 V and short R116. Open : Input voltage is more than 5 V and remove R116.	 Figure 2-14. P3 Header
P7	Short : Input voltage is more than 5 V and remove R116. Open : Input voltage is 5 V.	 Figure 2-15. P7 Header
J27	Short (1-2): Input voltage is more than 5 V. Open(2-3): Input voltage is 5V(Default)	 Figure 2-16. J27 Header

2.7 Connectors

There are several types of connectors used in the MMWAVEICBOOST board, which are mentioned below.

2.7.1 20-Pin LaunchPad and Booster Pack Connectors (J5, J6)

The MMWAVEICBOOST has the standard LaunchPad connectors (J5 and J6) that enable it to be directly connected to all TI MCU LaunchPad's pinout, as shown in Figure 2-17. While connecting the MMWAVEICBOOST to other LaunchPads, ensure the pin-1 orientation is correct by matching the 3V3 and 5-V signal marking on the boards. Figure 2-17 shows two 20-pin connectors.

Table 2-4 and Table 2-5 provide the connector pin information.

Connectivity with TI LaunchPad

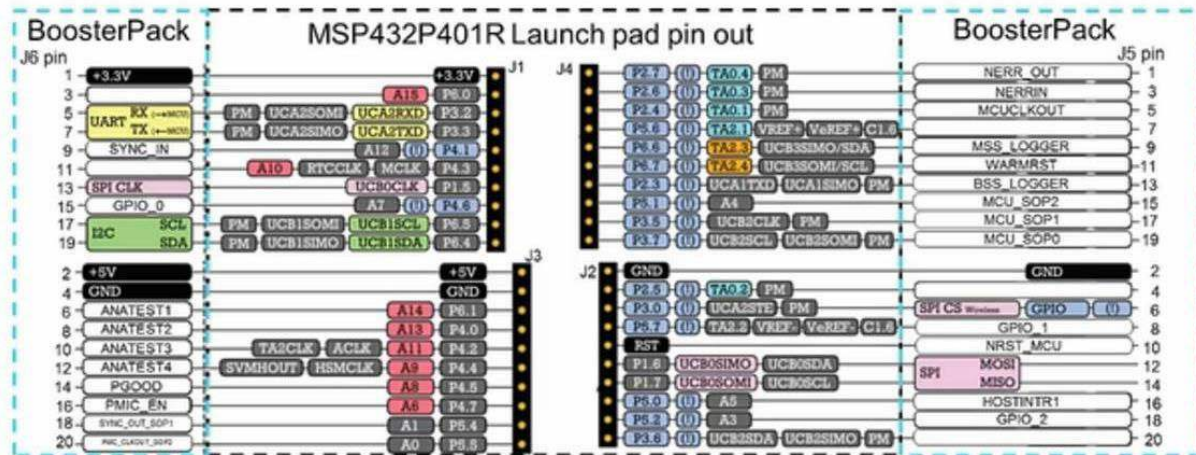

Figure 2-17. TI Standard LaunchPad

Table 2-4. J6 Connector Pinout

Pin Number	Description	Pin Number	Description
1	NERROUT	2	GND
3	NERRIN	4	DSS LOGGER
5	MCUCLKOUT	6	SPI_CS
7	NC	8	GPIO1
9	MSS_LOGGER (data from xWR device) ⁽¹⁾	10	nRESET
11	WARMRST	12	SPI_MOSI
13	BSS_LOGGER	14	SPI_MISO
15	SOP2	16	HOSTINT
17	SOP1	18	GPIO2
19	SOP0	20	NC

(1) When running the OOB demo, the MSS_Logger pin is used to send data. This is the same pin connected to the XDS110 and displayed through the emulator as a data COM port.

Table 2-5. J5 Connector Pinout

Pin Number	Description	Pin Number	Description
1	3V3	2	5V
3	NC	4	GND
5	RS232 (TX from xWR device) ⁽¹⁾	6	NC
7	RS232 (RX into xWR device) ⁽¹⁾	8	NC
9	SYNC_IN	10	NC
11	NC	12	NC
13	SPI_CLK	14	PGOOD ⁽²⁾
15	GPIO0	16	PMIC_Enable ⁽³⁾
17	SCL	18	SYNC_OUT
19	SDA	20	PMIC CLKOUT

- (1) When running the OOB demo, the RS232 TX and RX pins are used for user and configuration files. This is the same pin connected to the XDS110 and displayed through the emulator as a Application/User UART COM port.
- (2) Indicates that all the powers are stable in the standard LP/BP boards are stable, which enables or disables the power of FTDI and XDS110 interfaces. A HIGH on the PGOOD signal (3.3 V) indicates the supply is stable. The I/Os of the front-end chip are not safe to operate by the XDS110/FTDI before this I/O supply is stable, to avoid leakage current into the I/Os.
- (3) Controls the PMIC enable for starter kits. The MCU can use this to shut down the PMIC and xWR device during the periods it does not use the xWR device and save power. The power up of the PMIC takes approximately 5 ms once the enable signal is made high.

2.7.2 60-Pin High Density (HD) Connector (J4 and J17)

The 60-pin HD connector shown in [Figure 2-18](#) provides the high-speed CSI/LVDS data, controls signals (SPI, UART, I2C, NRST, NERR, and SOPs) and JTAG debug signals from the starter kit. The Trace and DMM interface lines are also available through this connector.

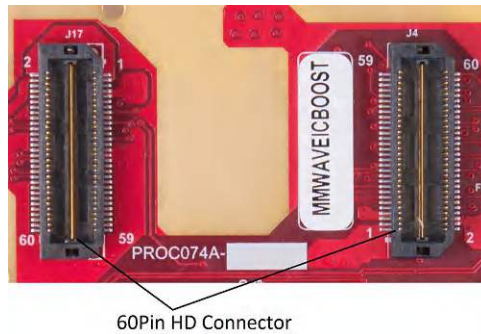

Figure 2-18. 60-Pin HD Connectors

Table 2-6 and Table 2-7 list the 60-pin HD connector pinout.

Table 2-6. J4 Connector Pinout

Pin Number	Pin Description	Pin Number	Pin Description
1	1V	31	DP2
2	5V	32	GND
3	1V	33	DP3
4	3.3V	34	LVDS_CLKP
5	1.2V	35	DP4
6	3.3V	36	LVDS_CLKM
7	1.2V	37	DP5
8	DMM_SYNC	38	GND
9	1.8V	39	DP6
10	DMM_CLK	40	LVDS_1P
11	JTAG_TDI	41	DP7
12	NRST	42	LVDS_1M
13	JTAG_TMS	43	BSS_LOGGER
14	PGOOD	44	GND
15	JTAG_TCK	45	OSC_CLKOUT
16	HOST_INTR1	46	LVDS_0P
17	JTAG_TDO/SOP0	47	MCU_CLKOUT
18	MSS_LOGGER	48	LVDS_0M
19	SPI_CS1	49	PMIC_CLKOUT/SOP2
20	GND	50	GND
21	SPI_CLK1	51	WARMRST
22	SYNC_IN	52	NERRIN
23	SPI_MOSI1	53	SDA
24	SYNC_OUT/SOP1	54	NERROUT
25	SPI_MISO1	55	SCL
26	GND	56	GPIO_0
27	DP0	57	RS232_RX
28	LVDS_FRCLKP	58	GPIO_1
29	DP1	59	RS232_TX
30	LVDS_FRCLKM	60	GPIO_2

Table 2-7. J17 Connector Pinout

Pin Number	Pin Description	Pin Number	Pin Description
1	5V	31	GND
2	5V	32	LVDS_3P
3	5V	33	GND
4	VPP_1.7V	34	LVDS_3M
5	GND	35	NC
6	NC	36	GND
7	3.3V	37	NC
8	NC	38	LVDS_2P
9	3.3V	39	NC
10	NC	40	LVDS_2M
11	PMIC_EN	41	NC
12	NC	42	GND
13	DP8	43	NC
14	NC	44	NC
15	DP9	45	NC
16	NC	46	NC
17	DP10	47	NC
18	GND	48	NC
19	DP11	49	NC
20	LVDS_VALIDP	50	NC
21	DP12	51	NC
22	LVDS_VALIDM	52	NC
23	DP13	53	NC
24	GND	54	NC
25	DP14	55	NC
26	NC	56	NC
27	DP15	57	NC
28	NC	58	NC
29	GND	59	NC
30	GND	60	NC

2.7.3 60-Pin High Density (HD) Connector (J10)

This connector enables interfacing of LVDS signals to the to the DCA1000 EVM for data capturing purposes, as shown in [Figure 2-19](#). DIP switch (S1) combinations must be set to ON/OFF, as mentioned in [Table 2-1](#), before interfacing to the DCA1000 EVM.



Figure 2-19. 60-Pin HD Connector (DCA1000)

2.7.4 MIPI 60-Pin Connector (J9)

This connector provides the standard MIPI 60-pin interface, as shown in [Figure 2-20](#) for JTAG and trace capability through emulators such as the XDS560pro. To use this interface, the JTAG lines from the onboard emulator (XDS110) and 14-pin JTAG connector must be disconnected; this is done with S1 (12th position of dip switch should be open), and the JTAG Debugger should not be connected on the 14-pin connector.



Figure 2-20. 60-Pin MIPI Connector

2.7.5 TI 14-Pin JTAG Connector (J19)

This connector provides a JTAG interface shown in [Figure 2-21](#) for debug and development through external XDS emulators. To use this interface, the JTAG lines to the onboard emulator (XDS110) must be disconnected; this is done with S1 (12th position of DIP switch should be open), and the external emulator on the MIPI 60-pin connector also must be disconnected.



Figure 2-21. 14-Pin JTAG Connector

2.7.6 CAN Connector (J1 and J2)

The J1 and J2 connectors shown in [Table 2-8](#) provide the CAN_L and CAN_H signals from the onboard CAND-FD transceiver (TCAN1042HGVDQR1) and CAN transceiver (SN65HVDA540QDR) independently, as shown in [Figure 2-22](#). These signals are wired to the CAN bus after muxing with the SPI interface signals; one of the two paths must be selected. Two CANs are selected by closing the switch S1 (1st position of switch to be ON).

Table 2-8. CAN Connectivity

Pin Description	Device Interface	Connector on Board
SPI_CS1 SPI_CLK1	CAN2_TX CAN2_RX	J2 pin 1 (CAN2 corresponds to Regular CAN) J2 pin 3
MISO_1 MOSI_1	CAN1_TX CAN1_RX	J1 pin 1 (CAN1 corresponds to CANFD) J1 pin 3

[Figure 2-22](#) shows the CAN connectors.

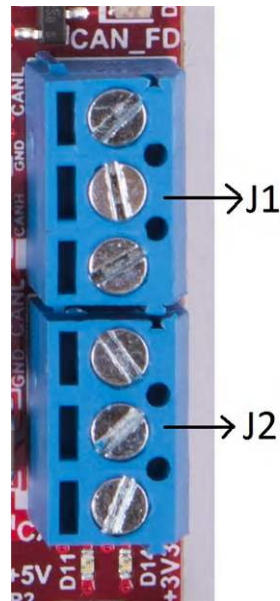

Figure 2-22. CAN Connectors

2.7.7 Ultra-Miniature Coaxial Connector (J3)

This connector provides the interface to monitor the reference clock (OSC_CLKOUT) from the starter kit through the 60-pin HD connector for debug purposes. The signal can be taken out with a coaxial cable and monitored.

Figure 2-23 shows the UMC jack.

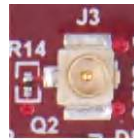

Figure 2-23. UMC Connector

2.8 Jumpers, Switches and LEDs

2.8.1 Sense on Power (SOP) Jumpers

The mmWave sensor device can be set to operate in three different modes based on the state of the SOP lines. These lines are sensed only during boot up of the mmWave sensor device. The state of the device is detailed by Table 2-9.

A closed jumper refers to a 1, and an open jumper refers to a 0 state of the SOP signal going to the mmWave sensor device.

Table 2-9. SOP Jumper Information

Reference Designator		Usage	Description
P6	SOP0	SOP[2:0]	011 (SOP mode 2) = development mode
P5	SOP1		001 (SOP mode 4) = functional mode
P4	SOP2		101 (SOP mode 5) = flash programming

Figure 2-24 shows the SOP jumpers.



Figure 2-24. SOP Jumpers

2.8.2 I2C Connections

The board features temperature sensor for measuring onboard temperature. These are connected to the I2C bus and can be isolated using the zero Ω provided on the hardware.

Table 2-10 provides the jumper settings for I2C.

Table 2-10. I2C Jumper Settings

Reference Designator	Usage	Comments
J14	I2C SCL	1-2(default) :FTDI/60 pin(J10) 2-3 : XDS110
J15	I2C SDA	1-2(default) : FTDI/60 pin(J10) Pin 2-3 : XDS110

2.8.2.1 Default I2C Address

Table 2-11 provides the list of I2C devices and its address.

Table 2-11. I2C Devices and Addresses

Sensor Type	Reference Designator	Part Number	Slave Address
Temp sensor 1	U18	TMP112AIDRLR	100 1001
Temp sensor 2	U19	TMP112AIDRLR	100 1000
Current sensor for 3.3V rail	U11	INA226AIDGST	100 0010
Current sensor for 1.8V rail	U21	INA226AIDGST	100 0110
Current sensor for 1.2V rail	U22	INA226AIDGST	100 0111
Current sensor for 1.0V rail	U23	INA226AIDGST	100 1100
Current sensor for 3.3V (PMIC)	U20	INA226AIDGST	100 0011
PMIC	U4	LP87524JRNFRQ1	110 0000

2.8.2.2

PMIC(U4) rails such as 1.8 V, 1.2 V, 1.0 V, and 3.3 V are disabled by default. 3.3 V is derived from input 5-V jack, on-board micro USB connector, or from the 40-pin LaunchPad, as shown in Table 2-12. 3.3 V is for the starter kits and the rest of the board to operate.

2.8.2.3 3.3-V Rail Options

Table 2-12. 3.3-V Rail Options

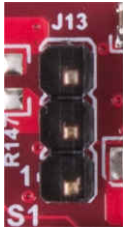
Reference Designator	Description	Image
J13	Short (1-2) : 3.3 V from FTDI LDO Short(2-3) : 3.3 V from 40-pin LP/BP connector Open (1-2-3) : Default	 <p>Figure 2-25. J13 Header</p>

Note

Remove the P3 jumper when using a 3.3-V rail from the 40-pin LP/BP or FTDI LDO, and mount the R122 resistor if it is from the 40-pin LP/BP. The current rating is limited to 1A, either from the FTDI or 40-pin LP/BP.

2.8.2.4 Miscellaneous Headers

Table 2-13 provides the list of miscellaneous headers and usage.

Table 2-13. Miscellaneous Headers

Reference Designator	Usage	Comments
P1	VPP 1.7-V generation for fuse chain	1-2(default) : Closed
J27	Enables/disables the load switch (U31) of 5-V supply generation either from > 5-V or 5-V circuitry. (1-2) indicates >5 V (2-3) indicates 5 V	1-2 : Open 2-3 (default) :Closed
J28	Enables/disables the load switch (U32) of 5-V supply generation either from 5-V circuitry or 40-pin LP/BP connector. (1-2) indicates 20-pin LP/BP (2-3) indicates 5 V	1-2 : Open 2-3 (default) :Closed
J16	LP/BP spare header	Onboard 10-pin header provides external user control for configuring the LP/BP pins partially.
J18	DMM trace header 1	Onboard 16-pin header provides external user control for JTAG trace signals.
J20	DMM trace header 2	Onboard 16-pin header provides external user control for JTAG trace signals.

2.8.2.5 Switches and LEDs

2.8.2.5.1 Switches

Table 2-14 shows the list of push buttons and usage.

Table 2-14. Switches Information







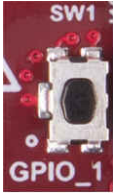

Reference Designator	Usage	Comments	Image
SW1	GPIO_1	When pushed, the GPIO_1 is pulled to Vcc.	 <p>Figure 2-26. SW1</p>
SW2	RESET	This is used to RESET the mmWave Sensor device. This signal is also output on the 20-pin, 60-pin connectors and FTDI interfaces so an external processor can control the mmWave Sensor device. The onboard XDS110 can also control this reset.	 <p>Figure 2-27. SW2</p>
S1.1	CAN/SPI selection	OFF : SPI-1(default) ON : CAN	 <p>Figure 2-28. S1 Switch</p>
S1.2	Header(J16) and 40 pin	OFF : J16 Header ON : 40 pin (default)	
S1.3	Header(J16)/40 pin and FTDI	OFF : 40 pin/J16 header ON : FTDI (default)	
S1.4	60 pin and FTDI/40 pin/J16	OFF : 60 pin ON : FTDI/J16 header/40 pin (default)	
S1.5	60 pin/FTDI/40 pin and XDS110	OFF : 40/60 pin/FTDI ON : XDS110 (default)	
S1.6	60/40 pin and FTDI	OFF : 60/40 pin ON : FTDI (default)	
S1.7	60/40 pin and FTDI	OFF : 60/40 pin ON : FTDI (default)	
S1.8	40 pin and 60 pin	OFF : 60 pin (default) ON : 40 pin	
S1.9	40 pin and 60 pin	OFF : 60 pin (default) ON : 40 pin	
S1.10	40 pin and FTDI	OFF : 40 pin ON : FTDI (default)	
S1.11	40 pin and FTDI	OFF : 40 pin ON : FTDI (default)	
S1.12	XDS110/14 pin	OFF : 14 pin ON : XDS110 (default)	

Table 2-15 provides the list of LEDs and usage.

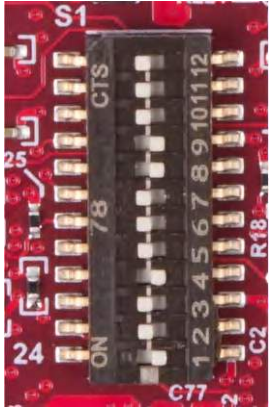
Table 2-15. LEDs Information

Reference Designator	Color	Usage	Comments	Image
DS1	Yellow	nRESET	This LED is used to indicate the state of nRESET pin. If this LED is glowing, the device is out of reset. This LED will glow only after the 5-V supply is provided.	 <p>Figure 2-29. DS1</p>
DS2	Yellow	GPIO_2	Glowes when the GPIO_2 is logic 1	 <p>Figure 2-30. DS2</p>
DS3	Red	NERROUT	Glowes if there is any HW error in the xWR device	 <p>Figure 2-31. LEDs</p>
DS4	Red	POWER	This LED indicates the presence of the 5-V supply.	
D5	Yellow	SOR0	SOR0 (SOP2) state	
D6	Yellow	SOR1	SOR1 (SOP1) state	
D7	Yellow	SOR2	SOR2 (SOP0) state	
D8	Red	NRST	This LED is used to indicate the state of NRST pin. If this LED is glowing, the device is in reset state.	
D10	Red	POWER	3V3 supply indication	
D4	Yellow	FTDI	Glowes if the USB is in suspend mode	 <p>Figure 2-32. D4 & D9</p>
D9	Red	POWER	5-V supply indication (from USB bus)	
D11	Green	POWER	5-V supply indication if the input voltage to board is more than 5 V	 <p>Figure 2-33. D11 & D14</p>
D14	Green	POWER	3V3 supply indication	

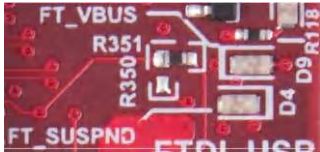
3 xWR6843ISK / IWR6843ISK-ODS REV C

Figure 3-1 and Figure 3-2 shows the front and rear view of xWR6843ISK EVM, respectively. This EVM includes onboard etched long range antennas for the four receivers and three transmitters. The xWR6843 operates at a 4-GHz bandwidth from 60 to 64 GHz, with a maximum output power of 10 dBm; the xWR6843ISK has an antenna gain of ~7 dBi and the IWR6843ISK-ODS has an antenna gain of ~5 dBi.

Note

This chapter applies to Rev. C and up of the AWR6843ISK, IWR6843ISK, and IWR6843ISK-ODS.

3.1 Hardware



CAUTION HOT SURFACE
CONTACT MAY CAUSE BURN
DO NOT TOUCH

3.1.1 xWR6843ISK EVM

Note

The xWR6843ISK has been tested in the 60-64GHz band across the temperature range of -20°C to 60°C. The device is intended for use within the aforementioned limits.

Note

In accordance to the EN 62311 RF exposure test, a minimum separation distance of 20 centimeters should be maintained between the user and the EVM during operation.

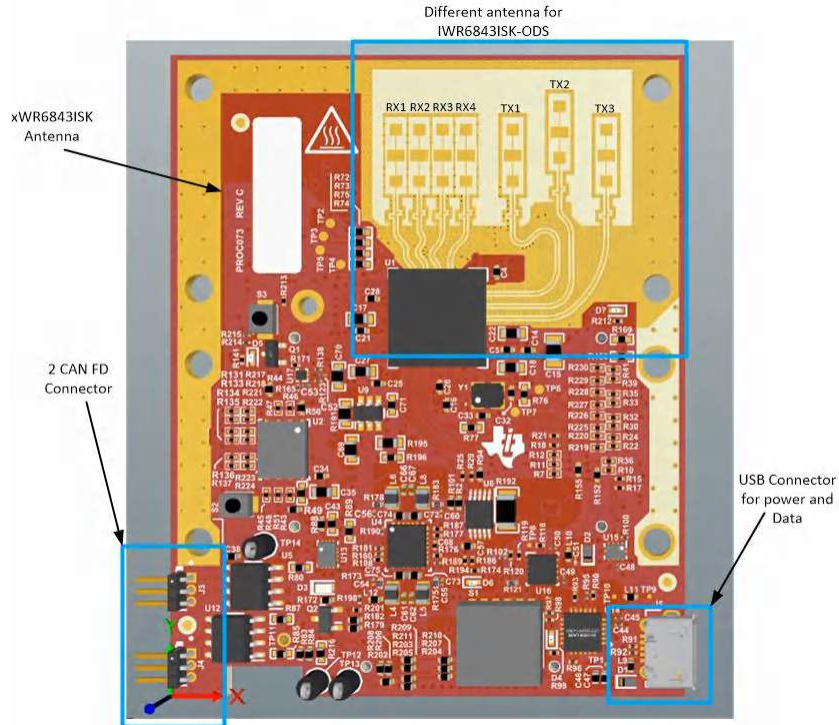

Figure 3-1. xWR6843ISK Front View

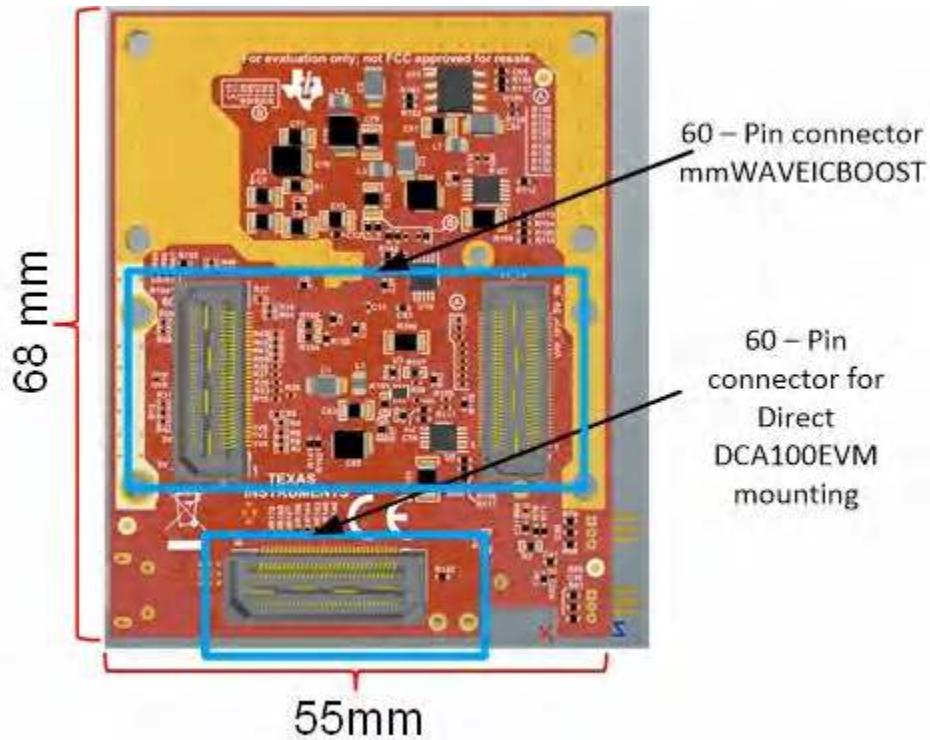

Figure 3-2. xWR6843ISK Rear View

3.1.2 IWR6843ISK-ODS EVM

The IWR6843ISK-ODS includes onboard-etched short range wide field of view antennas for the four receivers and three transmitters. [Figure 3-3](#) shows the PCB antennas.

Note

The IWR6843ISK-ODS has been tested in the 60-64GHz band across the temperature range of -20°C to 60°C.

Note

In accordance to the EN 62311 RF exposure test, a minimum separation distance of 20 centimeters should be maintained between the user and the EVM during operation.

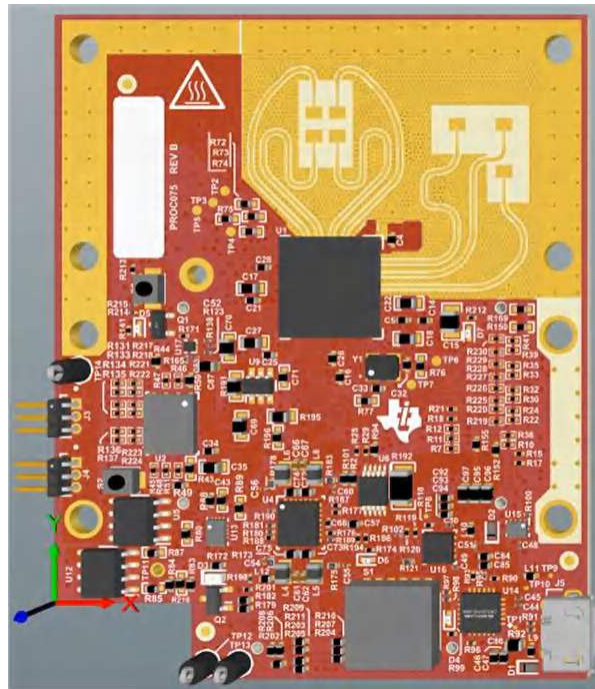

Figure 3-3. PCB Antenna – Top

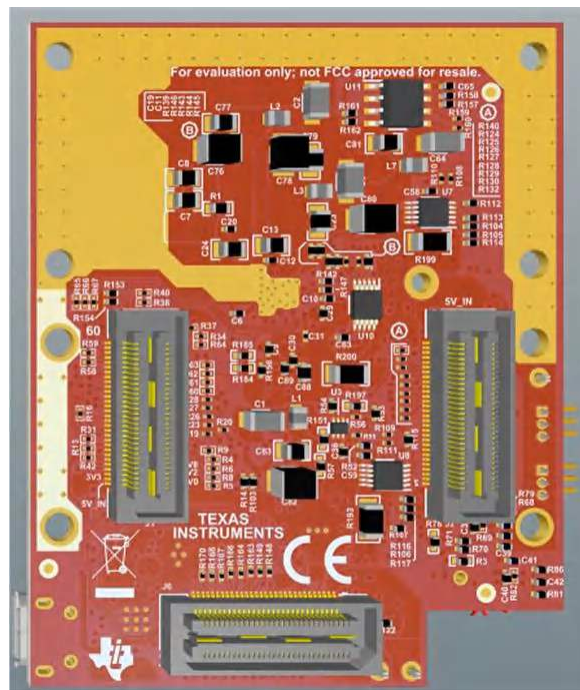

Figure 3-4. PCB Antenna – Bottom

3.2 xWR6843ISK/IWR6843ISK-ODS Block Diagram

Figure 3-5 shows the functional block diagram.

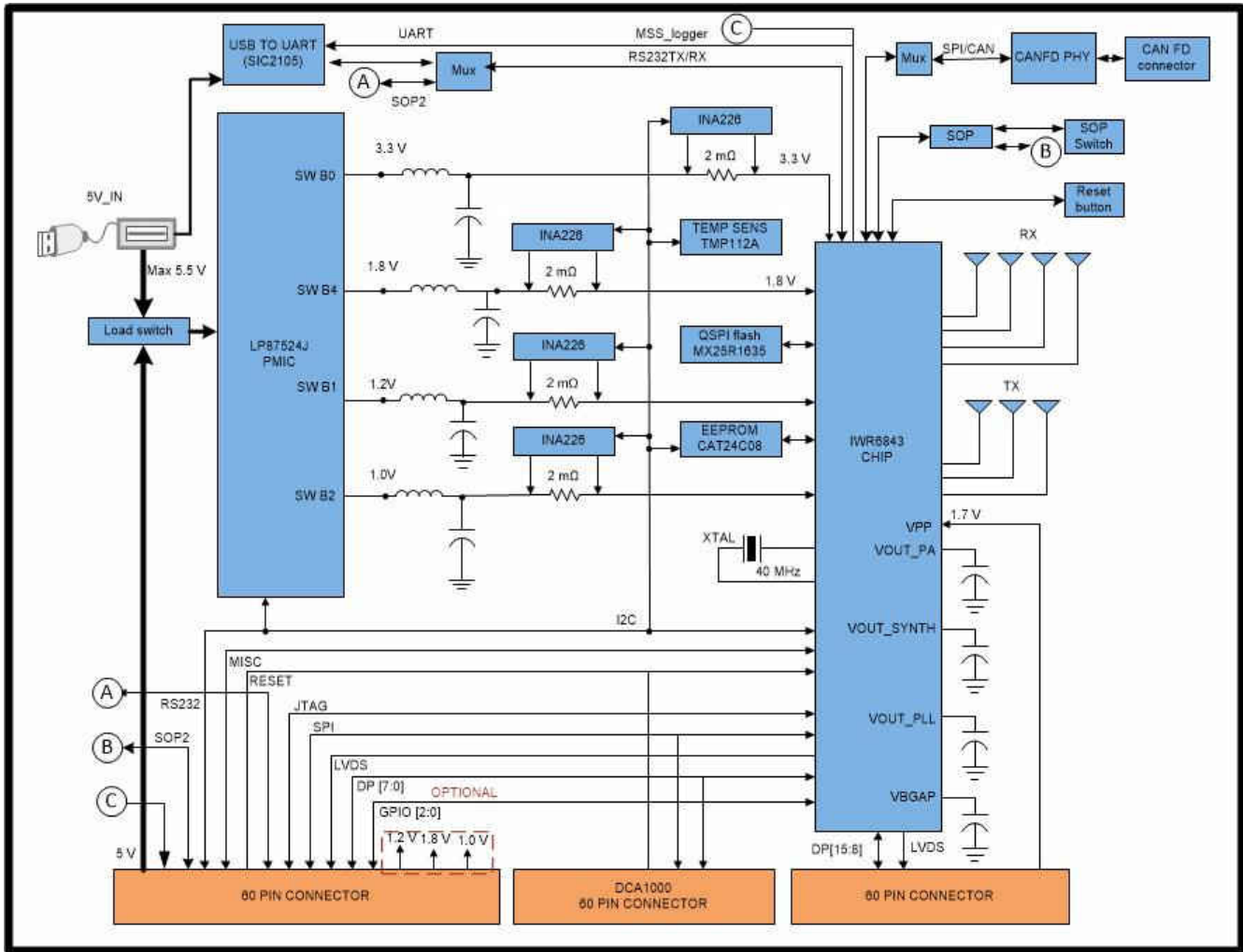

Figure 3-5. Block Diagram of xWR6843ISK/IWR6843ISK-ODS

3.3 PCB Storage and Handling Recommendations

The immersion silver finish of the PCB provides a better high-frequency performance, but is also prone to oxidation in open environments. This oxidation causes the surface around the antenna region to blacken.

To avoid oxidation, the PCB should be stored in an ESD cover and kept at a controlled room temperature with low humidity conditions. All ESD precautions must be taken while using and handling the EVM.

3.4 Power Connections

The antenna module is powered by the 3.3 V from the 60-pin HD connectors. When power is supplied, an on-board PMIC and LDO generate the voltages. The PGOOD LED glows to indicate all voltage rails are in limits.

Note

After the 3.3-V supply is provided to the EVM, TI recommends toggling the NRST signal once to ensure a reliable boot-up state; this signal is accessible on the 60-pin HD connector.

3.4.1 Higher Power Applications

For higher power application tespoint T13 (5V) and T12 (GND) can be used to supply power the EVM.

3.5 Interfaces

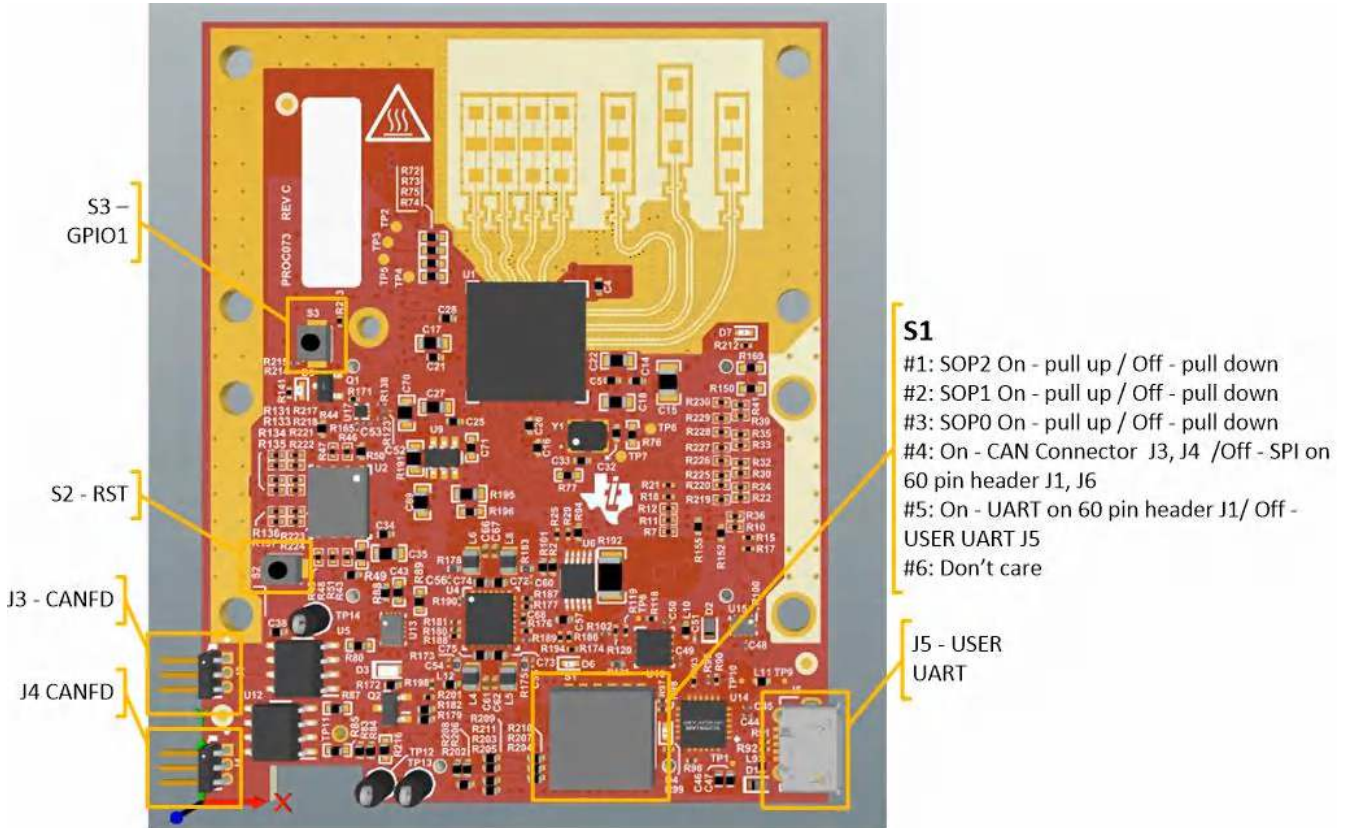

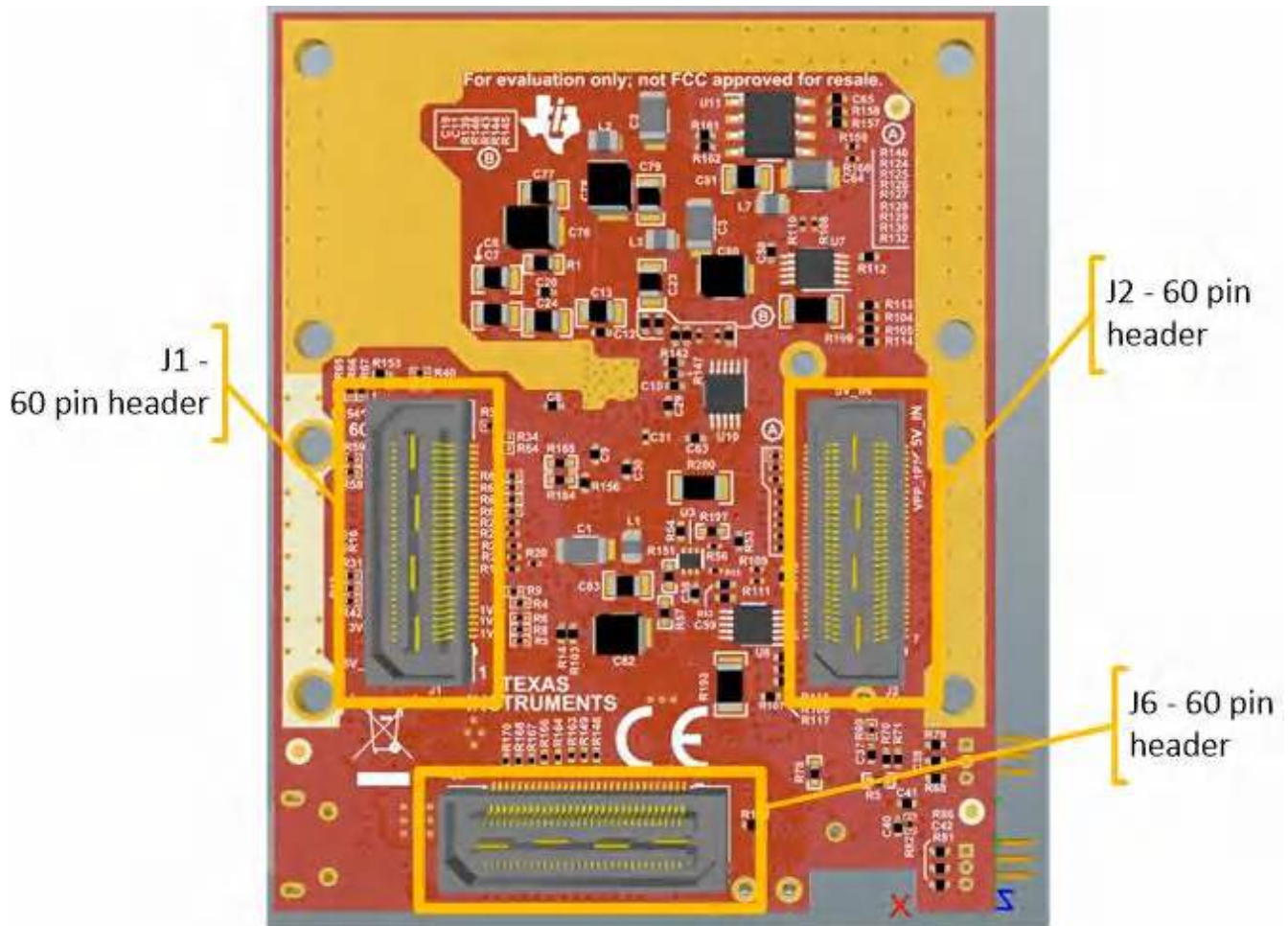

3.5.1 Switches, Buttons and Muxes

Reference Designator	Switch ON	Switch OFF
S1.1	SOP2 pulled up	SOP2 pulled down
S1.2	SOP1 pulled up	SOP1 pulled down
S1.3	SOP0 pulled up	SOP0 pulled down
S1.4	Muxes to CAN connector J3, J4	Muxes to SPI on 60 pin connector J1, J6
S1.5	Muxes USER UART to 60 pin header J1	Muxes USER UART to USB connector J5
S1.6	-	-
S2	Reset Switch	
S3	GPIO1 toggle switch	

3.5.2 List of LEDs

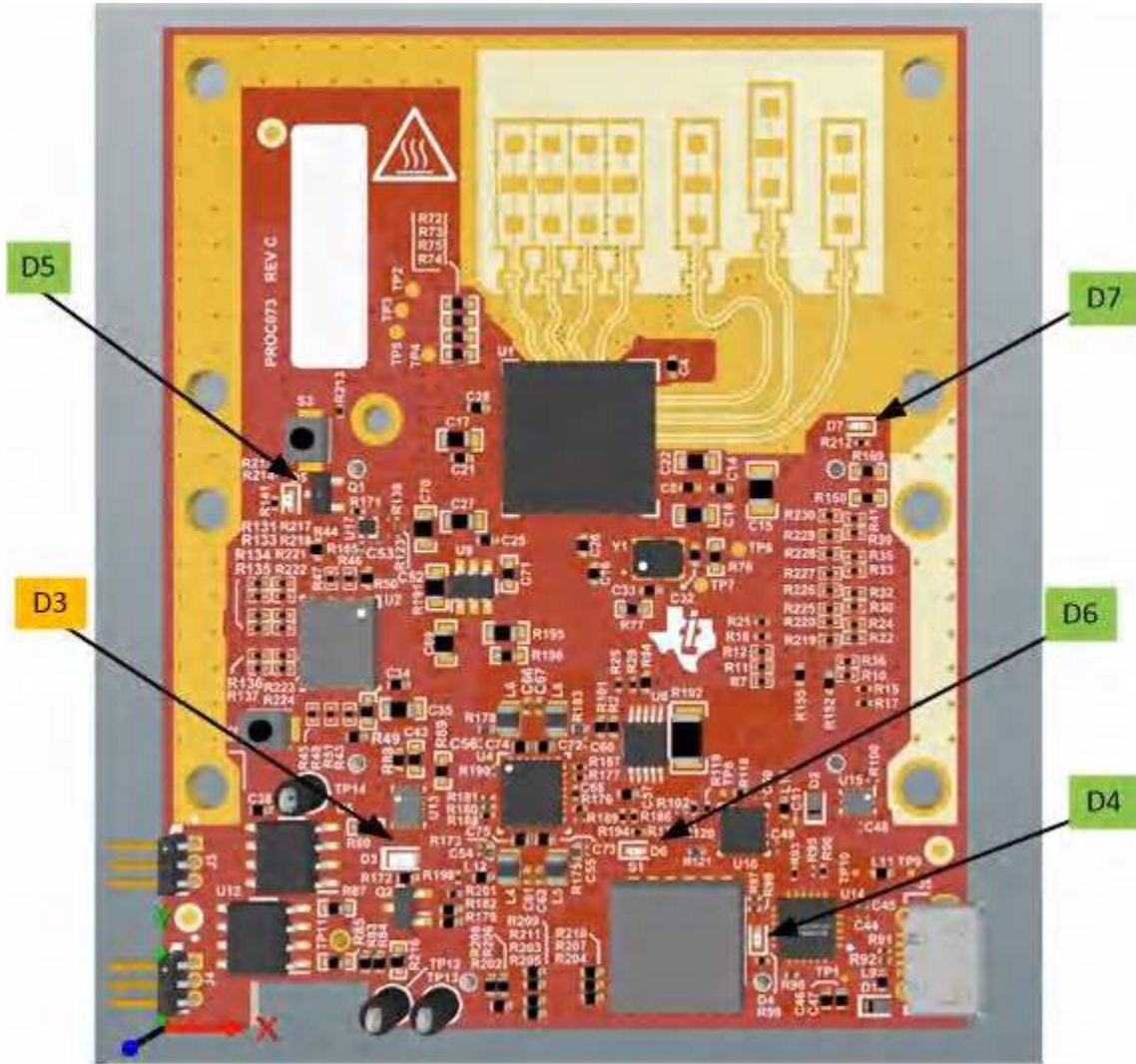

Figure 3-6. LED location and color

Table 3-1 shows the list of LEDs.

Table 3-1. List of LEDs

Reference Designator	Color	Usage	Comments
D3	Orange	Power Good	This LED is used to indicate the PGOOD. If this LED is glowing means that all voltage rails are in limits.
D4	Green	USB enumeration LED	Turns on while enumerating the USB
D5	Green	Reset	Toggles when reset button is depressed
D6	Green	5V indicator	Indicates the application of 5V power
D7	Green	GPIO 2	Connected to GPIO2, can be used when GPIO is set as output

3.5.3 CANFD

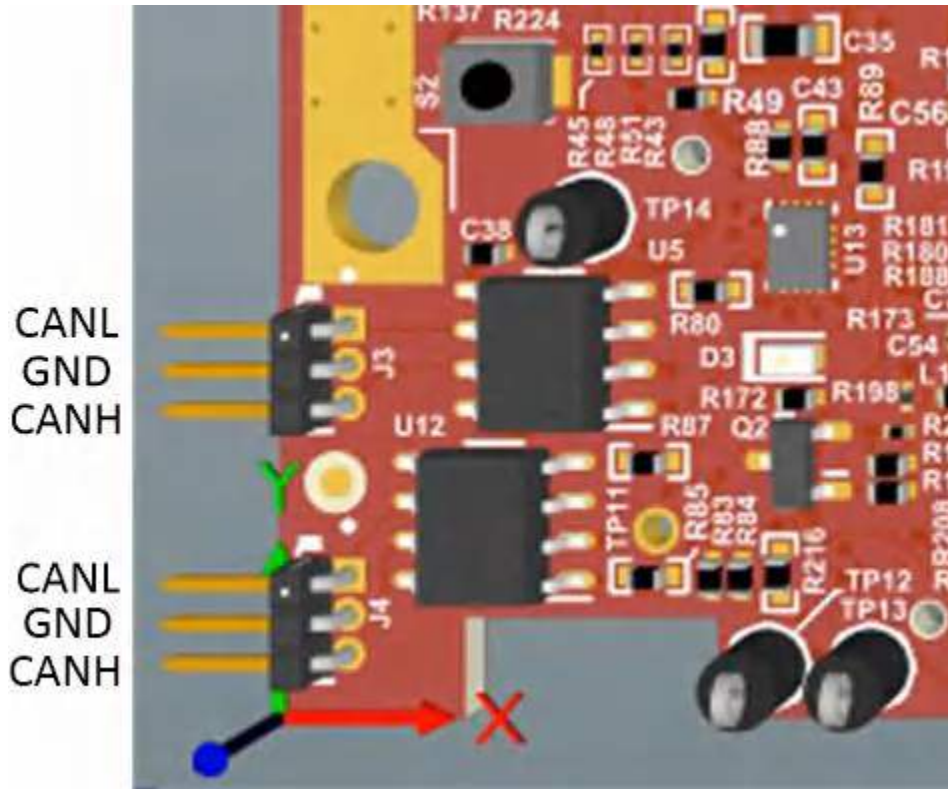

Figure 3-7. CAN Connector location and label

The J3 and J4 connectors shown in [Figure 3-7](#) provide the CAN_L and CAN_H signals from the 2 onboard CAND-FD transceivers (TCAN1042HGVDQRQ1). These signals are wired to the CAN bus after muxing with the SPI interface signals; one of the two paths must be selected. Two CANs are selected by closing the switch S1.4 (1st position of switch to be ON).

Pin Description	Device Interface	Connector on Board
SPI_CS1	CAN2_TX	J4.1 - CANL, J4.2 -GND, J4.3 - CANH
SPI_CLK1	CAN2_RX	
MISO_1	CAN1_TX	J3.1 - CANL, J3.2 -GND, J3.3 - CANH
MOSI_1	CAN1_RX	

3.5.4 I2C Connections

The board features an EEPROM, current sensor, and temperature sensor for measuring on-board temperature. These are connected to the I2C bus and can be isolated using the zero Ω provided on the hardware.

3.5.4.1 EEPROM

The board features an EEPROM for storing the board specific IDs (for the identification of the starter kit connected to the MMWAVEICBOOST).

3.5.4.2 Default I2C Address

[Table 2-11](#) provides the list of I2C devices and its address.

Table 3-2. IWR6843ISK I2C Devices and Address

Sensor Type	Reference Designator	Part Number	Slave Address
Temperature Sensor	U3	TMP112AQDRLRQ1	100 1011
EEPROM	U11	CAT24C08WI-GT3	101 00XX ⁽¹⁾
Current sensor1	U6	INA226AIDGST	100 0000

Table 3-2. IWR6843ISK I2C Devices and Address (continued)

Sensor Type	Reference Designator	Part Number	Slave Address
Current sensor2	U7	INA226AIDGST	100 0101
Current sensor3	U8	INA226AIDGST	100 0001
Current sensor4	U10	INA226AIDGST	100 0100
PMIC	U4	LP87702DRHBRQ1	110 0000

(1) XX means 00,01,10,11

3.6 xWR6843ISK Antenna

The xWR6843ISK includes onboard-etched long range antennas for the four receivers and three transmitters. [Figure 3-8](#) shows the PCB antennas.

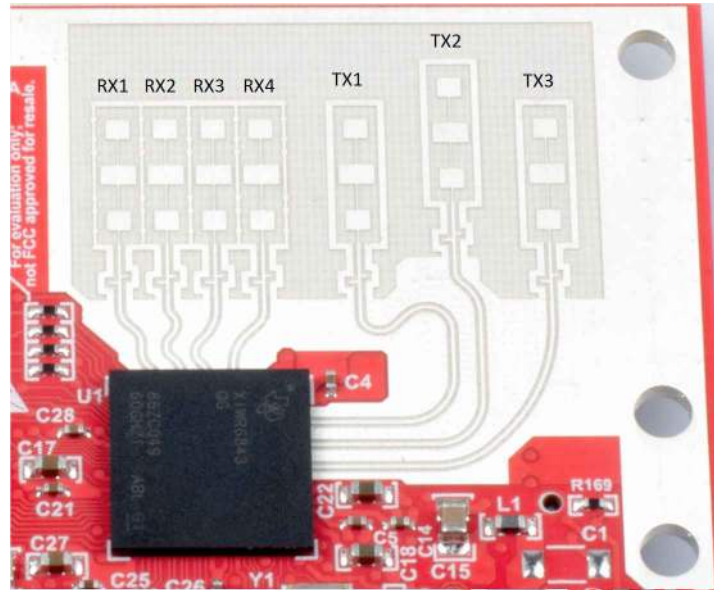

Figure 3-8. PCB Antennas

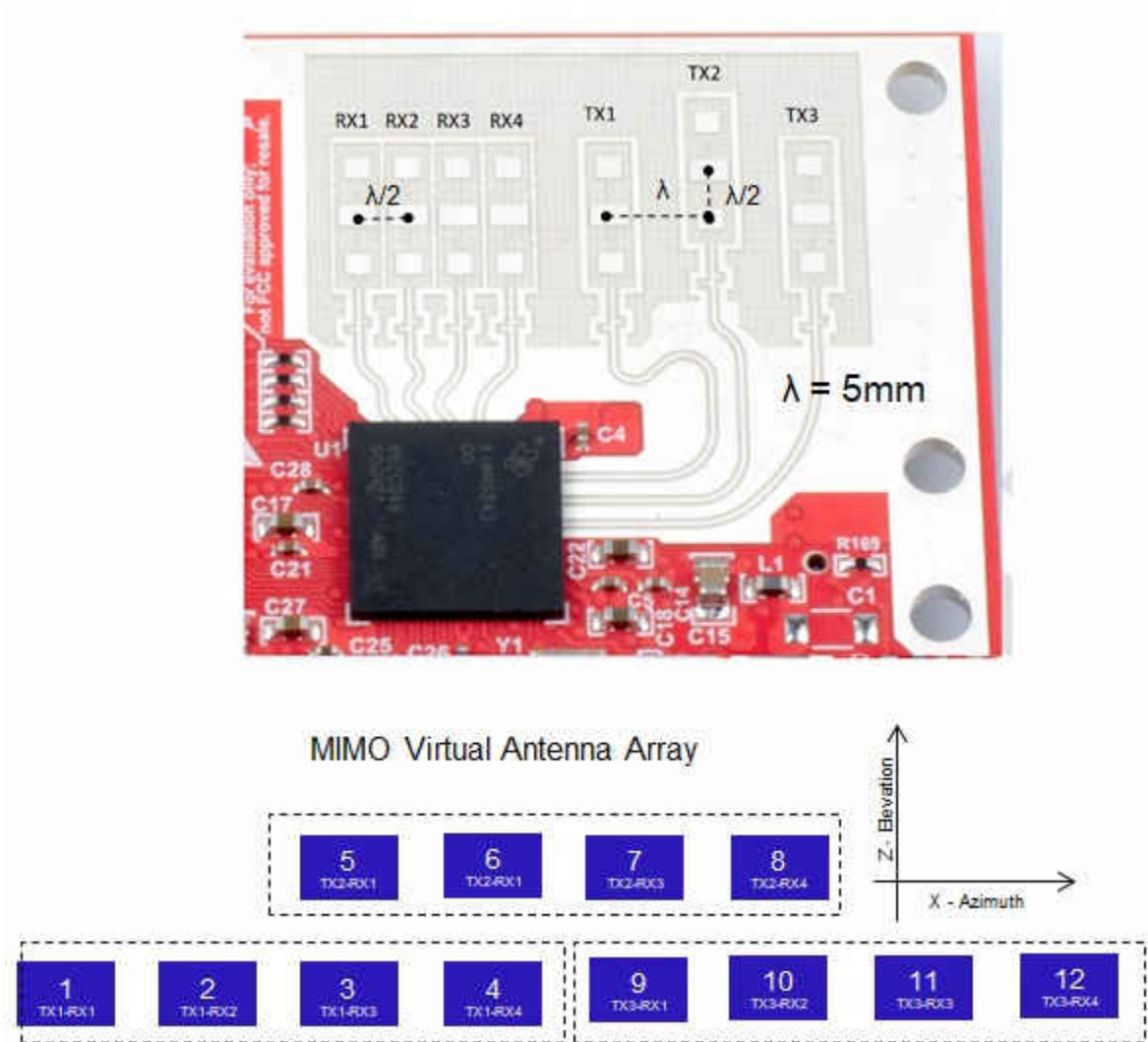

Figure 3-9. IWR6843ISK antenna placement MIMO array

Figure 3-10 through Figure 3-12 shows the antenna radiation pattern with regard to azimuth. Figure 3-13 through Figure 3-15 show the antenna radiation pattern with regard to elevation for TX1, TX2, and TX3.

All of the measurements were done with a Tx and Rx combination together. Thus, for the -6dB beam width, you must see a -12db (Tx (-6dB) + Rx(-6dB)) number.

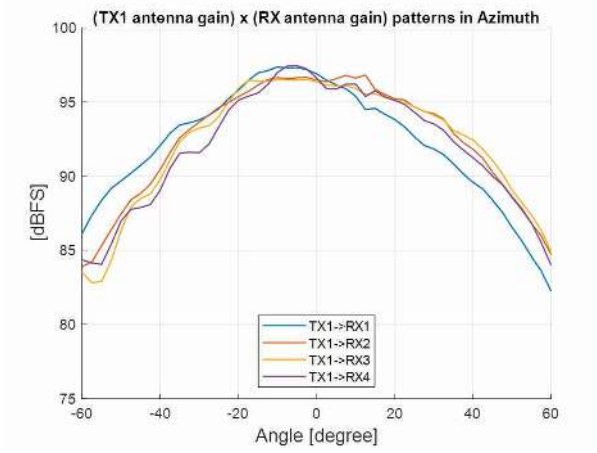

Figure 3-10. TX1 Antenna Radiation Pattern in Azimuth

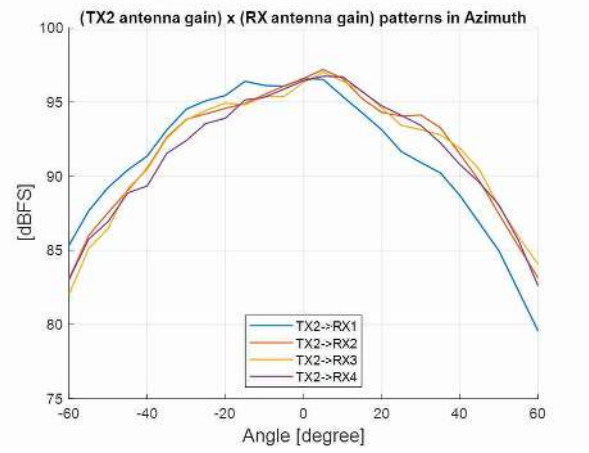

Figure 3-11. TX2 Antenna Radiation Pattern in Azimuth

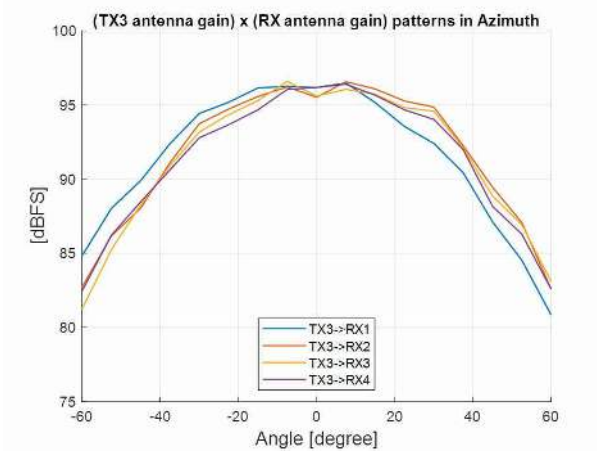

Figure 3-12. TX3 Antenna Radiation Pattern in Azimuth

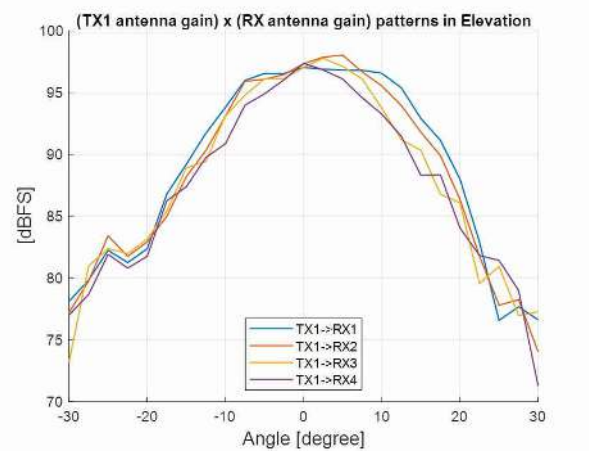

Figure 3-13. TX1 Antenna Radiation Pattern in Elevation

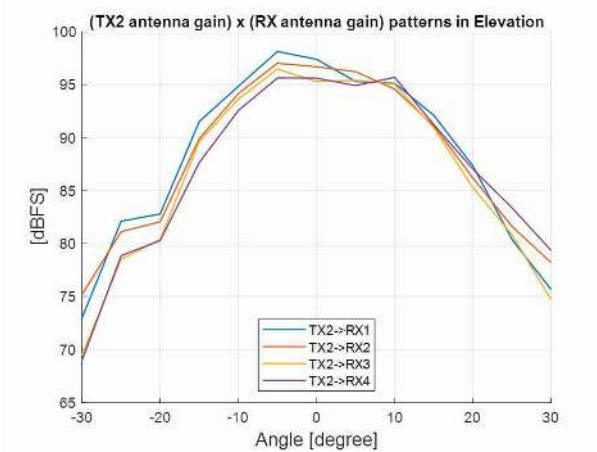

Figure 3-14. TX2 Antenna Radiation Pattern in Elevation

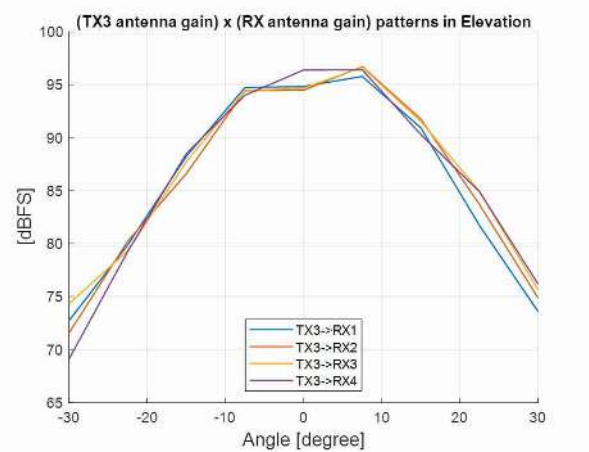

Figure 3-15. TX3 Antenna Radiation Pattern in Elevation

3.7 IWR6843ISK-ODS Antenna

The IWR6843ISK-ODS includes on-board-etched short range antennas (approximately 12-15 meters for people detection) for the four receivers and three transmitters. Figure 3-16 shows the PCB antennas arrangement. This provides equal angular resolution both in Azimuth and Elevation directions with the help of 4×3 virtual antennas positions.

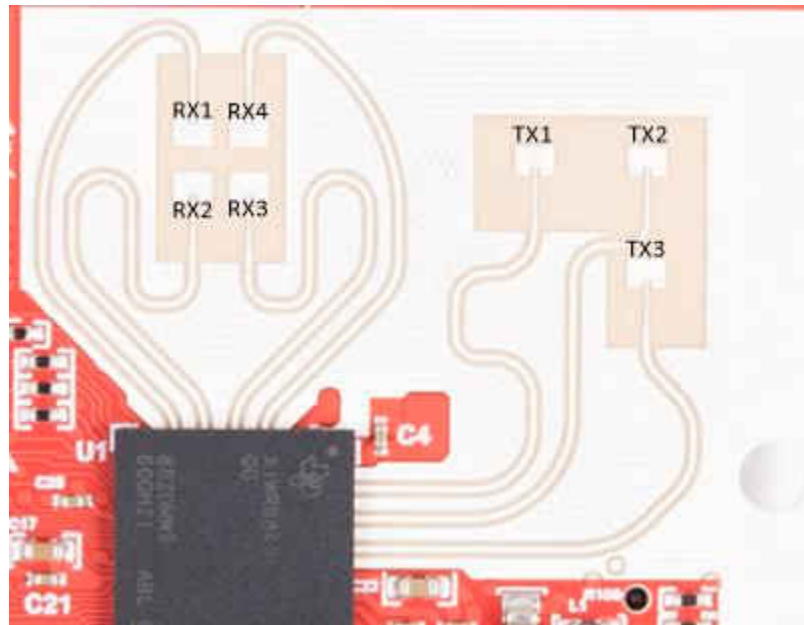
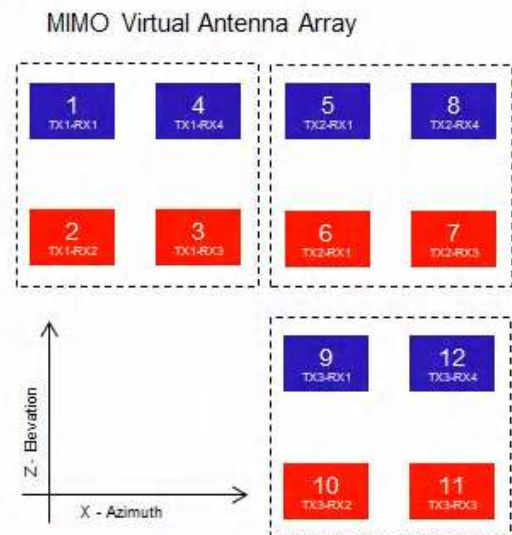
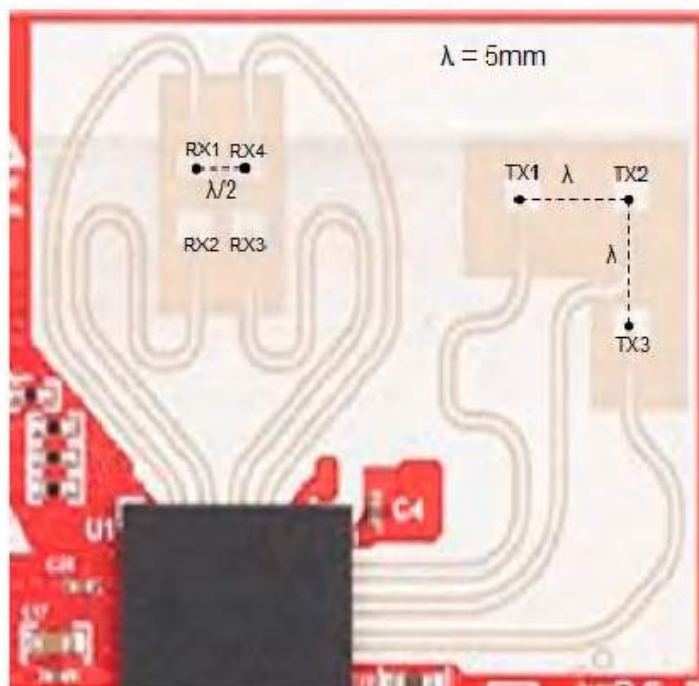

Figure 3-16. IWR6843ISK-ODS PCB Antenna



RX2 and RX3 are 180° out of phase with respect to RX1 and RX4. Because of this, a 180° phase inversion needs to be applied in software processing for the corresponding virtual RX channels (highlighted in Red)

Figure 3-17. IWR6843ISK-ODS antenna placement MIMO array

Figure 3-18 shows combined Antenna Radiation pattern in the Azimuth plane for all the transmitter and receiver pairs together (TX[1-3]-RX[1-4]).

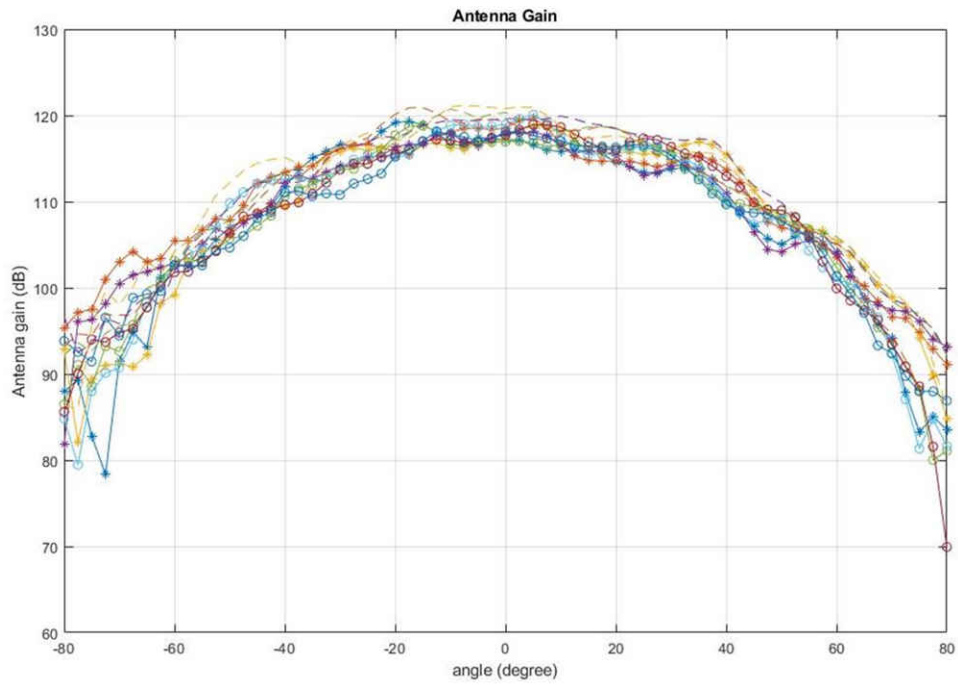

Figure 3-18. Measured Azimuthal Radiation Pattern for All Tx to Rx Pairs (All 12 Virtual Antenna Pairs Included)

Figure 3-19 shows the combined Antenna Radiation pattern in the Elevation plane for all the transmitter and receiver pairs together, TX[1-3]-RX[1-4].

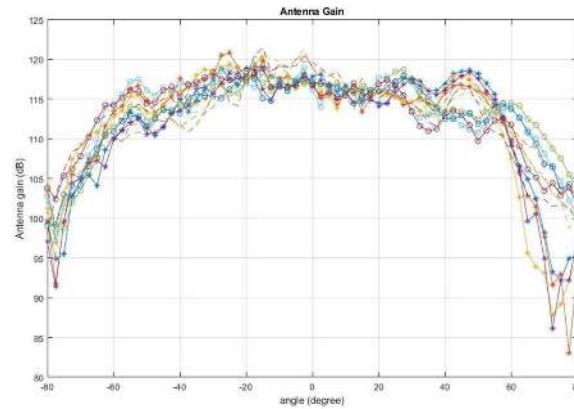

Figure 3-19. Measured Elevation Radiation Pattern for All Tx to Rx Pairs (All 12 Virtual Antenna Pairs Included)

3.8 Modular Mode

When used in modular mode as shown in Figure 3-21, the power is supplied through a single USB connector; the same connector J5 is also used for data transfer through the CP2105 USB to UART emulator.

When enumerated correctly, the 2 UART ports are displayed on the device manager as a Virtual COM Port, similar to that shown in Figure 3-20.

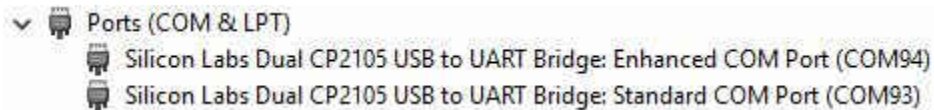

Figure 3-20. Virtual COM port

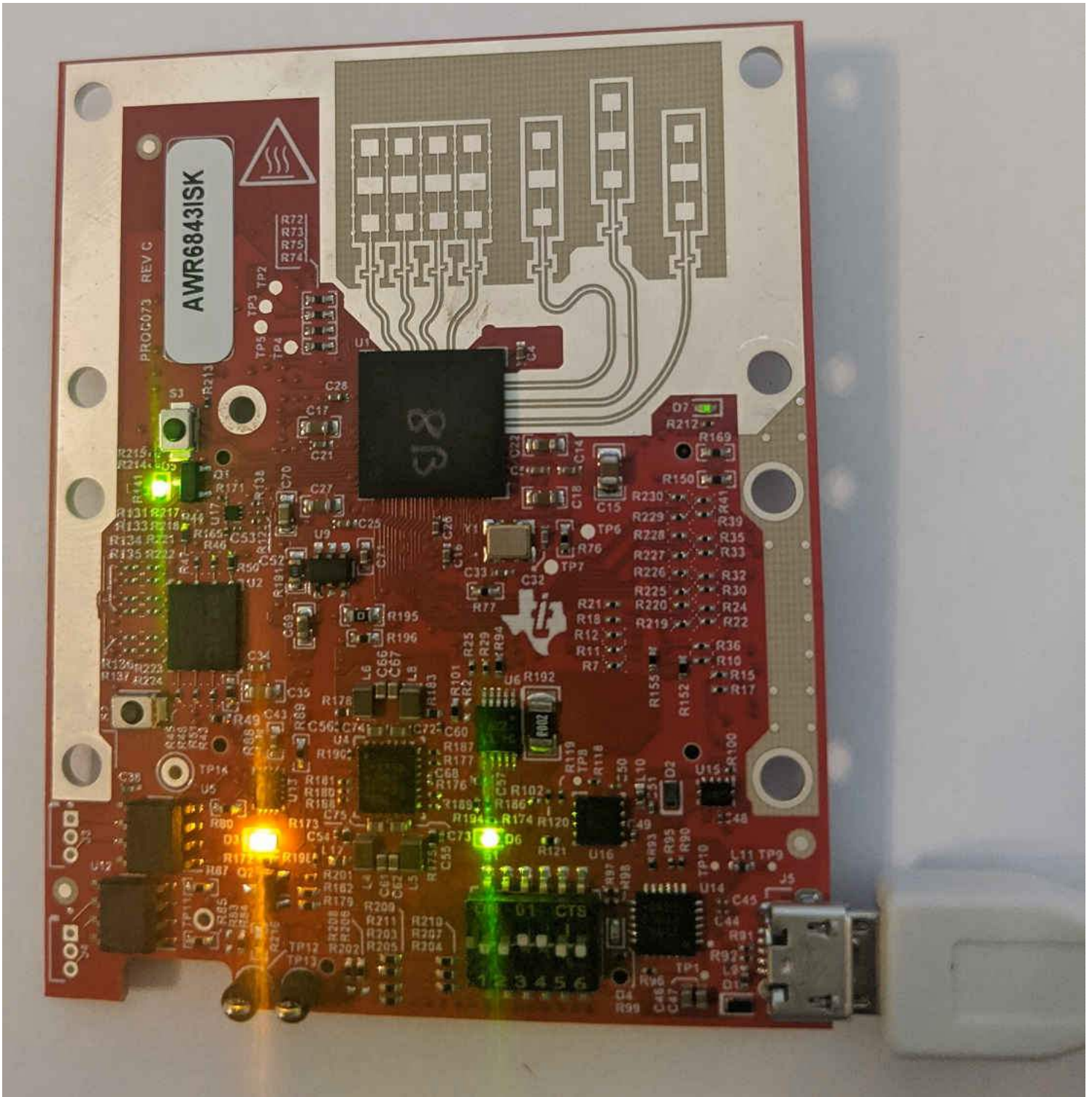

Figure 3-21. Modular Mode Setup

S1 switch setting for functional and flashing mode is shown in [Table 3-3](#).

Table 3-3. S1 Config Flashing and Functional Mode

	s1.1	s1.2	s1.3	s1.4	s1.5	s1.6
Flashing	On	Off	On	On	Off	-
Functional	Off	Off	On	On	Off	-

3.9 DCA1000EVM Mode

The setup for raw data capture using DCA1000EVM is shown in [Figure 3-22](#)



Figure 3-22. DCA1000EVM mode

S1 switch settings for this mode is shown in [Table 3-4](#)

Table 3-4. S1 Config for DCA1000EVM mode

	S1.1	S1.2	S1.3	S1.4	S1.5	S1.6
DCA1000EVM mode	OFF	ON	ON	OFF	OFF	-

3.10 MMWAVEICBOOST Mode

In this mode the boards are setup as shown in [Figure 3-23](#), UART is routed to the 60 pin connector to the XDS110 USB. More on the mmWAVEICBOOST, setup and features it provides can be found in [Section 2](#)

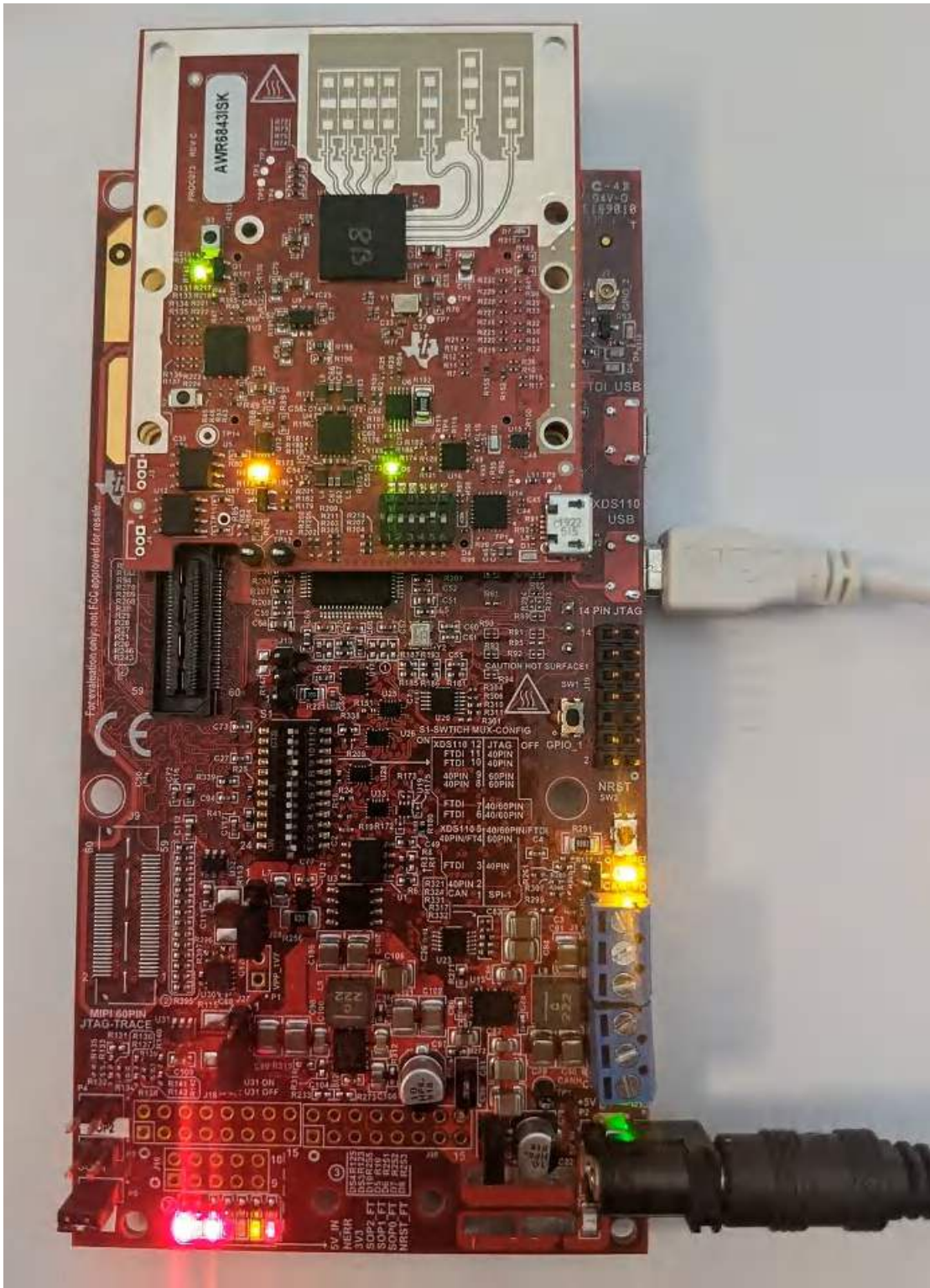

Figure 3-23. mmWAVEICBOOST mode

S1 switch settings for mmWAVEICBOOST mode is shown in [Table 3-5](#)

Table 3-5. S1 Config for mmWAVEICBOOST mode

	S1.1	S1.2	S1.3	S1.4	S1.5	S1.6
mmWAVEICBOOST mode	Off	Off	Off	Off	On	-

4 xWR6843AOPEVM Rev G



CAUTION HOT SURFACE
CONTACT MAY CAUSE BURN
DO NOT TOUCH

Note

RECOMMENDED DUTY CYCLE: The xWR6843AOPEVM operates at a maximum duty cycle of 50%: running at a higher duty cycle increases the risk of damaging the EVM by exceeding the maximum operating junction temperature (T_j) of 105°C.

Note

This chapter applies to the AWR6843AOPEVM and IWR6843AOPEVM

4.1 Hardware

The xWR6843AOPEVM includes four receivers and three transmitters with wide field of antennas on the package of the device. The IWR6843AOP and AWR6843AOP operate at a 4-GHz bandwidth from 60 to 64 GHz, with a maximum output power of 10 dBm and an antenna gain of ~5 dBi.

Note

The xWR6843AOPEVM has been tested in the 60 - 64GHz frequency range across the ambient temperature range of -20°C to 60°C.

Note

In accordance to the EN 62311 RF exposure test, a minimum separation distance of 20 centimeters should be maintained between the user and the EVM during operation.

Note

Refer to the [Thermal Design Guide for Antenna on Package mmWave Sensor](#) application note for details of thermal dissipation options for xWR6843 AOP devices, particularly for small form factor designs such as the mission side of the EVM.

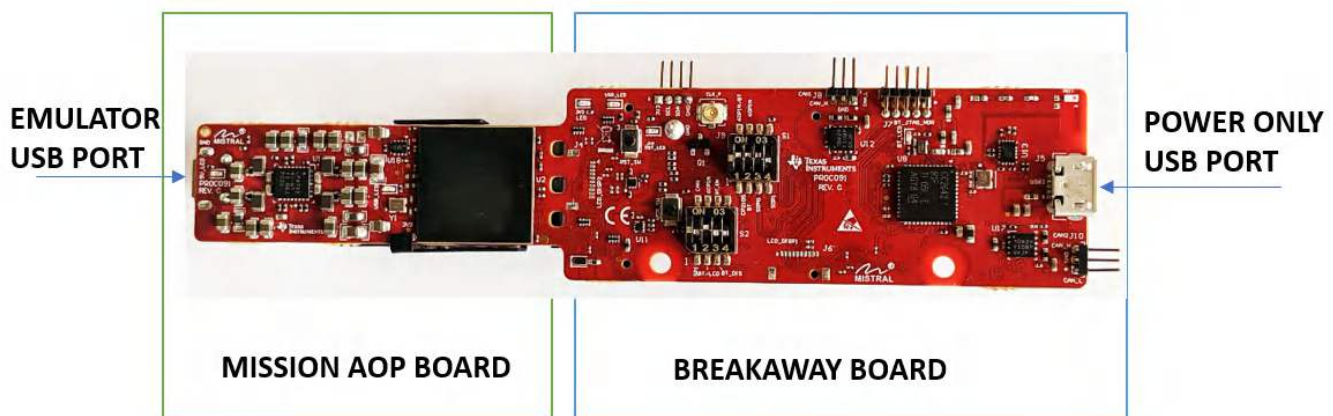

Figure 4-1. xWR6843AOPEVM Top View

The following features are available on the mission AOP board of the xWR6843AOPEVM:

- 60-GHz to 64-GHz mmWave sensing for form-factor deployment and testing

- Functional and flashing SOP Mode
- Emulator USB port for user UART and Data COM ports

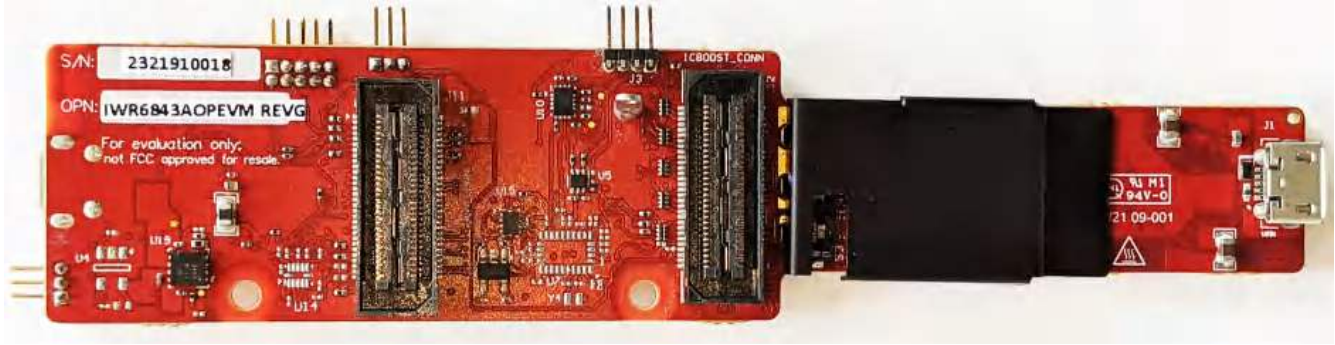

Figure 4-2. xWR6843AOPEVM Bottom View

CAUTION

There is a possibility of damage and loss of function to the mission board when it is split. When split, the board cannot be put back together and many features are lost; see the [Section 5.1](#) section for features available on the mission board. Raw data capture, JTAG debug and other features requiring the 60 pin SAMTEC connectors are permanently lost.

4.2 Block Diagram

Figure 4-3 shows the functional block diagram. The mission board side contains the essential components for the TI radar system namely PMIC, SFLASH, SOP configuration, Filter, TI mmWave Radar chip, and a USB to UART converter. The Breakaway board sections contain the 60-pin Samtec connector for interfacing with the MMWAVEICBOOST. On the REVG, an additional 60-pin connector is provided to directly connect to DCA1000EVM.

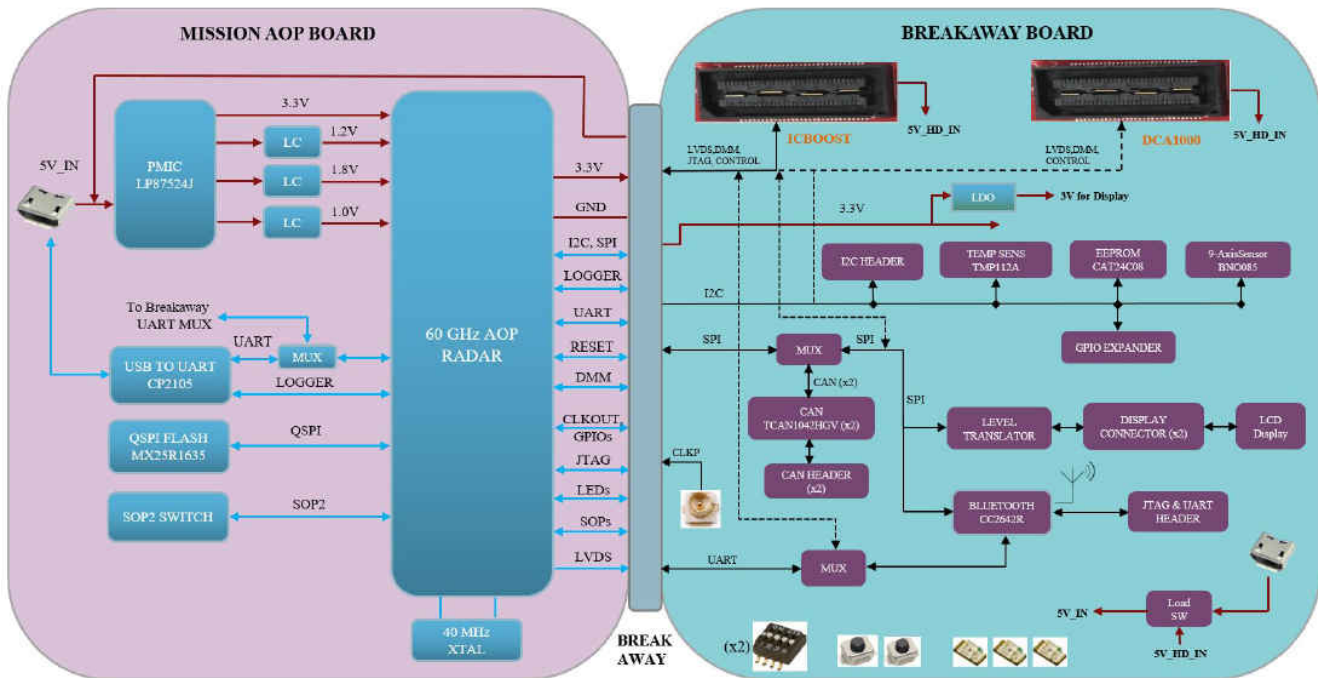

Figure 4-3. Block Diagram of the xWR6843AOPEVM

4.3 PCB Storage and Handling Recommendations

This EVM contains components that can potentially be damaged by electrostatic discharge. Always transport and store the EVM in its supplied ESD bag when not in use. Handle using an antistatic wristband. Operate on an antistatic work surface. For more information on proper handling, refer to [SSYA010A](#).

4.4 Heat Sink and Temperature

Users are strongly encouraged to use the xWR6843AOPEVM with the heat sink installed. Due to the smaller size of the xWR6843AOPEVM, it is likely to get warmer than other larger sized EVMs on the mmWave Radar portfolio so care must be taken to ensure the junction temperature does not exceed 105°C. [Figure 4-4](#) shows measurement of junction temperature versus duty cycle taken with and without the heat sink. As seen in the plot, the EVM can safely operate up to 50% duty cycle with or without the heat sink. Although the heatsink is not absolutely required, usage of the heat sink provides protection against exceeding the junction temperature at higher duty cycles.

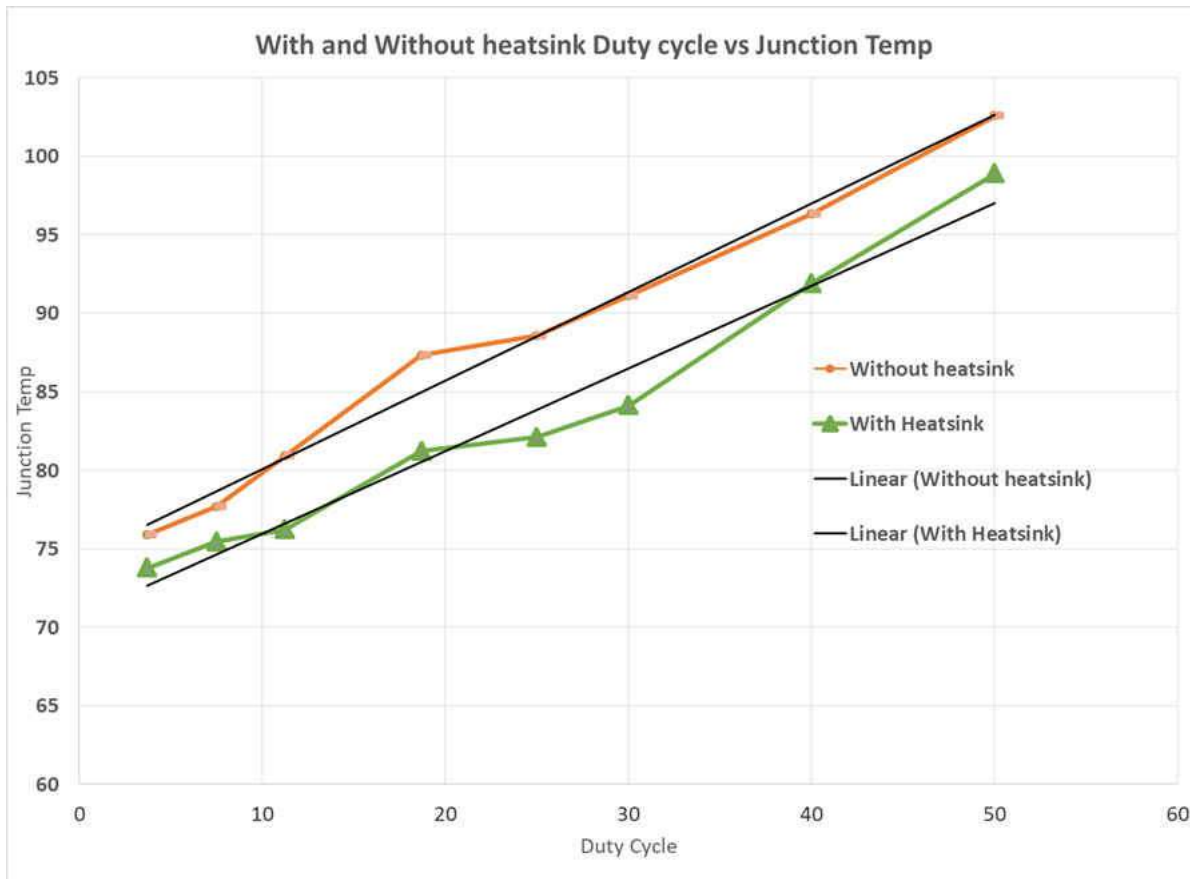

Figure 4-4. Duty Cycle versus Junction Temperature

When using the EVM for custom applications, the duty cycle can be adjusted as needed, the heat sink provided with the kit can be used, customers can also design their own heat sink using better heat dissipating materials or one with more surface area such as addition of fins. The CAD drawing for the heat sink is shown in [Figure 4-5](#).

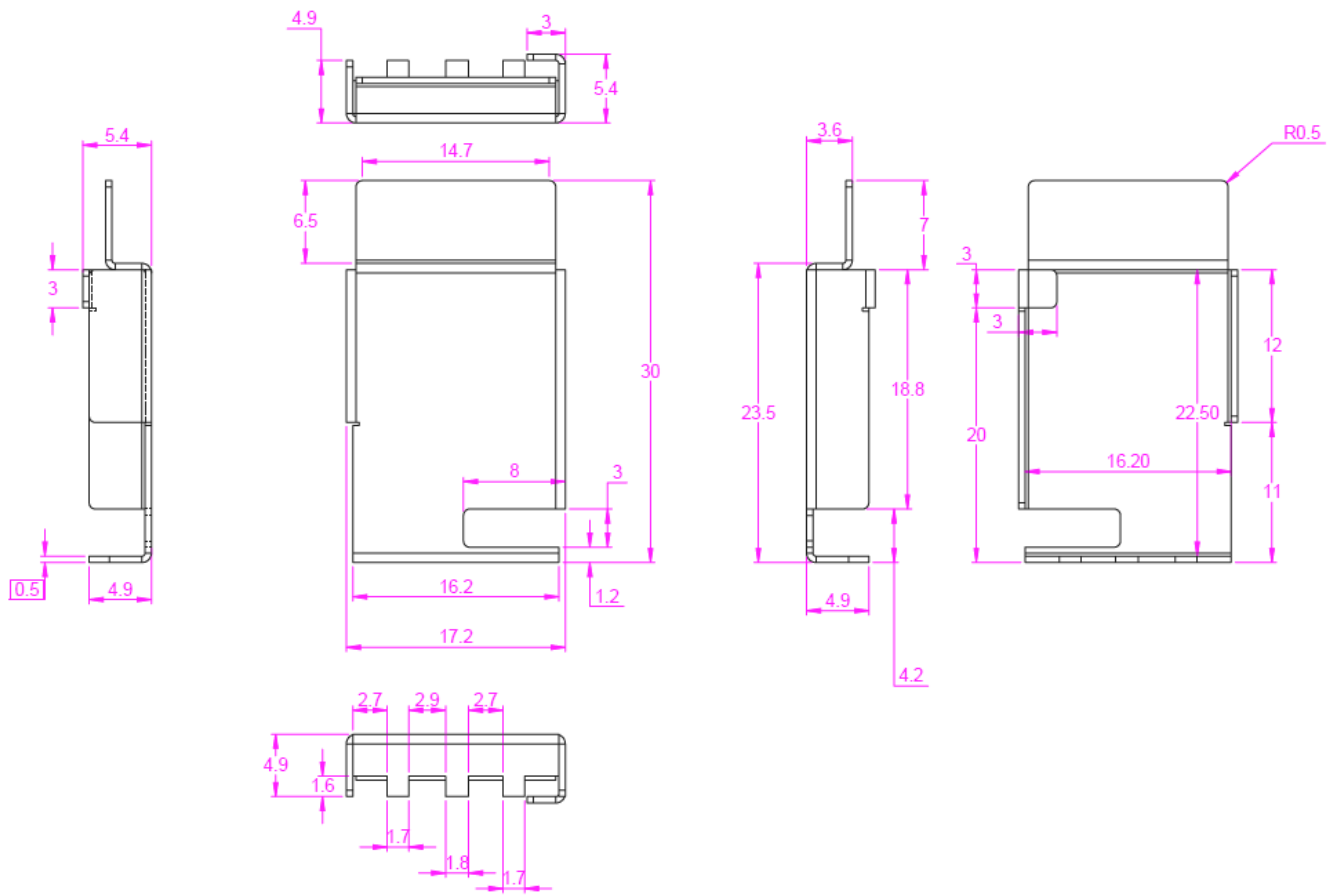

Figure 4-5. Heat sink CAD drawing

Application of the heat sink is shown in [Figure 4-6](#).

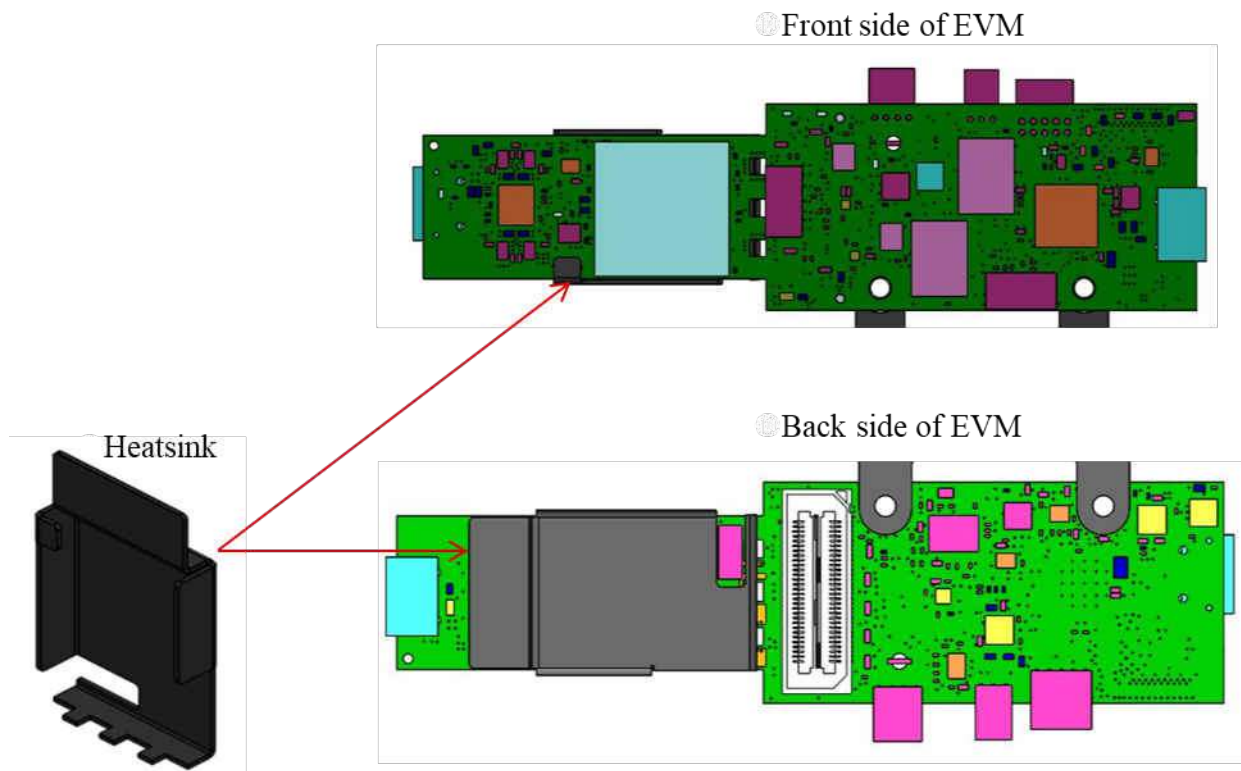

Figure 4-6. Heat sink placement

4.5 xWR6843AOPEVM Antenna

The xWR6843AOPEVM includes four receiver and three transmitter short range antennas on the package of the chip. Figure 4-7 shows the antenna on package.

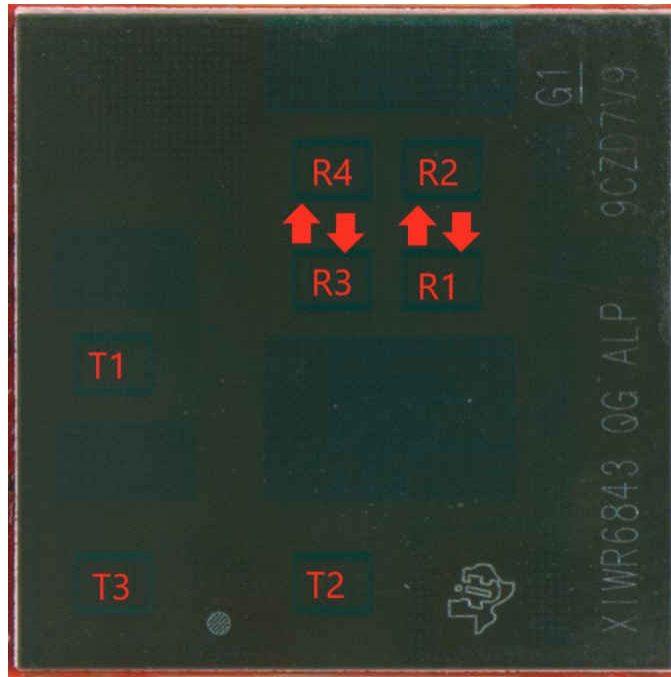

Figure 4-7. AOP Antennas

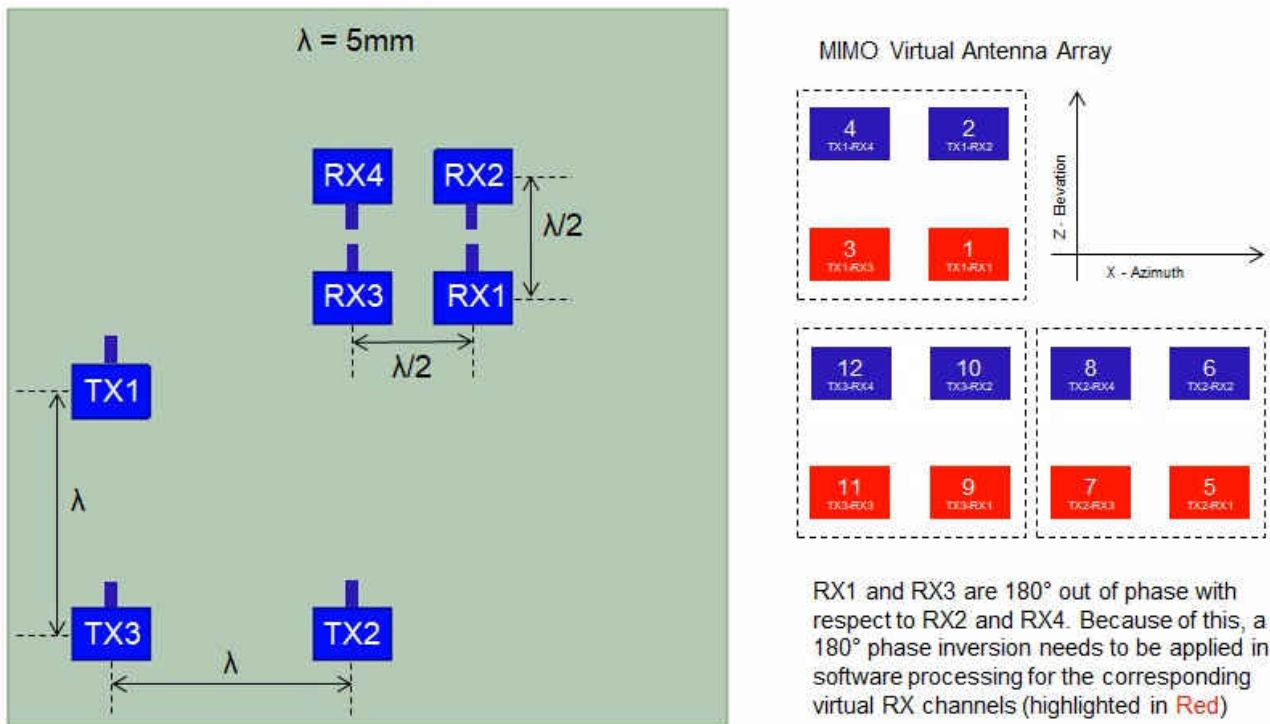

Figure 4-8. IWR6843AOP antenna placement MIMO array

Figure 4-9 shows the antenna radiation pattern with regard to azimuth. Figure 4-10 shows the antenna radiation pattern with regard to elevation for TX1, TX2, and TX3. Both show the radiation pattern for TX1, TX2, and TX3 and RX1, RX2, RX3, and RX4 together.

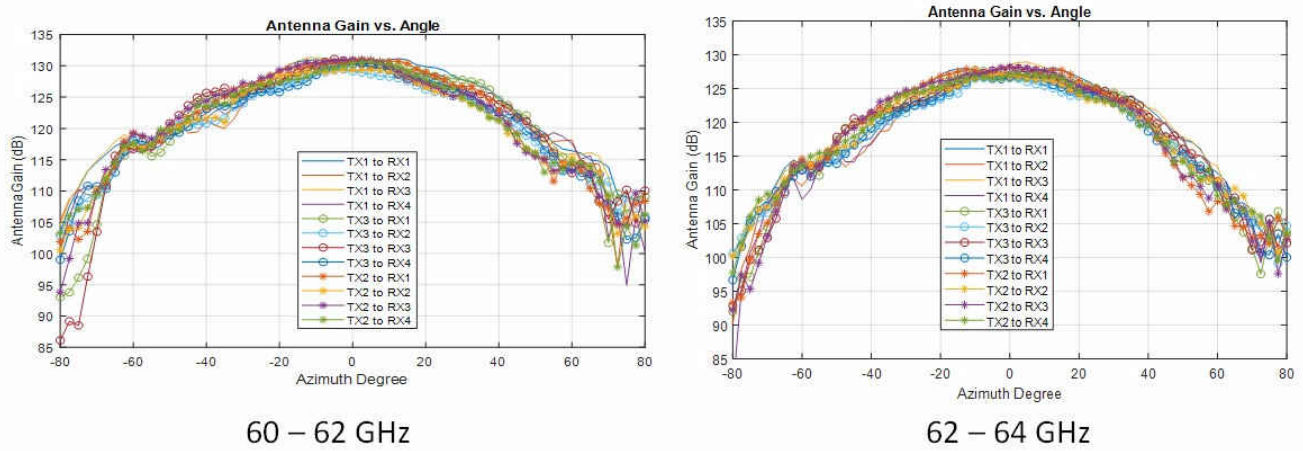

Figure 4-9. Measured Azimuth Radiation Pattern for All Tx to Rx Pairs (All 12 Virtual Antenna Pairs Included)

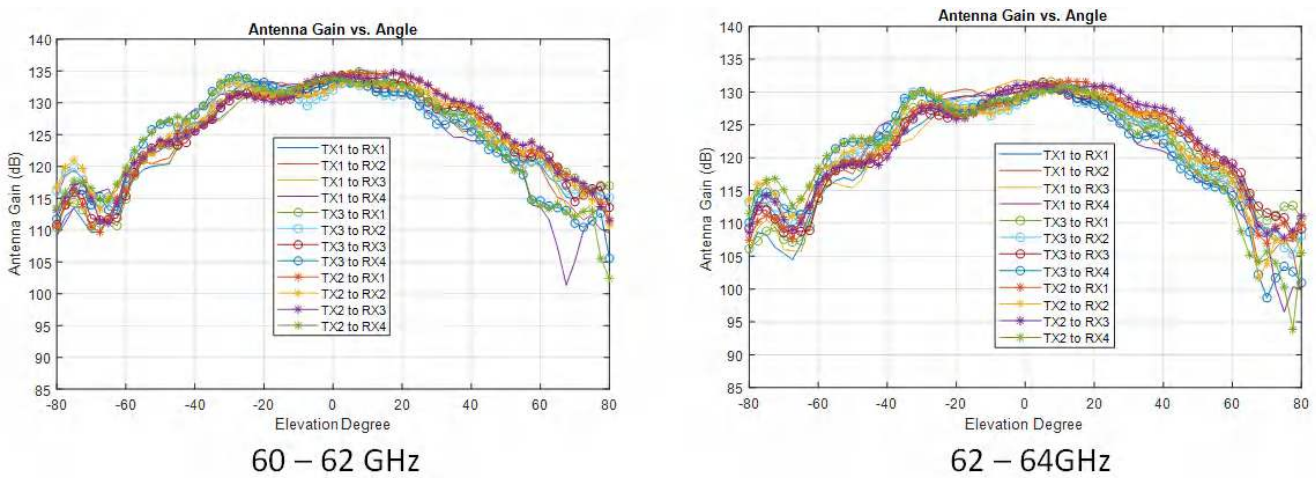

Figure 4-10. Measured Elevation Radiation Pattern for All Tx to Rx Pairs (All 12 Virtual Antenna Pairs Included)

4.6 Switch Settings

Figure 4-11 shows the part designators and positions of the switches on the xWR6843AOPEVM.

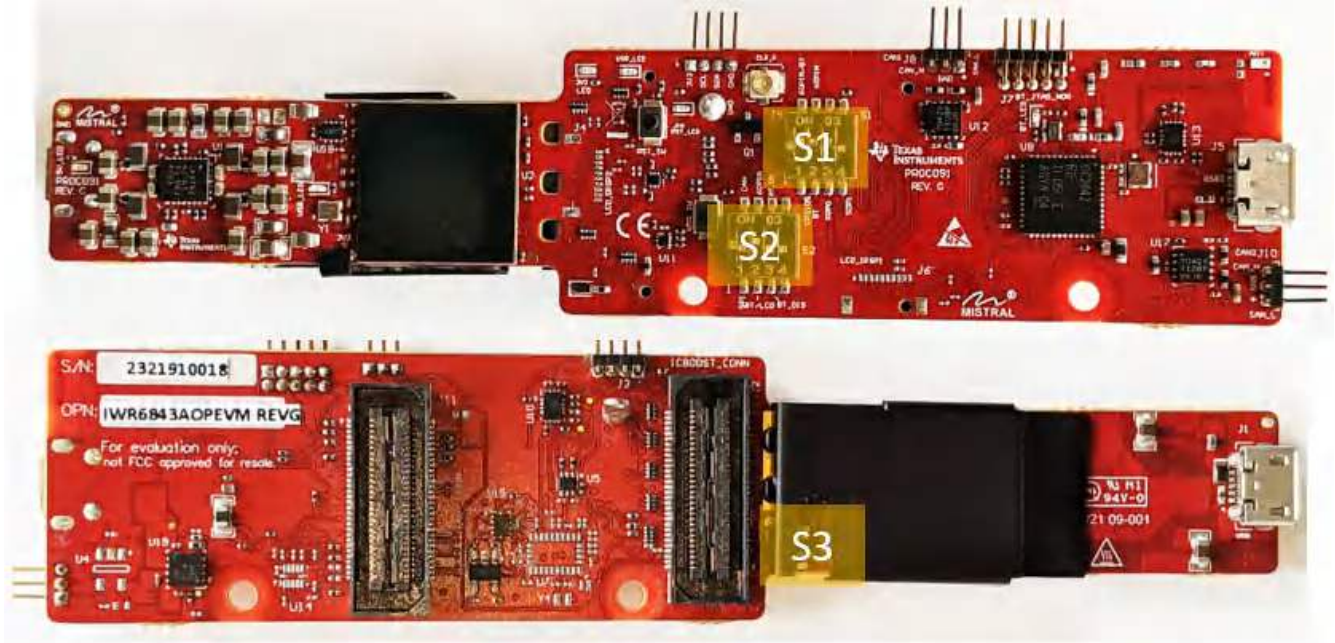

Figure 4-11. xWR6843AOPEVM Switches

Table 4-1. Switches

Reference Designator	Switch ON	Switch OFF
S1.1	UART routed to 60-pin connector / Bluetooth	UART routed to CP2105 UART
S1.2	UART routed to 60-pin connector	UART routed to Bluetooth
S1.3	SOP0 pulled down	SOP0 pulled up
S1.4	SOP1 pulled up	SOP1 pulled down
S2.1	SPI MISO/MOSI routed to CAN Transceiver	SPI MISO/MOSI routed to 60-pin connector / BT/ LCD
S2.2	SPI CS routed to 60-pin connector	SPI CS routed to BT/ LCD
S2.3	Bluetooth Enable	Bluetooth Disable
S2.4	Not Connected	Not Connected
S3	SOP2 Pulled up	SOP2 Pulled down
SW2	Reset switch	
SW3	User switch	

4.7 xWR6843AOPEVM Muxing Scheme

The xWR6843AOPEVM UART RX/TX can be routed to the Samtec 60-pin connector, USB to UART (CP2105), and bluetooth (BT) device (CC2640R2F), as detailed in [Table 4-2](#).

Table 4-2. Pin Mux Settings

Modes	S1.1	S1.2	S1.3	S1.4	S2.1	S2.2	S2.3	S2.4	S3
Modular (USB)CP2105, see Figure 7-8	OFF	NA	OFF	OFF	OFF	N/A	N/A	N/A	OFF (Functional AOP IC Mode) ON (Flashing AOP IC Mode)
Modular - (Bluetooth)CC2642R2F, see Figure 7-9	ON	OFF (Functional Bluetooth Mode) ON (Programming Bluetooth Mode)	OFF	OFF	OFF	OFF	OFF (Functional Bluetooth Mode) ON (Programming Bluetooth Mode)	N/A	OFF
MMWAVEICBOOST - Samtec 60 Pin Conn, see Figure 7-10	ON	ON	ON	OFF	OFF	ON	N/A	N/A	OFF

4.7.1 SOP Configuration

Table 4-3. SOP Configuration

	SOP0(S1.3)	SOP1(S1.4)	SOP2(S3)
Flashing	OFF	OFF	ON
Functional	OFF	OFF	OFF
MMWAVEICBOOST Mode (DCA1000, JTAG, and so forth)	ON	OFF	OFF

Note

SOP0 is pulled high when switch is on the OFF position and low when the switch is the ON position. SOP 1 and 2 are pulled low when the switch is OFF and high when the switch is ON.

In MMWAVEICBOOST mode, the xWR6843AOPEVM is mounted on the MMWAVEICBOOST and the SOP mode is set by the MMWAVEICBOOST.

4.8 Modular, DCA1000EVM and MMWAVEICBOOST Mode

The IWR6843AOP can be used in modular mode or mounted on the MMWAVEICBOOST for debugging.

4.8.1 Modular Mode

When used in Modular mode, the UART can either be routed to the CP2105 device, which displays the data on the mmWave visualizer, or to other devices connected to the USB interface. The UART data can also be routed to the CC2642R2F, which transmits data to a wireless device through Bluetooth. [Figure 4-12](#) shows the setup for CP2105. [Figure 4-13](#) shows the setup for CC2642R2F. ¹

¹ For higher power application ensure the USB J1 is connected before connecting USB J5.

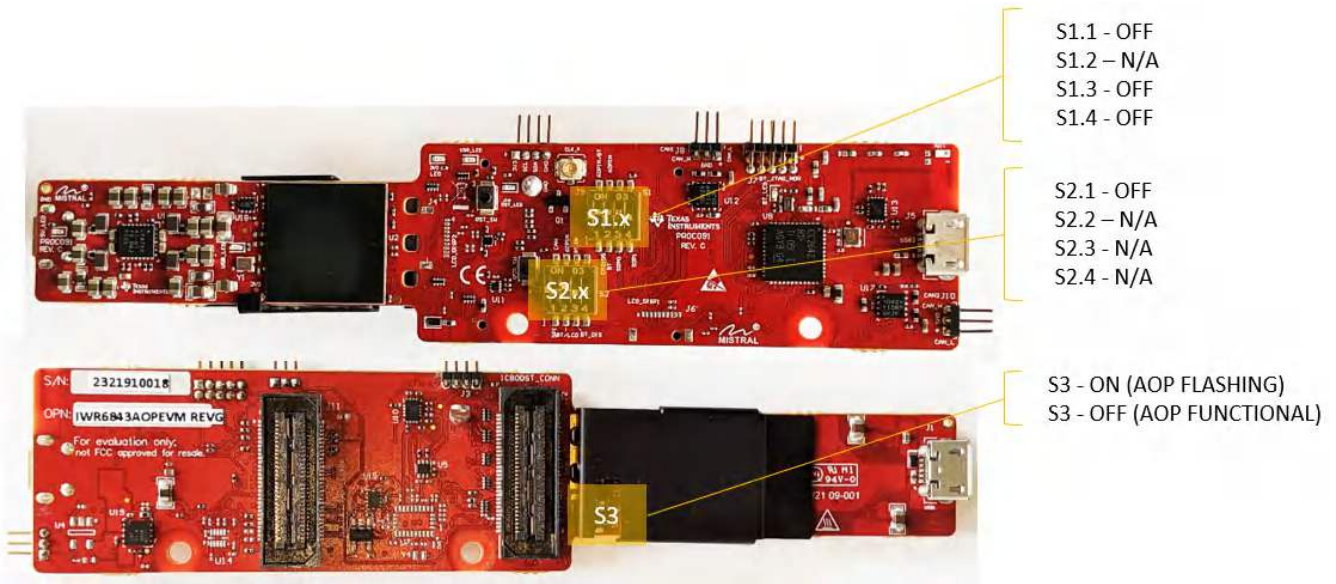

Figure 4-12. Switch Configuration for Modular (USB) Mode

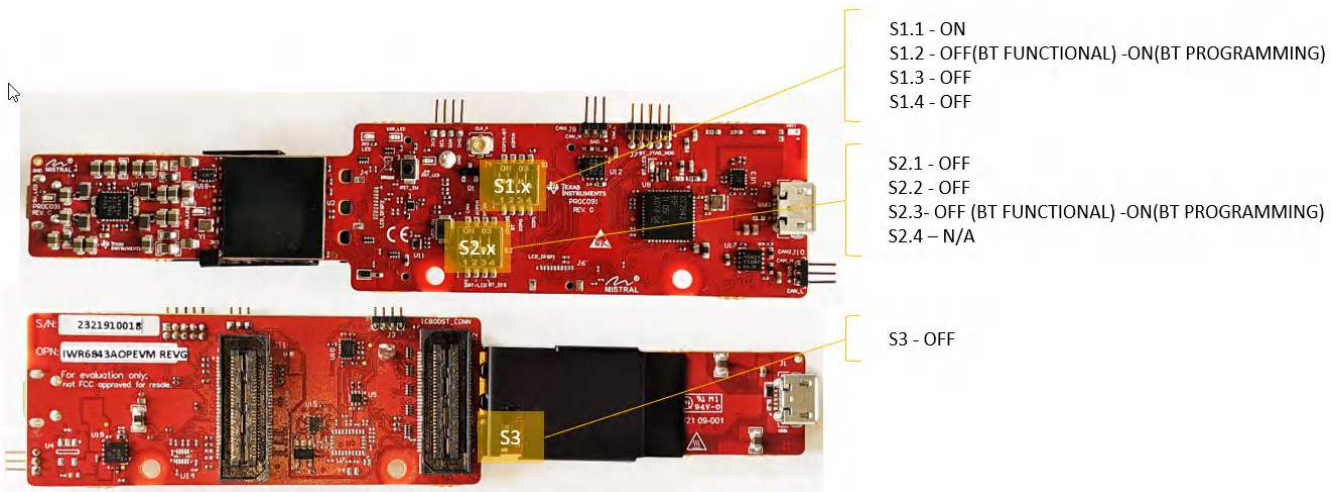

Figure 4-13. Switch Configuration for Modular (Bluetooth) Mode

4.8.2 DCA1000EVM Mode

In REV G, a second 60-pin connector (connector J11) is provided to allow for direct connection to DCA1000EVM. When in this mode, set the switch settings as shown in figure below

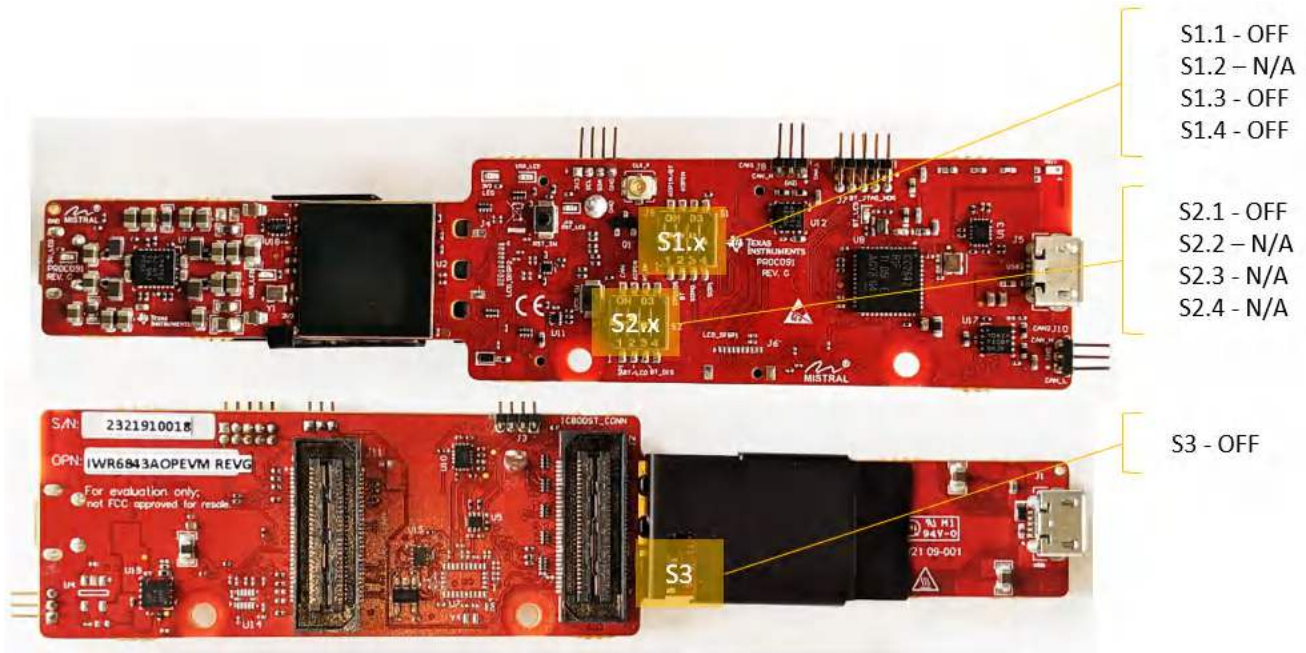

Figure 4-14. Switch Configuration for DCA1000EVM Mode

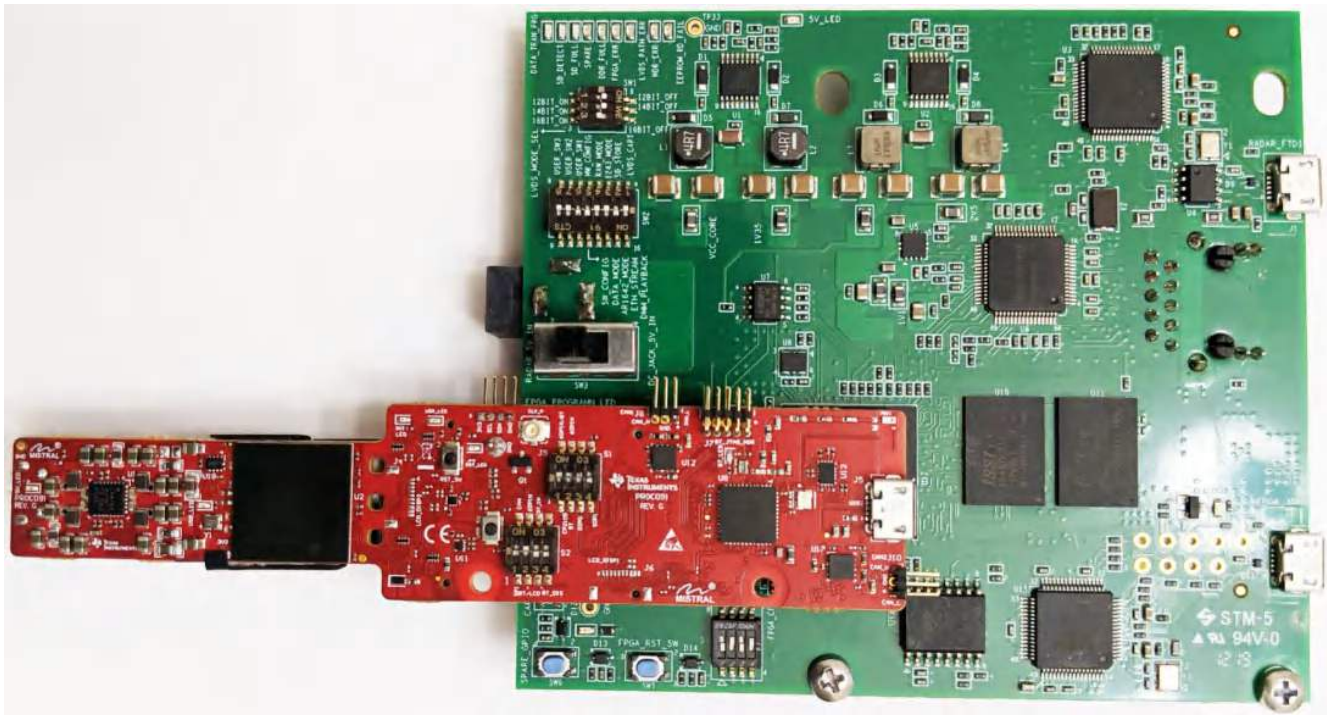

Figure 4-15. Setup with xWR6843AOPEVM and DCA1000EVM

4.8.3 MMWAVEICBOOST Mode

This mode enables access to debugging tools available on the MMWAVEICBOOST such as the JTAG, ADC capture, CAN, LaunchPad connector, and so forth.

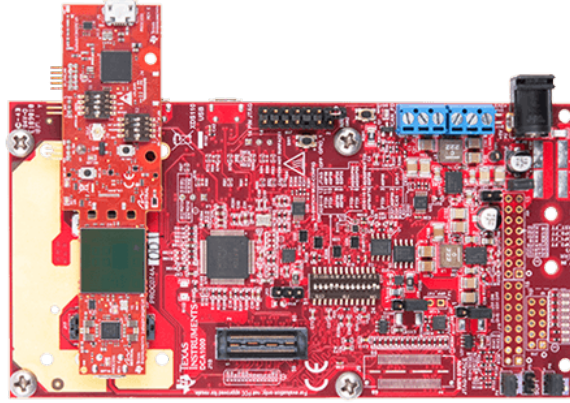

Figure 4-16. xWR6843AOPEVM Mounted on MMWAVEICBOOST

For mounted mode, the UART should be routed to the 60-pin connector. Set up the device as shown in [Figure 4-17](#). When mounted as shown, the SOP mode is overridden by the MMWAVEICBOOST SOP configuration.

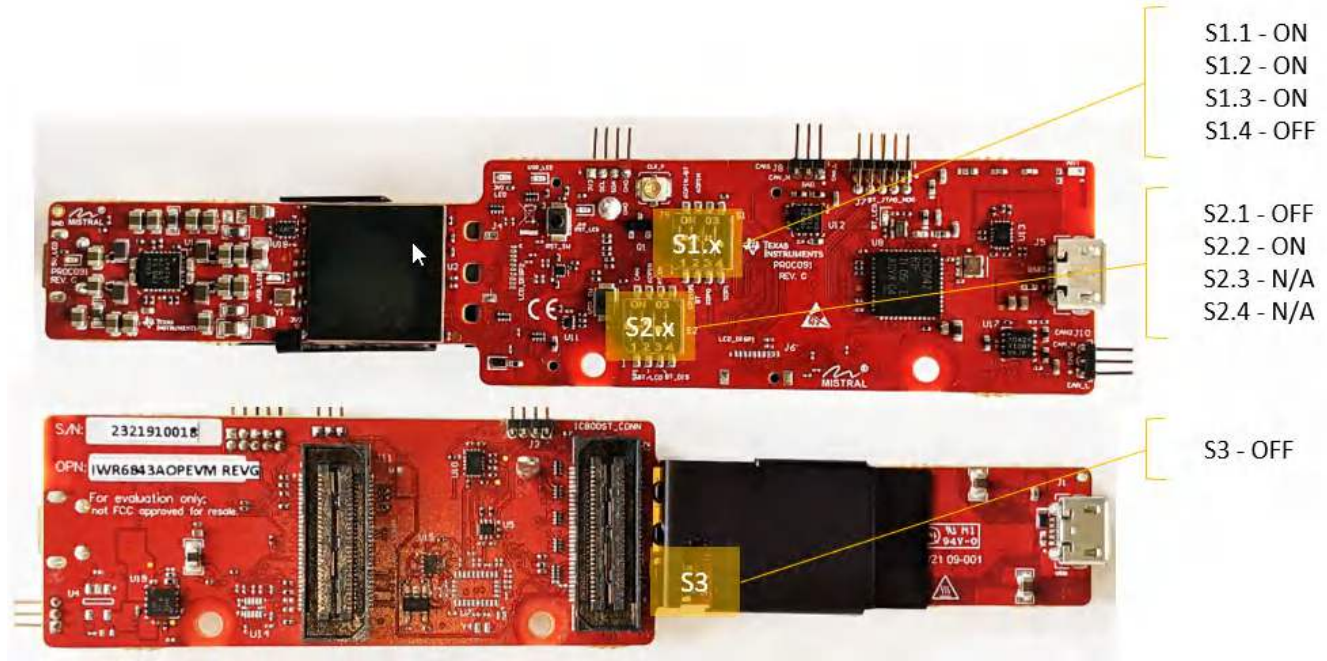

Figure 4-17. Switch Configuration for MMWAVEICBOOST Mode

4.9 Known Issues: Spurious Performance

A power vs frequency plot of the raw ADC data captured with DCA100EVM shows a spur near 4MHz that is 12dB above the ADC noise floor. This spur degrades the available spur-free dynamic range (SFDR) of the frontend receiver.

The spur is as a result of the switching of the power module device (LP87524) at 4MHz which couples via the power supplies of the IWR6843AOP device.

The power module device (LP87524) has a feature to enable spread spectrum which can be leveraged to reduce the level of the spur. More on spread spectrum can be found in section 7.3.1.4 of the [LP87524 data sheet](#). Enabling spread spectrum mode is recommended and it has the effect of reducing the spur level by 10dB, lowering the noise spectral density and shifting the spur frequency from 4MHz to 3.89MHz.

Spread spectrum mode can be enabled by writing the following to the I2C interface of the power module:

- Write 0x01 to register address 0x2B, I2C address = 0x60
- Write 0xD6 to register address 0x2C, I2C address = 0x60

For help enabling the spread spectrum mode, contact TI support through [E2E](#).

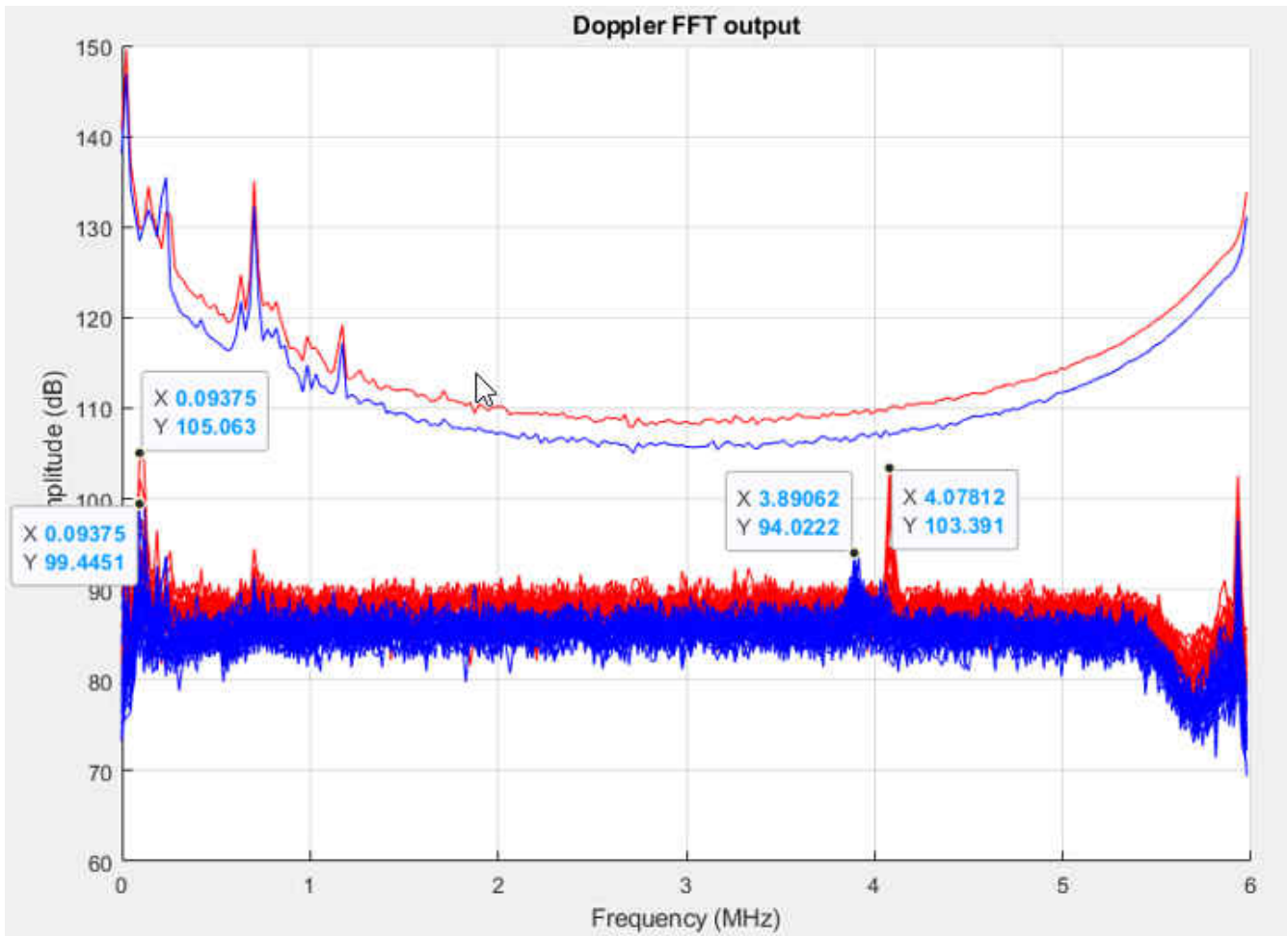

Figure 4-18. ADC spectrum with spread spectrum enabled (blue) vs disabled (red)

4.10 PC Connection

4.10.1 Installing the Drivers

The CP2105 drivers must be installed to access the UART port. Download and install the drivers [here](#).

When installed correctly, the COM port should be enumerated as shown in .

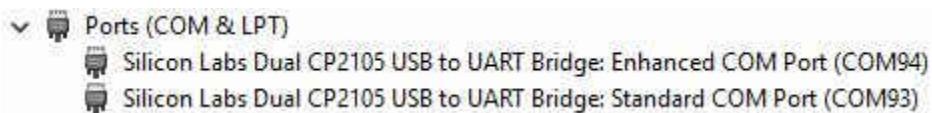

Figure 4-19. CP2105 COM Ports

The enhanced COM port is the application/user UART and the standard COM port is the data port.

4.10.2 Flashing the Board

1. Ensure the drivers have been successfully installed and COM ports enumerated.
2. Configure the SOP to flashing mode.
3. Run the UniFlash tool.
4. Press the reset switch to ensure that the board boots up in the right mode.
5. Enter the Enhanced COM Port in UniFlash interface.
6. Load image to serial flash.

4.11 REACH Compliance

In compliance with the Article 33 provision of the EU REACH regulation, this is to notify you that this EVM includes component(s) containing at least one substance of very high concern (SVHC) above 0.1%. The uses from Texas Instruments do not exceed 1 ton per year. The SVHC's are:

Table 4-4. REACH Information

Component Manufacturer	Component Type	Component Part Number	SVHC Substance	SVHC CAS (when available)
Bivar	LED	SM0402GC	1,3,5-tris(oxiranylmethyl)-1,3,5-triazine-2,4,6(1H,3H,5H)-trione	2451-62-9

4.12 Regulatory Statements with Respect to the xWR6843AOPEVM Rev G

FCC

1. FCC Interference Statement (Part 15.105 (a))

Note: This equipment has been tested and found to comply with the limits for a Class A digital device, pursuant to part 15 of the FCC Rules. These limits are designed to provide reasonable protection against harmful interference when the equipment is operated in a commercial environment. This equipment generates, uses, and can radiate radio frequency energy and, if not installed and used in accordance with the instruction manual, may cause harmful interference to radio communications. Operation of this equipment in a residential area is likely to cause harmful interference in which case the user will be required to correct the interference at his own expense.

2. FCC Part 15 Clause 15.21 [Do not Modify warning]:

“Changes or modifications not expressly approved by the party responsible for compliance could void the user's authority to operate the equipment”.

3. FCC Part 15.19(a) [interference compliance statement], unless the following statement is already provided on the device label:

“This device complies with part 15 of the FCC Rules. Operation is subject to the following two conditions: (1) This device may not cause harmful interference, and (2) this device must accept any interference received, including interference that may cause undesired operation.”

4. RF Exposure Guidance Statement (in English, for mobile equipment used a specified distance away from persons):

“In order to comply with FCC RF Exposure requirements, this device must be installed to provide at least 20 cm separation from the human body at all times.”

5. The xWR6843AIOEVM Rev G per 15.255 rules can only be used in fixed applications.

5 xWR6843AOPEVM Rev F



CAUTION HOT SURFACE
CONTACT MAY CAUSE BURN
DO NOT TOUCH

Note

RECOMMENDED DUTY CYCLE: The xWR6843AOPEVM operates at a maximum duty cycle of 50%: running at a higher duty cycle increases the risk of damaging the EVM by exceeding the maximum operating junction temperature (T_j) of 105°C.

Note

This chapter applies to the AWR6843AOPEVM and IWR6843AOPEVM

5.1 Hardware

The xWR6843AOPEVM includes four receivers and three transmitter wide field of antennas on the package of the device. The IWR6843AOP and AWR6843AOP operate at a 4-GHz bandwidth from 60 to 64 GHz, with a maximum output power of 10 dBm; the xWR6843AOPEVM has an antenna gain of ~5 dBi.

Note

The xWR6843AOPEVM has been tested in the 60 - 64GHz band across the temperature range of -20°C to 60°C.

Note

In accordance to the EN 62311 RF exposure test, a minimum separation distance of 20 centimeters should be maintained between the user and the EVM during operation.

Note

Refer to the [Thermal Design Guide for Antenna on Package mmWave Sensor](#) application note for details of thermal dissipation options for xWR6843 AOP devices, particularly for small form factor designs such as the mission side of the EVM.

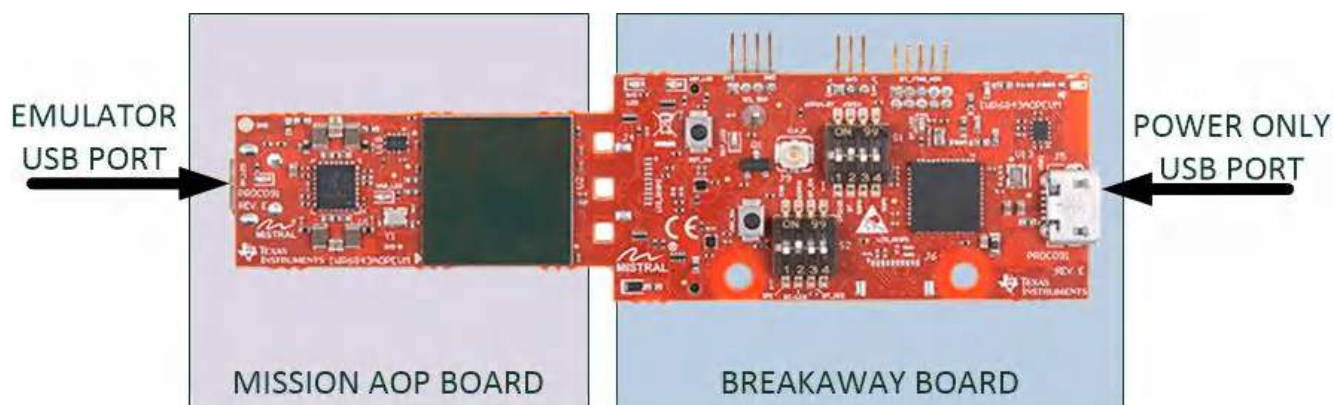

Figure 5-1. xWR6843AOPEVM Top View

When split, the following features are available:

- 60-GHz to 64-GHz mmWave sensing for form-factor deployment and testing
- Functional and flashing SOP Mode

- Emulator USB port for user UART and Data COM ports

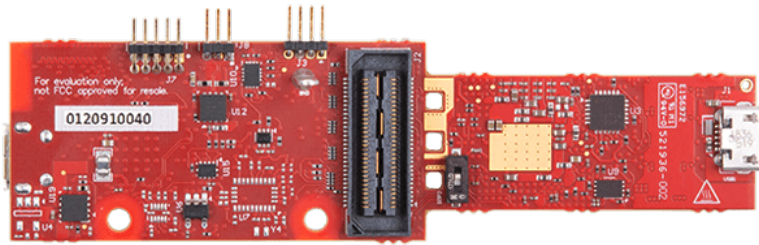

Figure 5-2. xWR6843AOPEVM Bottom View

CAUTION

There is a possibility of damage and loss of function to the mission board when it is split. When split, the board cannot be put back together and many features are lost; see the [Section 5.1](#) section for features available on the mission board. Raw data capture, JTAG debug and other features requiring the 60 pin SAMTEC connectors are permanently lost.

5.2 Block Diagram

[Figure 5-3](#) shows the functional block diagram. The mission board side contains the essential components for the TI radar system, PMIC, SFLASH, SOP configuration, Filter, TI mmWave Radar chip, and a USB to UART converter. The Breakaway board sections contain the 60-pin Samtec connector for interfacing with the MMWAVEICBOOST.

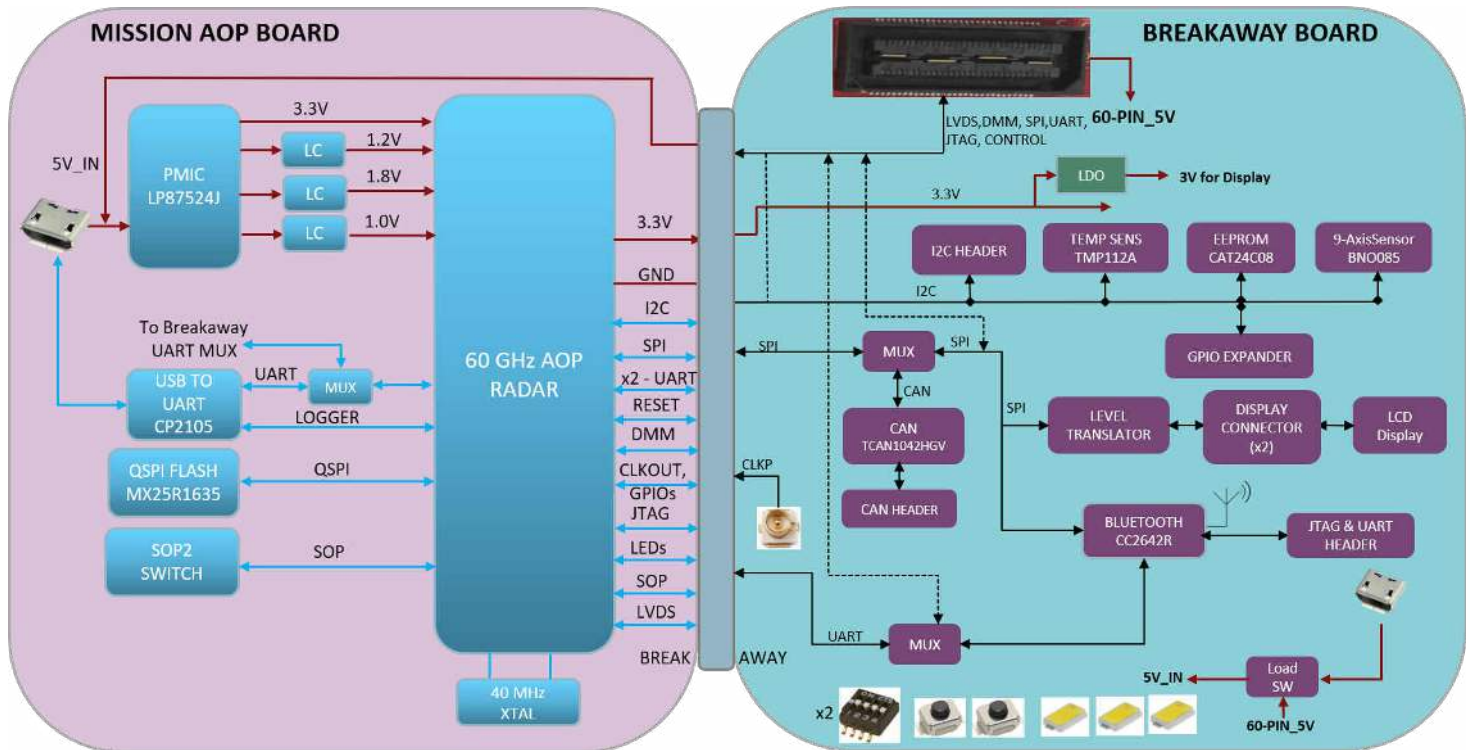

Figure 5-3. Block Diagram of the xWR6843AOPEVM

5.3 PCB Storage and Handling Recommendations

This EVM contains components that can potentially be damaged by electrostatic discharge. Always transport and store the EVM in its supplied ESD bag when not in use. Handle using an antistatic wristband. Operate on an antistatic work surface. For more information on proper handling, refer to [SSYA010A](#).

5.4 Heat Sink and Temperature

Users are strongly encouraged to use the xWR6843AOPEVM with the heat sink installed. Due to the smaller size of the xWR6843AOPEVM, it is likely to get warmer than other larger sized EVMs on the mmWave Radar portfolios care must be taken to ensure the junction temperature does not exceed 105°C. [Figure 5-4](#) shows measurement of junction temperature versus duty cycle taken with and without the heat sink. As seen in the plot, the EVM can safely operate up to 50% duty cycle with or without the heat sink. Although the heatsink is not absolutely required, usage of the heat sink provides protection against exceeding the junction temperature at higher duty cycles.

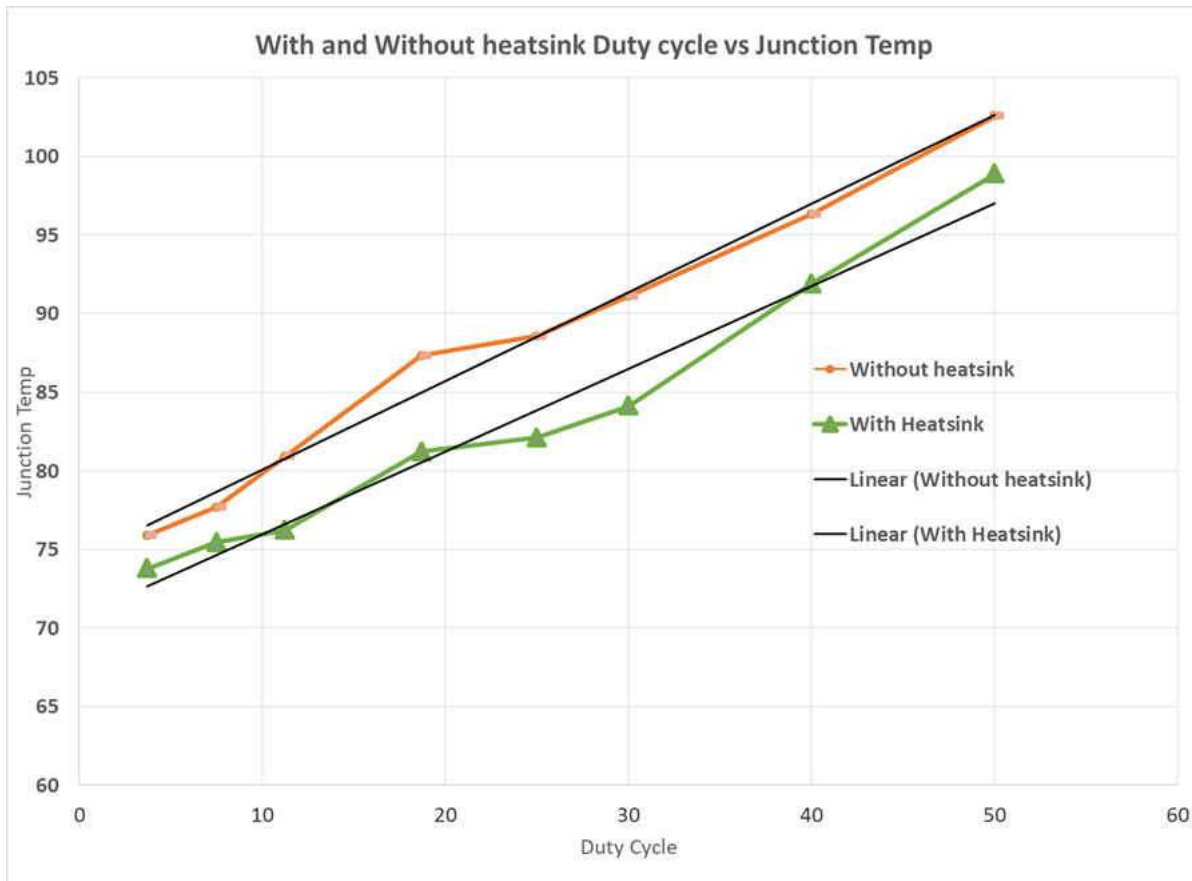

Figure 5-4. Duty Cycle versus Junction Temperature

When using the EVM for custom applications, the duty cycle can be adjusted as needed, the heat sink provided with the kit can be used, customers can also design their own heat sink using better heat dissipating materials or one with more surface area such as addition of fins. The CAD drawing for the heat sink is shown in [Figure 5-5](#)

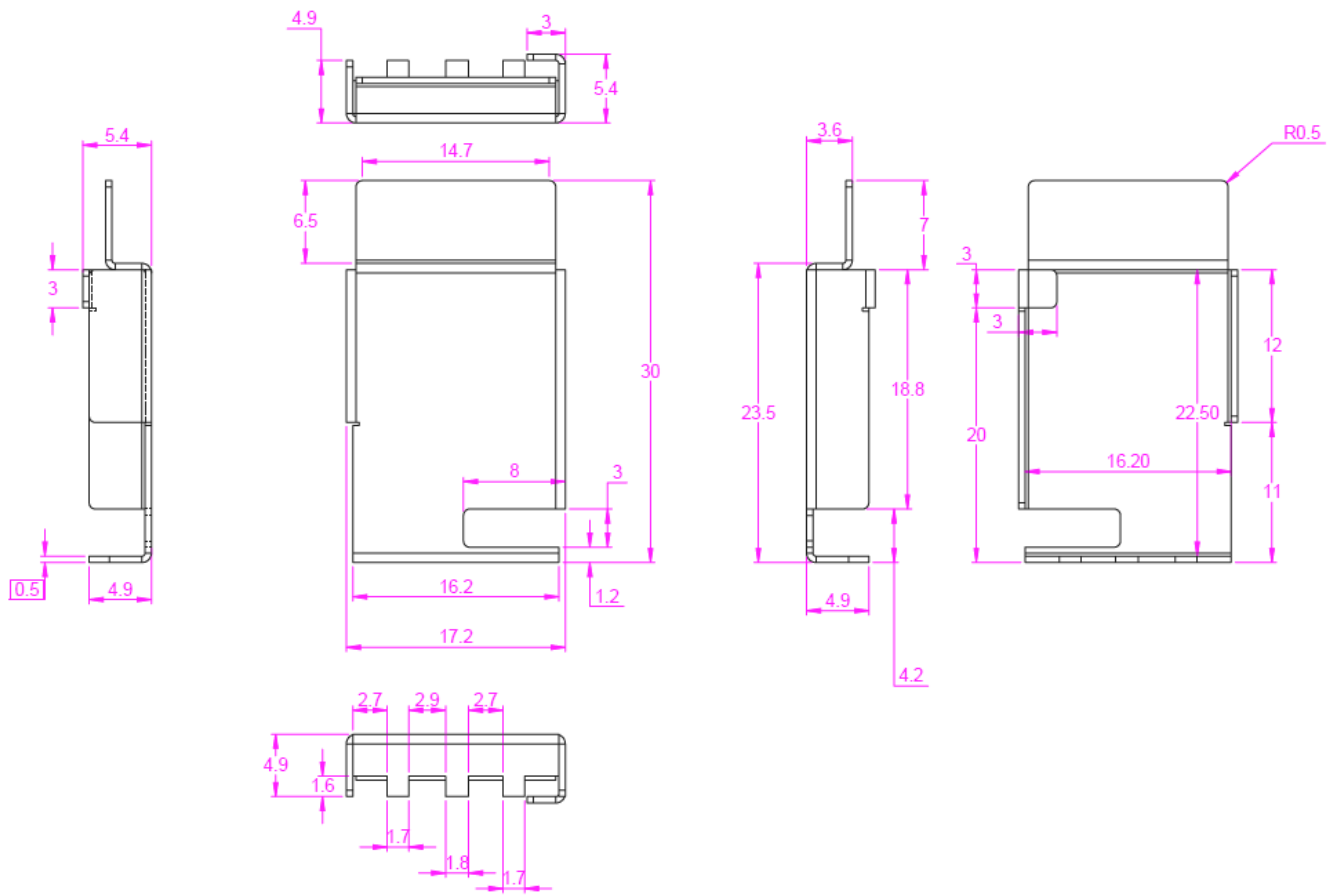

Figure 5-5. Heat sink CAD drawing

Application of the heat sink is shown in [Figure 5-6](#)

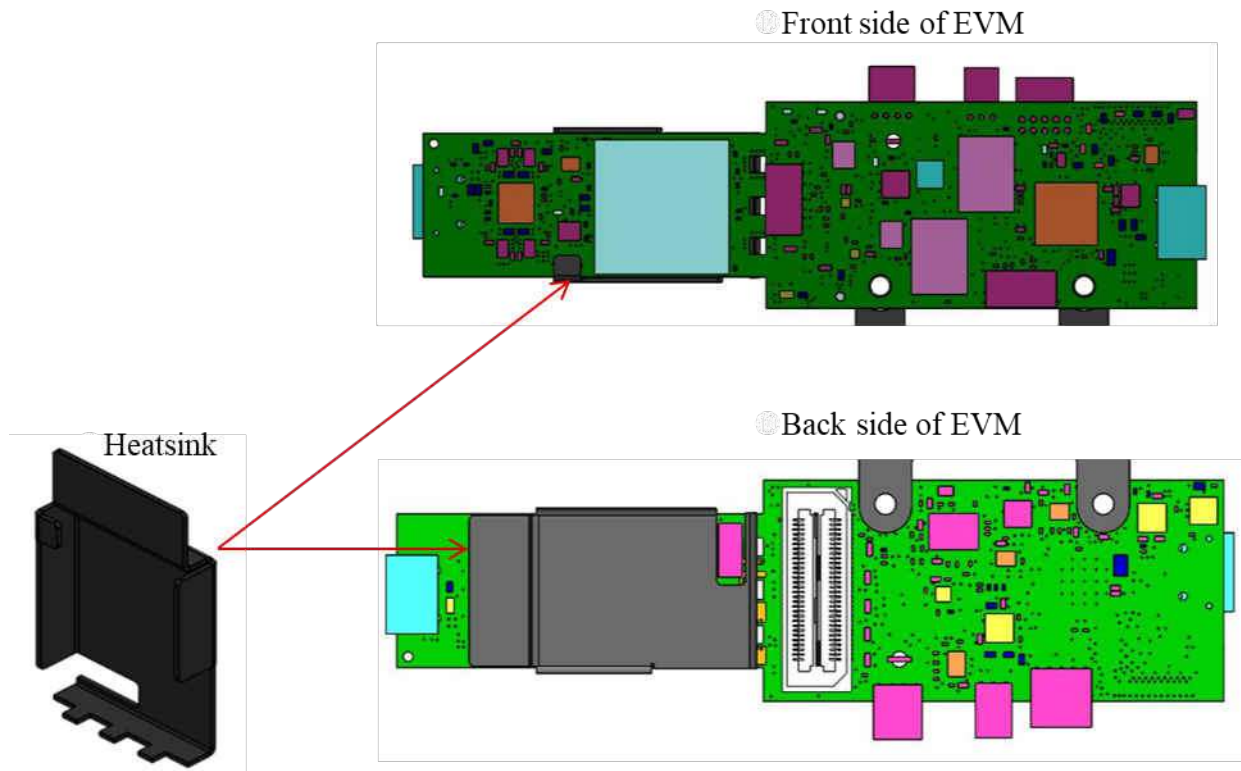

Figure 5-6. Heat sink placement

5.5 xWR6843AOPEVM Antenna

The xWR6843AOPEVM includes four receiver and three transmitter short range antennas on the package of the chip. Figure 5-7 shows the antenna on package.

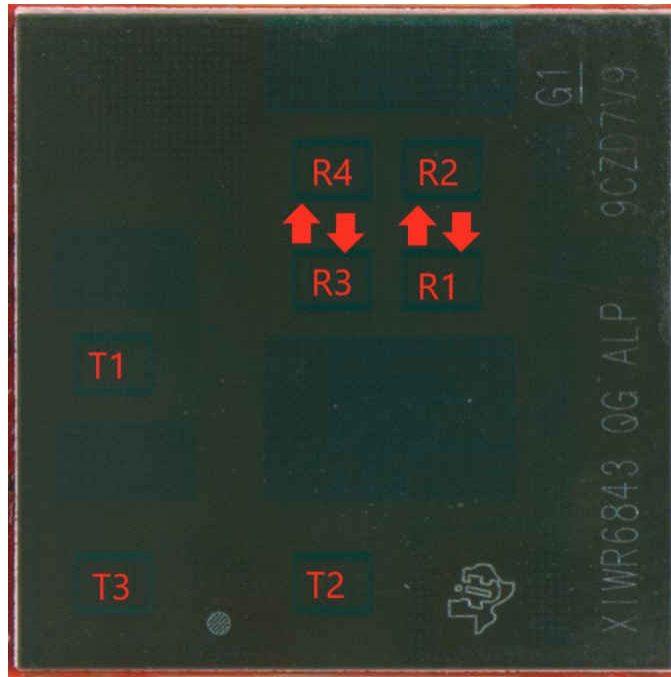

Figure 5-7. AOP Antennas

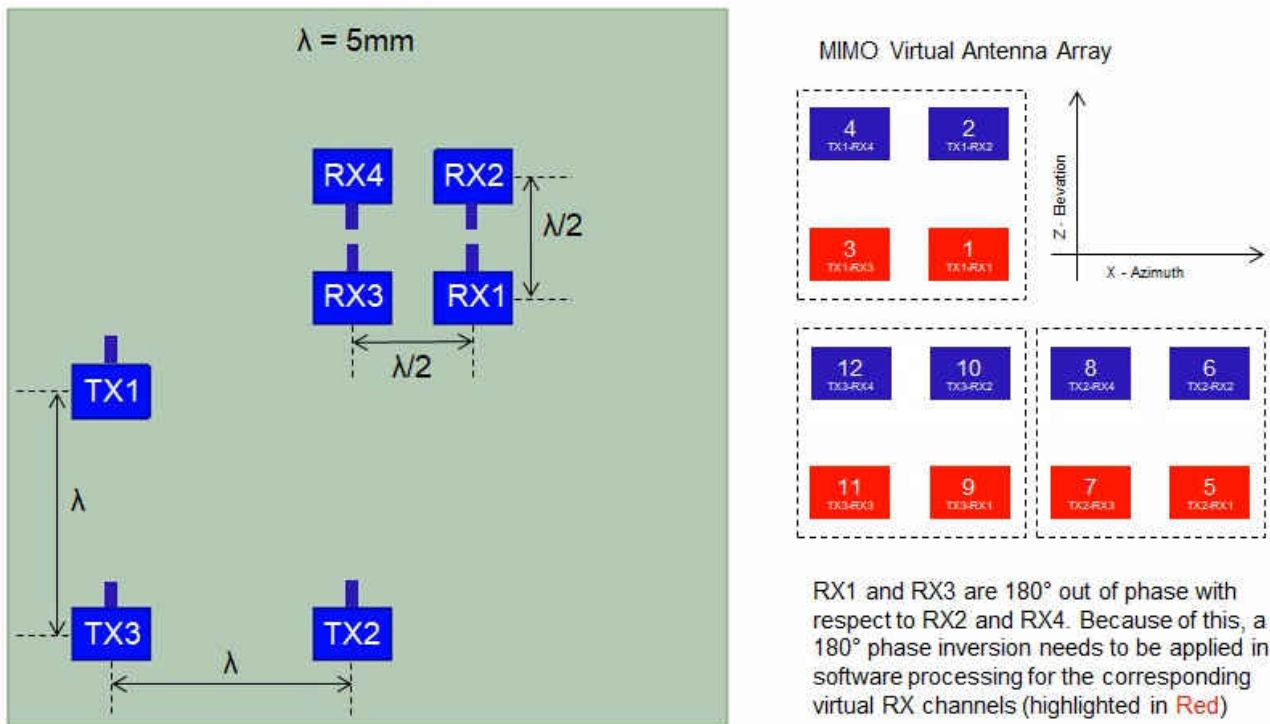
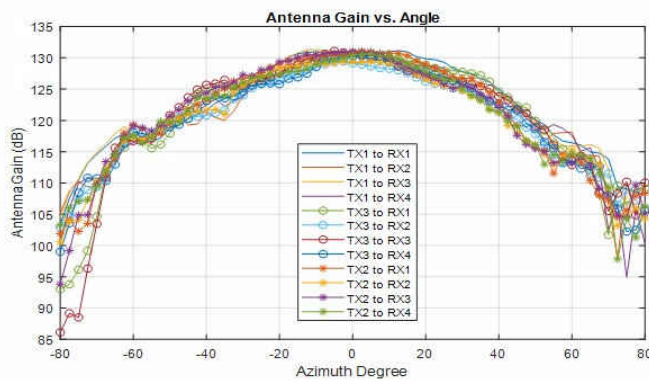
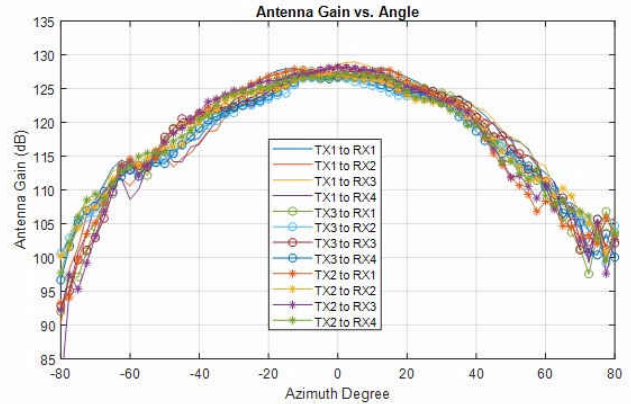

Figure 5-8. IWR6843AOP antenna placement MIMO array

Figure 5-9 shows the antenna radiation pattern with regard to azimuth. Figure 5-10 shows the antenna radiation pattern with regard to elevation for TX1, TX2, and TX3. Both show the radiation pattern for TX1, TX2, and TX3 and RX1, RX2, RX3, and RX4 together.



60 – 62 GHz



62 – 64 GHz

Figure 5-9. Measured Azimuthal Radiation Pattern for All Tx to Rx Pairs (All 12 Virtual Antenna Pairs Included)

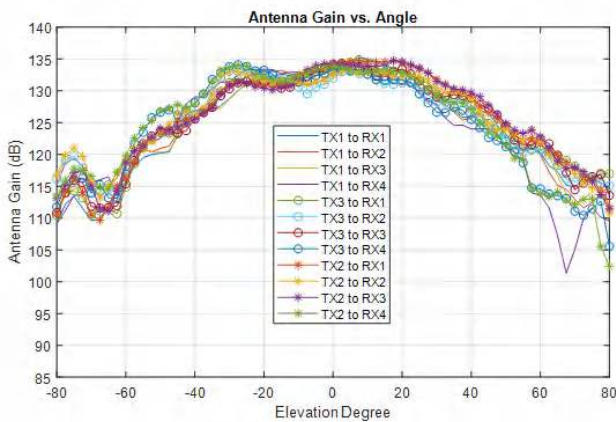

60 – 62 GHz

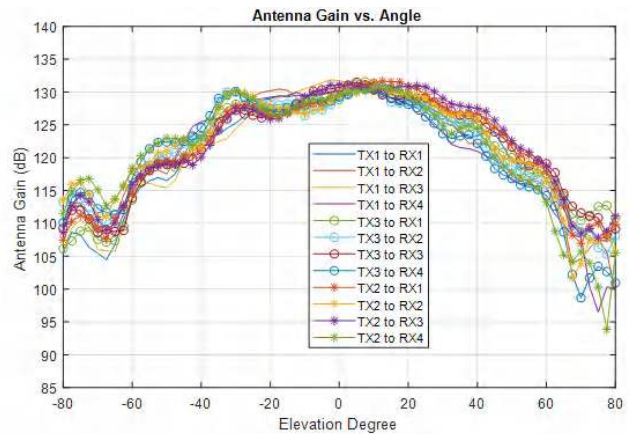

62 – 64GHz

Figure 5-10. Measured Elevation Radiation Pattern for All Tx to Rx Pairs (All 12 Virtual Antenna Pairs Included)

5.6 Switch Settings

Figure 5-11 shows the part designators and positions of the switches on the xWR6843AOPEVM.

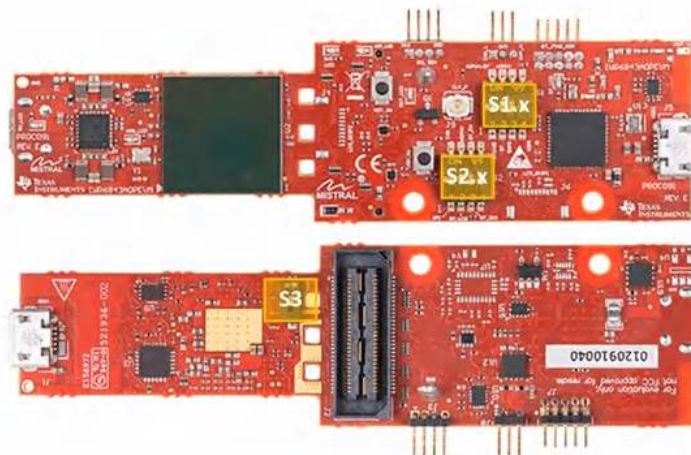

Figure 5-11. xWR6843AOPEVM Switches

Table 5-1. Switches

Reference Designator	Switch ON	Switch OFF
S1.1	UART routed to 60-pin connector / Bluetooth	UART routed to CP2105 UART
S1.2	UART routed to 60-pin connector	UART routed to Bluetooth
S1.3	SOP0 pulled down	SOP0 pulled up
S1.4	SOP1 pulled up	SOP1 pulled down
S2.1	SPI MISO/MOSI routed to CAN Transceiver	SPI MISO/MOSI routed to 60-pin connector / BT/ LCD
S2.2	SPI CS routed to 60-pin connector	SPI CS routed to BT/ LCD
S2.3	Bluetooth Enable	Bluetooth Disable
S2.4	Not Connected	Not Connected
S3	SOP2 Pulled up	SOP2 Pulled down
SW2	Reset switch	
SW3	User switch	

5.7 xWR6843AOPEVM Muxing Scheme

The xWR6843AOPEVM UART RX/TX can be routed to the Samtec 60-pin connector, USB to UART (SICP2105), and bluetooth (BT) device (CC2640R2F), as detailed in [Table 5-2](#)

Table 5-2. Pin Mux Settings

Modes	S1.1	S1.2	S1.3	S1.4	S2.1	S2.2	S2.3	S2.4	S3
Modular (USB)SICP2015, see Figure 7-8	OFF	NA	OFF	OFF	OFF	N/A	N/A	N/A	OFF (Functional AOP IC Mode) ON (Flashing AOP IC Mode)
Modular - (Bluetooth)CC2642R2F, see Figure 7-9	ON	OFF (Functional Bluetooth Mode) ON (Programming Bluetooth Mode)	OFF	OFF	OFF	OFF	OFF (Functional Bluetooth Mode) ON (Programming Bluetooth Mode)	N/A	OFF
MMWAVEICBOOST - Samtec 60 Pin Conn, see Figure 7-10	ON	ON	ON	OFF	OFF	ON	N/A	N/A	OFF

5.7.1 SOP Configuration

Table 5-3. SOP Configuration

	SOP0(S1.3)	SOP1(S1.4)	SOP2(S3)
Flashing	OFF	OFF	ON
Functional	OFF	OFF	OFF
MMWAVEICBOOST Mode (DCA1000, JTAG, and so forth)	ON	OFF	OFF

Note

SOP0 is pulled high when switch is on the OFF position and low when the switch is the ON position. SOP 1 and 2 are pulled low when the switch is OFF and high when the switch is ON.

In MMWAVEICBOOST mode, the xWR6843AOPEVM is mounted on the MMWAVEICBOOST and the SOP mode is set by the MMWAVEICBOOST.

5.8 Modular and MMWAVEICBOOST Mode

The IWR6843AOP can be used in modular mode or mounted on the MMWAVEICBOOST for debugging.

5.8.1 Modular Mode

When used in Modular mode, the UART can either be routed to the SICP2015, which displays the data on the mmWave visualizer, or to other devices connected to the USB interface. The UART data can also be routed to the CC2642R2F, which transmits data to a wireless device through Bluetooth. [Figure 5-12](#) shows the setup for SICP2015. [Figure 5-13](#) shows the setup for CC2642R2F. ²

² For higher power application ensure the USB J1 is connected before connecting USB J5.

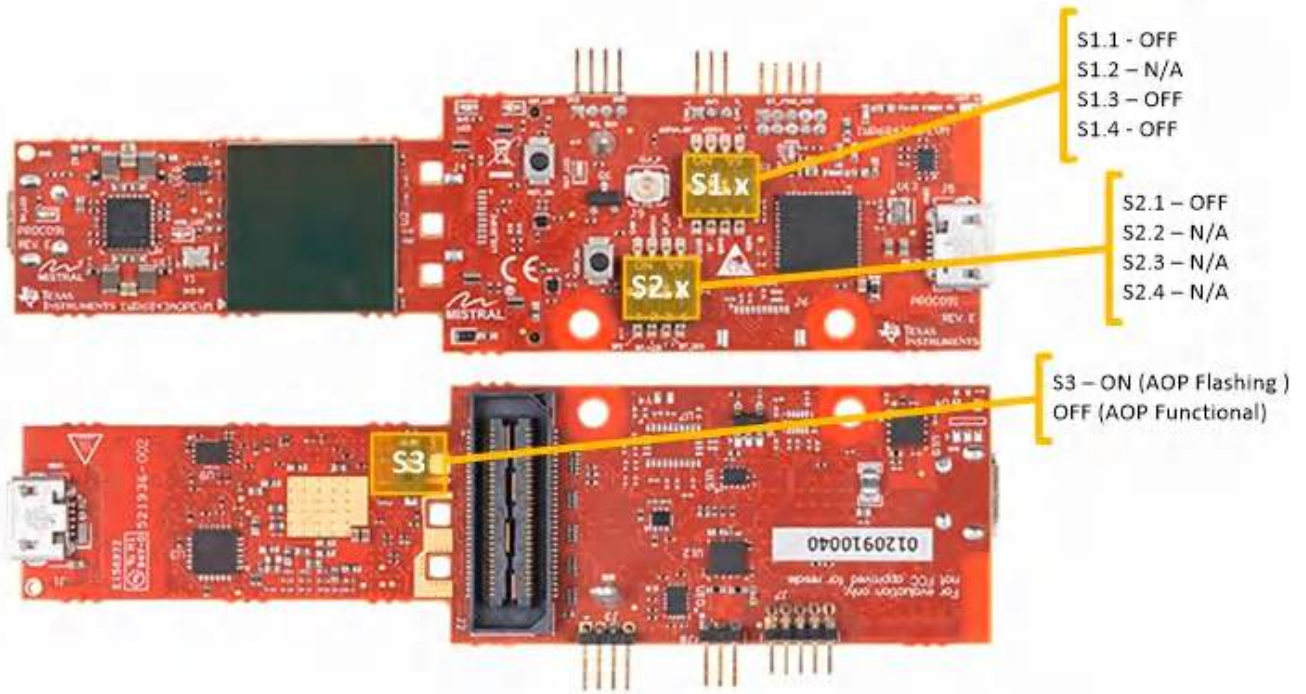

Figure 5-12. Switch Configuration for Modular Mode

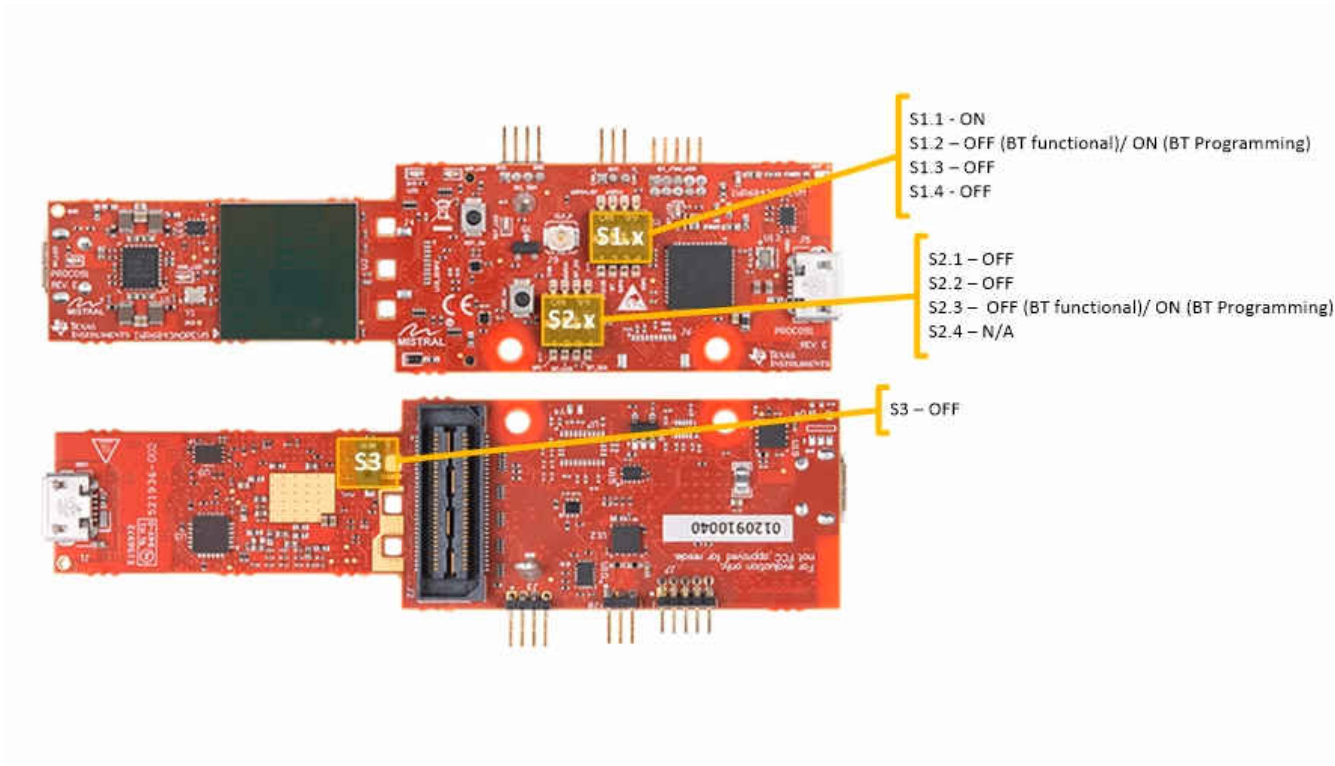

Figure 5-13. Switch Configuration for Bluetooth Mode

5.8.2 MMWAVEICBOOST Mode

This mode enables access to debugging tools available on the MMWAVEICBOOST such as the JTAG, ADC capture, CAN, LaunchPad connector, and so forth.

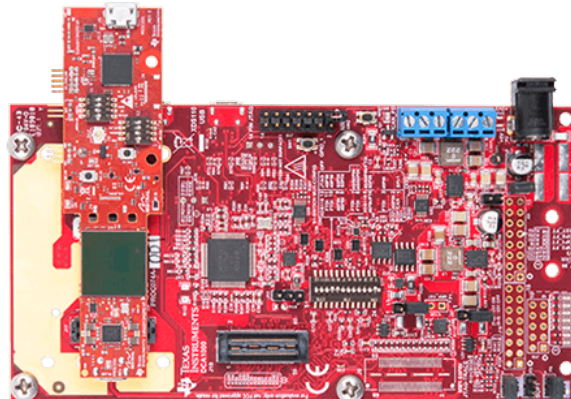

Figure 5-14. xWR6843AOPEVM Mounted on MMWAVEICBOOST

For mounted mode, the UART should be routed to the 60-pin connector. Set up the device as shown in [Figure 5-15](#). When mounted as shown, the SOP mode is overridden by the MMWAVEICBOOST SOP configuration.

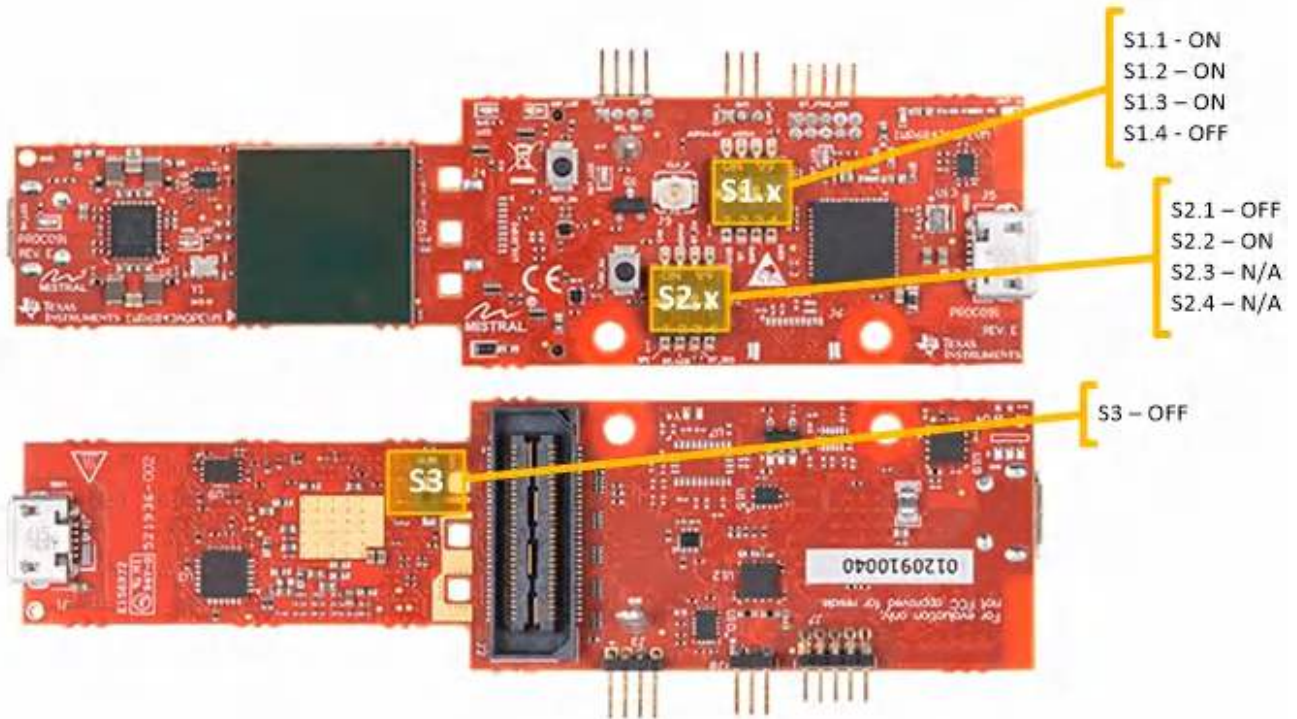

Figure 5-15. Switch Configuration for MMWAVEICBOOST Mode

5.9 PC Connection

5.9.1 Installing the Drivers

The SICP2105 drivers must be installed to access the UART port. Download and install the drivers [here](#).

When installed correctly, the COM port should be enumerated as shown in .

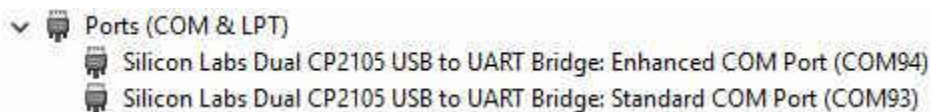

Figure 5-16. SICP2105 COM Ports

The enhanced COM port is the application/user UART and the standard COM port is the data port.

5.9.2 Flashing the Board

1. Ensure the drivers have been successfully installed and COM ports enumerated.
2. Configure the SOP to flashing mode.
3. Run the UniFlash tool.
4. Press the reset switch to ensure that the board boots up in the right mode.
5. Enter the Enhanced COM Port in UniFlash interface.
6. Load image to serial flash.

5.9.3 DCA1000

For data capture using the DCA1000, set up the board to MMWAVEICBOOST mode, having the SOP and UART muxed set correctly. Continue as you would with the IWR6843ISK. For more information, see [Section 2.5.3](#).

5.10 REACH Compliance

In compliance with the Article 33 provision of the EU REACH regulation, this is to notify you that this EVM includes component(s) containing at least one substance of very high concern (SVHC) above 0.1%. The uses from Texas Instruments do not exceed 1 ton per year. The SVHC's are:

Table 5-4. REACH Information

Component Manufacturer	Component Type	Component Part Number	SVHC Substance	SVHC CAS (when available)
Bivar	LED	SM0402GC	1,3,5-tris(oxiranylmethyl)-1,3,5-triazine-2,4,6(1H,3H,5H)-trione	2451-62-9

6 IWR6843ISK / IWR6843ISK-ODS (deprecated)

Figure 6-1 and Figure 6-2 shows the front and rear view of IWR6843ISK EVM, respectively. This EVM includes onboard etched long range antennas for the four receivers and three transmitters. The IWR6843 operates at a 4-GHz bandwidth from 60 to 64 GHz, with a maximum output power of 10 dBm; the IWR6843ISK has an antenna gain of ~7 dBi and the IWR6843ISK-ODS has an antenna gain of ~5 dBi.

6.1 Hardware



CAUTION HOT SURFACE
 CONTACT MAY CAUSE BURN
 DO NOT TOUCH

6.1.1 IWR6843ISK EVM

Note

The IWR6843ISK has been tested in the 60-64GHz band across the temperature range of -20°C to 60°C. The device is intended for use within the aforementioned limits.

Note

In accordance to the EN 62311 RF exposure test, a minimum separation distance of 20 centimeters should be maintained between the user and the EVM during operation.

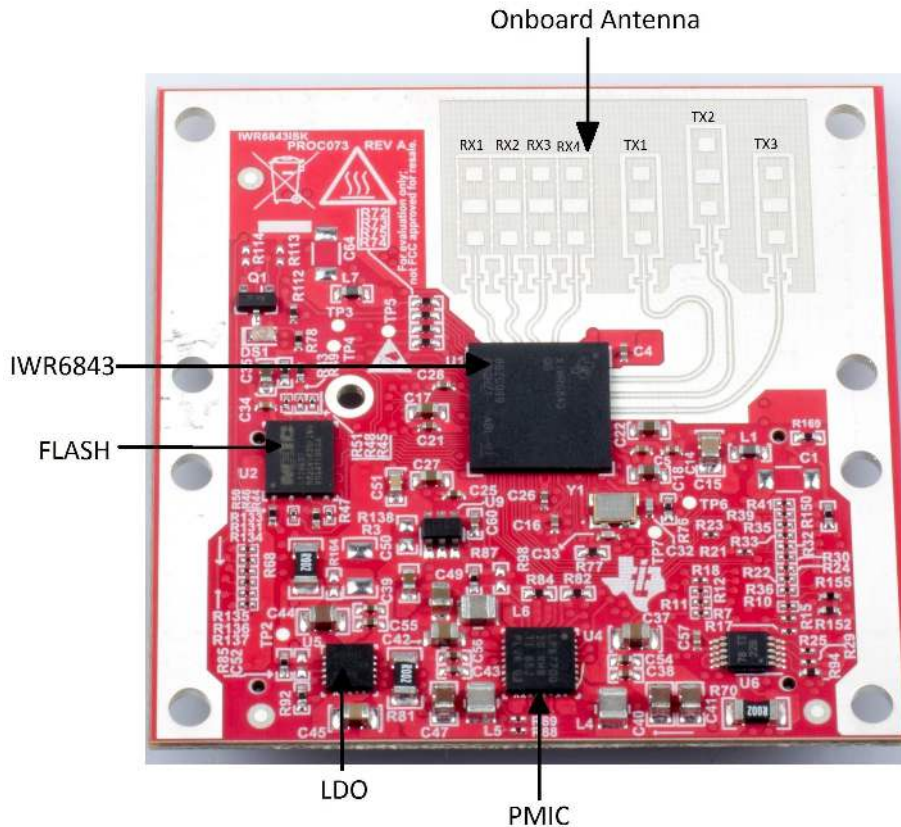

Figure 6-1. IWR6843ISK Front View

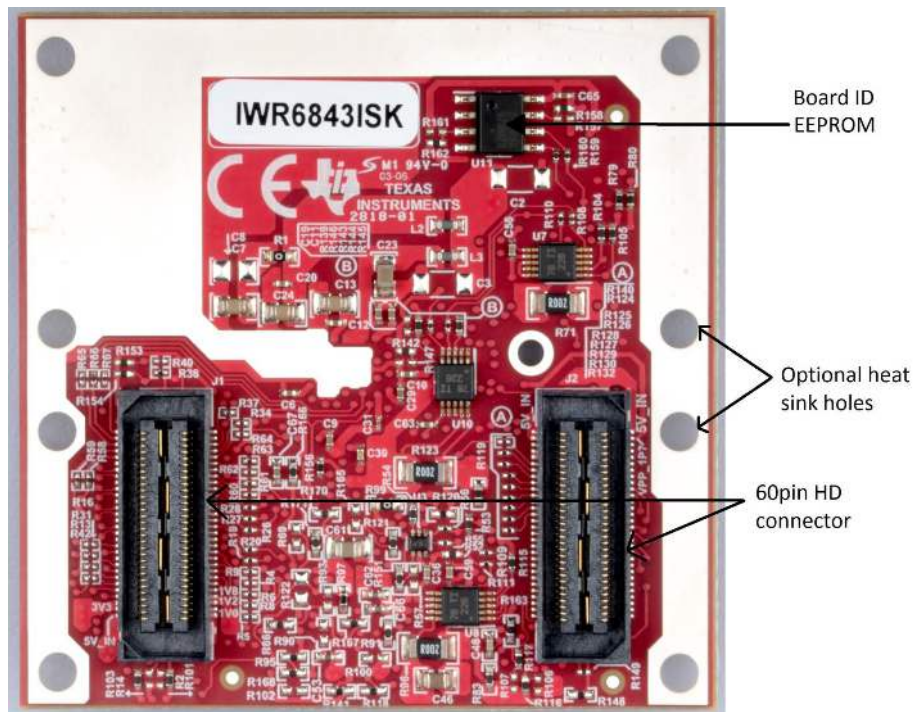

Figure 6-2. IWR6843ISK Rear View

6.1.2 IWR6843ISK-ODS EVM

The IWR6843ISK-ODS includes onboard-etched short range wide field of view antennas for the four receivers and three transmitters. [Figure 6-3](#) shows the PCB antennas.

Note

The IWR6843ISK-ODS has been tested in the 60-64GHz band across the temperature range of -20°C to 60°C.

Note

In accordance to the EN 62311 RF exposure test, a minimum separation distance of 20 centimeters should be maintained between the user and the EVM during operation.

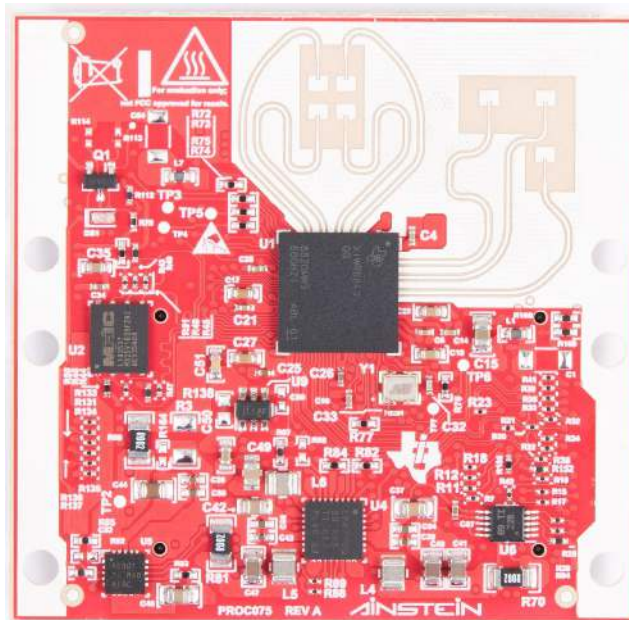

Figure 6-3. PCB Antenna – Top



Figure 6-4. PCB Antenna – Bottom

6.2 IWR6843ISK/IWR6843ISK-ODS Block Diagram

Figure 6-5 shows the functional block diagram.

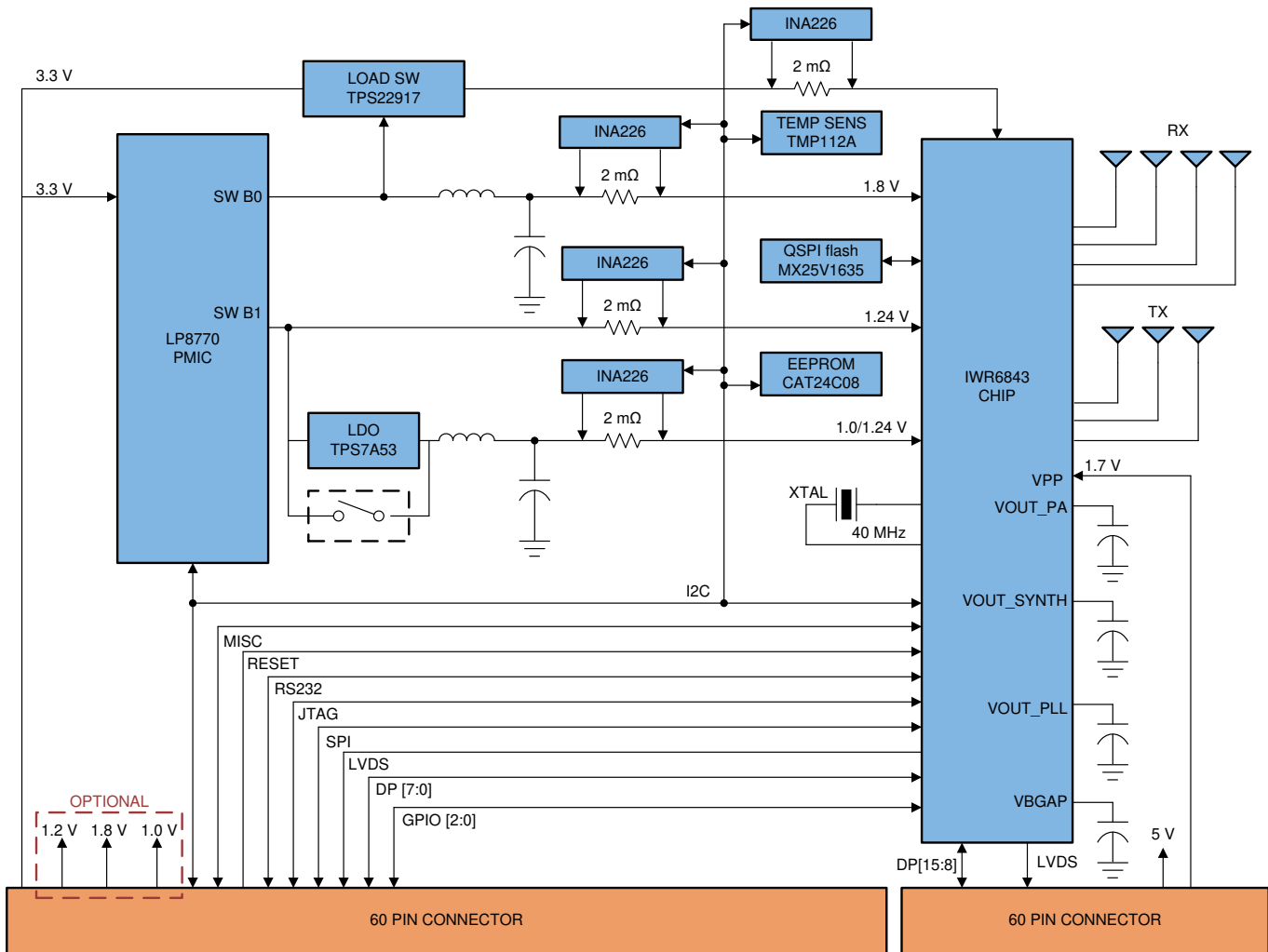

Figure 6-5. Block Diagram of IWR6843ISK/IWR6843ISK-ODS

6.3 PCB Storage and Handling Recommendations

The immersion silver finish of the PCB provides a better high-frequency performance, but is also prone to oxidation in open environments. This oxidation causes the surface around the antenna region to blacken.

To avoid oxidation, the PCB should be stored in an ESD cover and kept at a controlled room temperature with low humidity conditions. All ESD precautions must be taken while using and handling the EVM.

6.4 Power Connections

The Industrial starter kit is powered by the 3.3 V from the 60-pin HD connectors. When power is supplied, an on-board PMIC and LDO generate the voltages. The PGOOD LED glows to indicate all voltage rails are in limits.

Note

After the 3.3-V supply is provided to the EVM, TI recommends toggling the NRST signal once to ensure a reliable boot-up state; this signal is accessible on the 60-pin HD connector.

6.5 Miscellaneous and LEDs

6.5.1 List of LEDs

Table 6-1 shows the list of LEDs.

Table 6-1. List of LEDs

Reference Designator	Color	Usage	Comments	Image
DS1	Yellow	Power Good	This LED is used to indicate the PGOOD. If this LED is glowing means that all voltage rails are in limits.	 <p>Figure 6-6. PGood LED</p>

6.5.2 I2C Connections

The board features an EEPROM, current sensor, and temperature sensor for measuring on-board temperature. These are connected to the I2C bus and can be isolated using the zero Ω provided on the hardware.

6.5.2.1 EEPROM

The board features an EEPROM for storing the board specific IDs (for the identification of the starter kit connected to the MMWAVEICBOOST).

6.5.2.2 Default I2C Address

Table 6-2 provides the list of I2C devices and its address.

Table 6-2. IWR6843ISK I2C Devices and Address

Sensor Type	Reference Designator	Part Number	Slave Address
Temperature Sensor	U3	TMP112AQDRLRQ1	100 1011
EEPROM	U11	CAT24C08WI-GT3	101 00XX ⁽¹⁾
Current sensor1	U6	INA226AIDGST	100 0000
Current sensor2	U7	INA226AIDGST	100 0101
Current sensor3	U8	INA226AIDGST	100 0001
Current sensor4	U10	INA226AIDGST	100 0100
PMIC	U4	LP87702DRHBRQ1	110 0000

(1) XX means 00,01,10,11

6.6 IWR6843ISK Antenna

The IWR6843ISK includes onboard-etched long range antennas for the four receivers and three transmitters.

Figure 6-7 shows the PCB antennas.

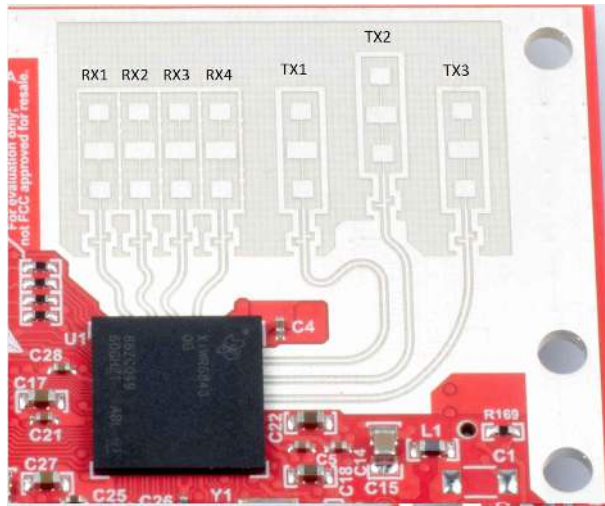

Figure 6-7. PCB Antennas

Figure 6-8 through Figure 6-10 shows the antenna radiation pattern with regard to azimuth. Figure 6-11 through Figure 6-13 show the antenna radiation pattern with regard to elevation for TX1, TX2, and TX3.

All of the measurements were done with a Tx and Rx combination together. Thus, for the -6dB beam width, you must see a -12db (Tx (-6dB) + Rx(-6dB)) number.

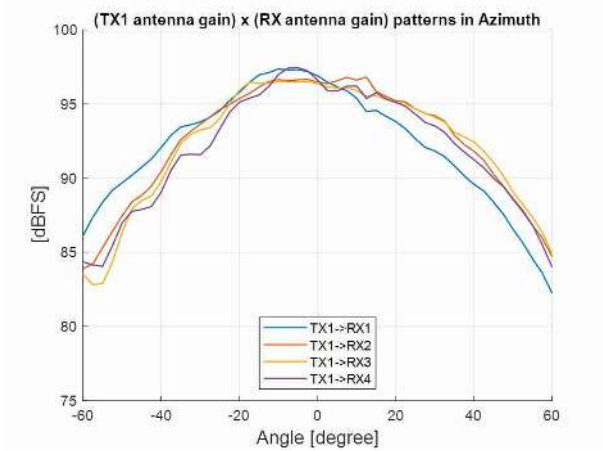

Figure 6-8. TX1 Antenna Radiation Pattern in Azimuth

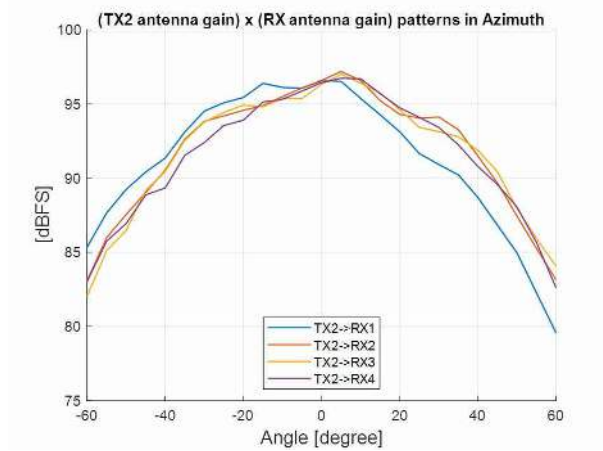

Figure 6-9. TX2 Antenna Radiation Pattern in Azimuth

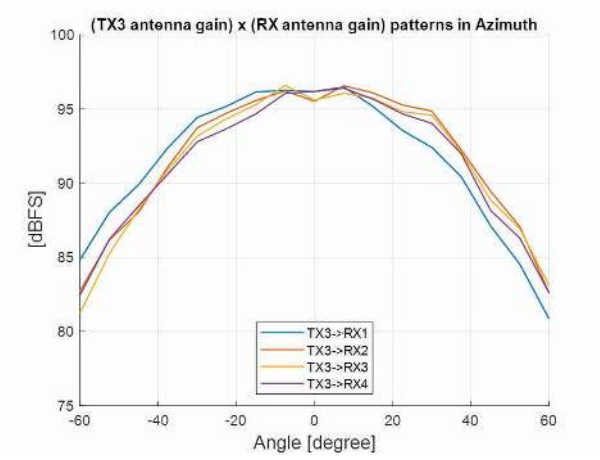

Figure 6-10. TX3 Antenna Radiation Pattern in Azimuth

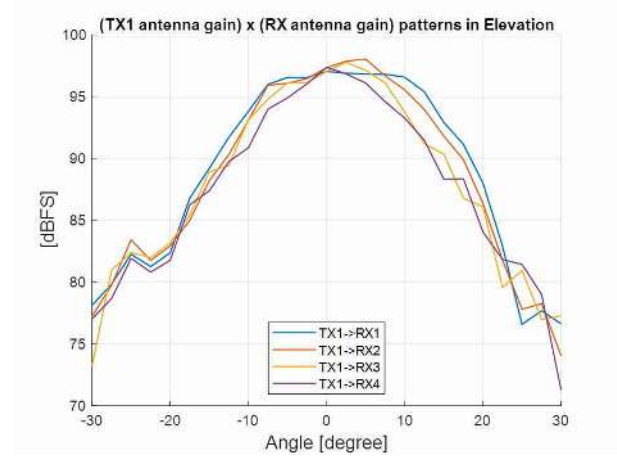

Figure 6-11. TX1 Antenna Radiation Pattern in Elevation

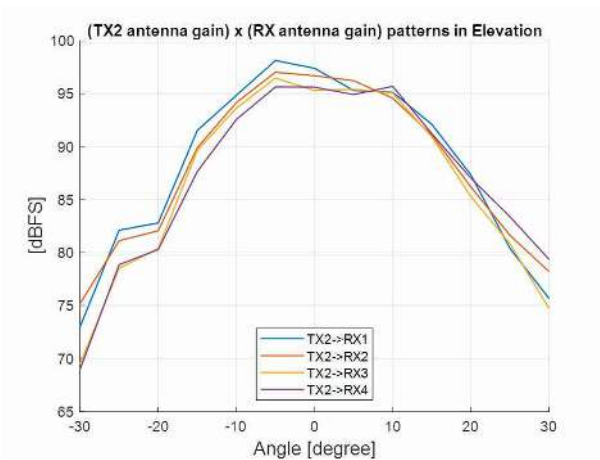

Figure 6-12. TX2 Antenna Radiation Pattern in Elevation

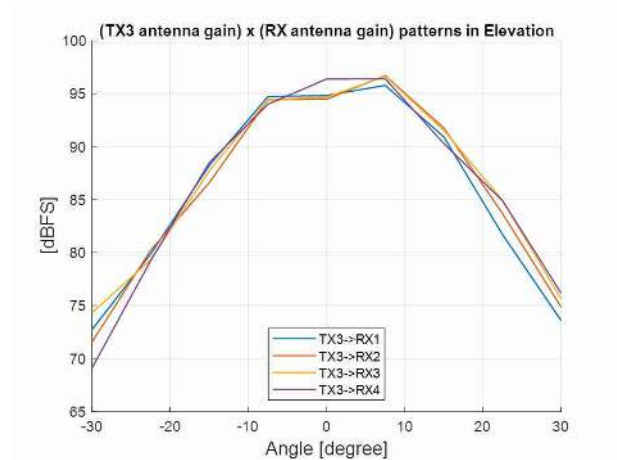

Figure 6-13. TX3 Antenna Radiation Pattern in Elevation

6.7 IWR6843ISK-ODS Antenna

The IWR6843ISK-ODS includes on-board-etched short range antennas (approximately 12-15 meters for people detection) for the four receivers and three transmitters. Figure 6-14 shows the PCB antennas arrangement. This provides equal angular resolution both in Azimuth and Elevation directions with the help of 4×3 virtual antennas positions.

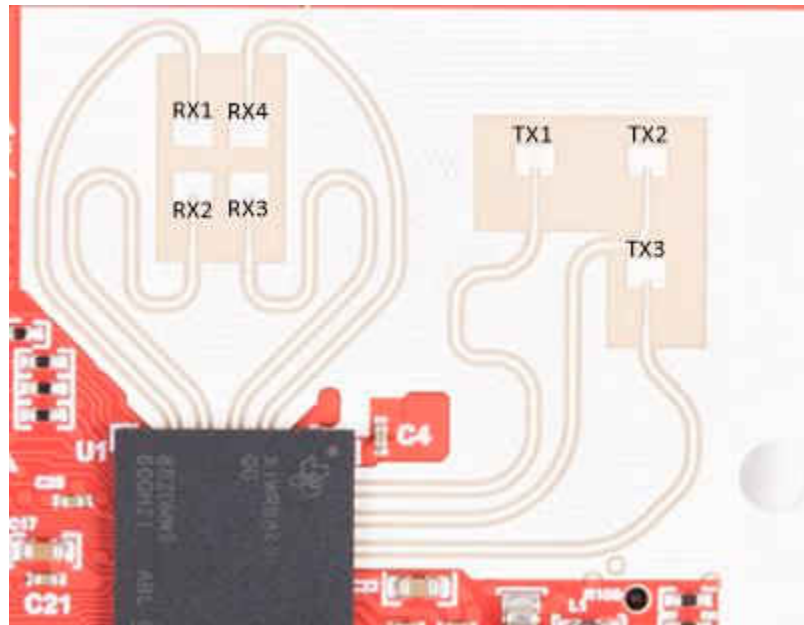

Figure 6-14. IWR6843ISK-ODS PCB Antenna

Figure 6-15 shows combined Antenna Radiation pattern in the Azimuth plane for all the transmitter and receiver pairs together (TX[1-3]-RX[1-4]).

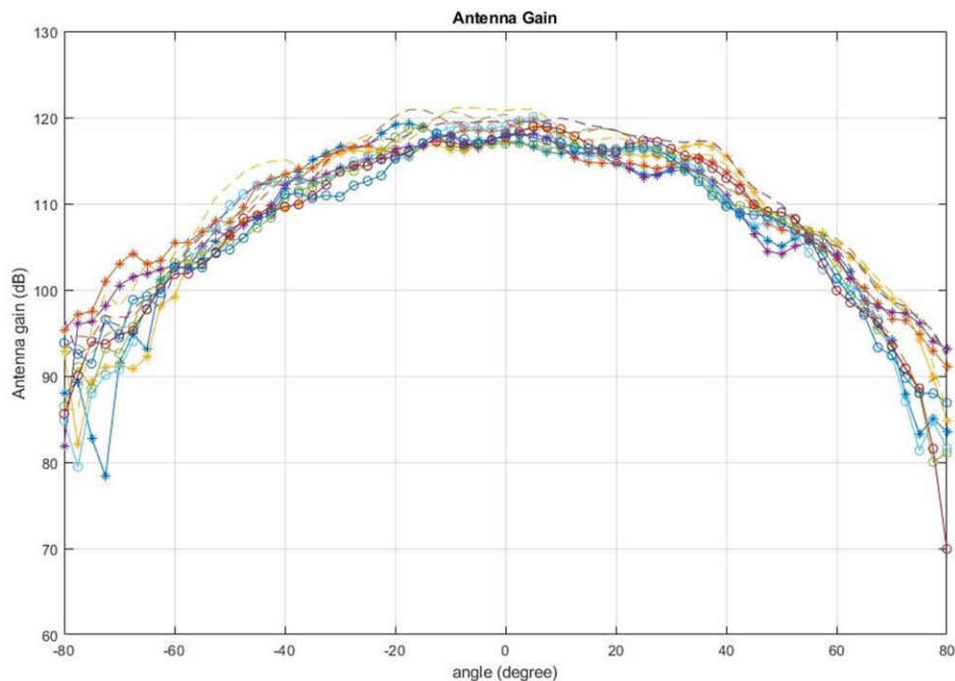

Figure 6-15. Measured Azimuthal Radiation Pattern for All Tx to Rx Pairs (All 12 Virtual Antenna Pairs Included)

Figure 6-16 shows the combined Antenna Radiation pattern in the Elevation plane for all the transmitter and receiver pairs together, TX[1-3]-RX[1-4].

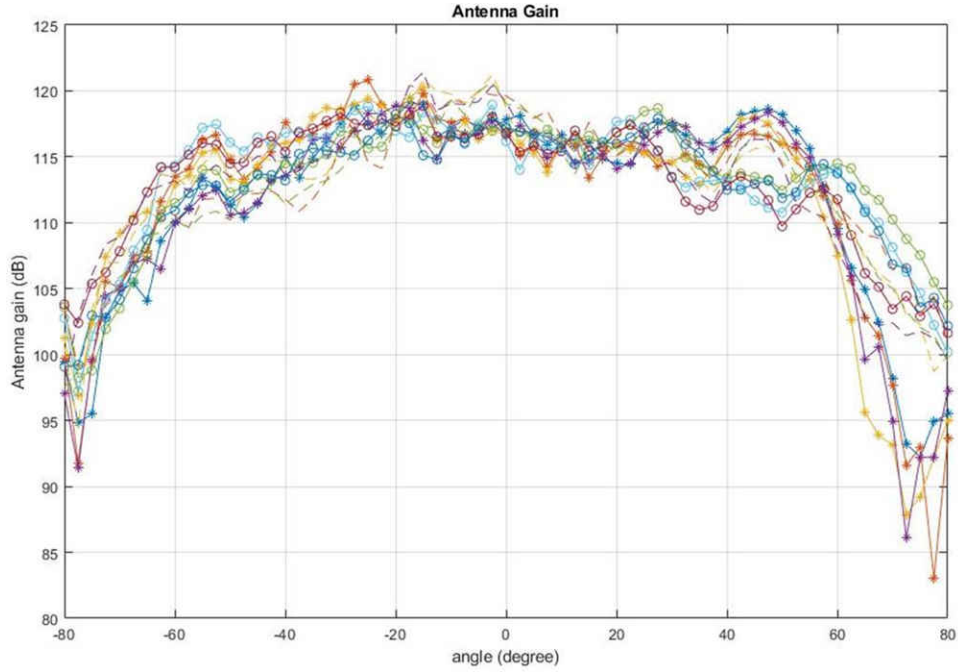

Figure 6-16. Measured Elevation Radiation Pattern for All Tx to Rx Pairs (All 12 Virtual Antenna Pairs Included)

7 IWR6843AOPEVM (Deprecated)



CAUTION HOT SURFACE
CONTACT MAY CAUSE BURN
DO NOT TOUCH

Note

RECOMMENDED DUTY CYCLE: The IWR6843AOPEVM operates at a maximum duty cycle of 50%, running at a higher duty cycle increases the risk of damaging the EVM by exceeding the maximum operating junction temperature (T_j) of 105°C.

7.1 Hardware

The IWR6843AOPEVM includes four receivers and three transmitter wide field of antennas on the package of the device. The IWR6843 operates at 4-GHz bandwidth from 60 to 64 GHz, with a maximum output power of 10 dBm; the IWR6843AOPEVM has an antenna gain of ~6 dBi.

Note

The IWR6843AOPEVM has been tested in the 60-64GHz band across the temperature range of -20°C to 60°C.

Note

In accordance to the EN 62311 RF exposure test, a minimum separation distance of 20 centimeters should be maintained between the user and the EVM during operation.

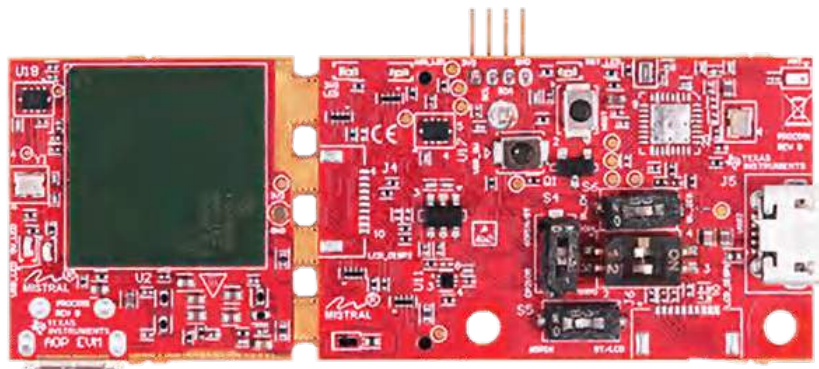

Figure 7-1. IWR6843AOPEVM Top View

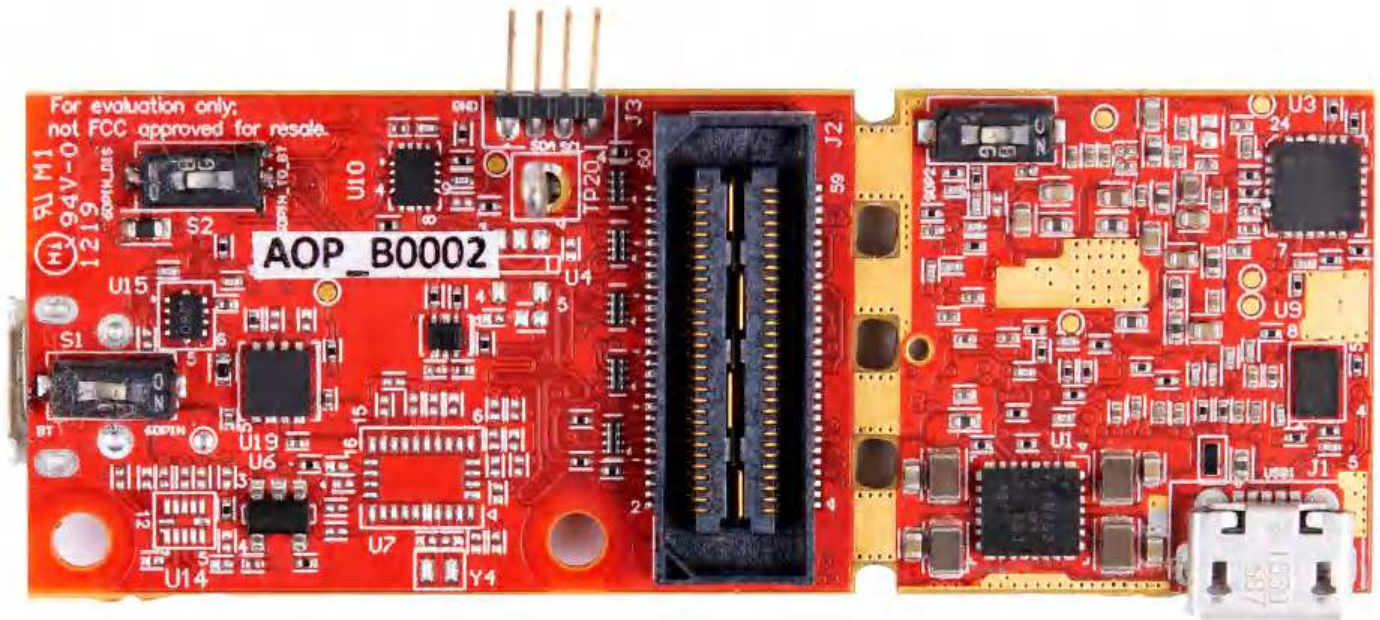

Figure 7-2. IWR6843AOPEVM Bottom View

7.2 Block Diagram

Figure 7-3 shows the functional block diagram. The mission board side contains the essential components for the TI radar system, PMIC, SFLASH, SOP configuration, Filter, TI mmWave Radar chip, and a USB to UART converter. The Breakaway board sections contain the 60-pin Samtec connector for interfacing with the MMWAVEICBOOST.

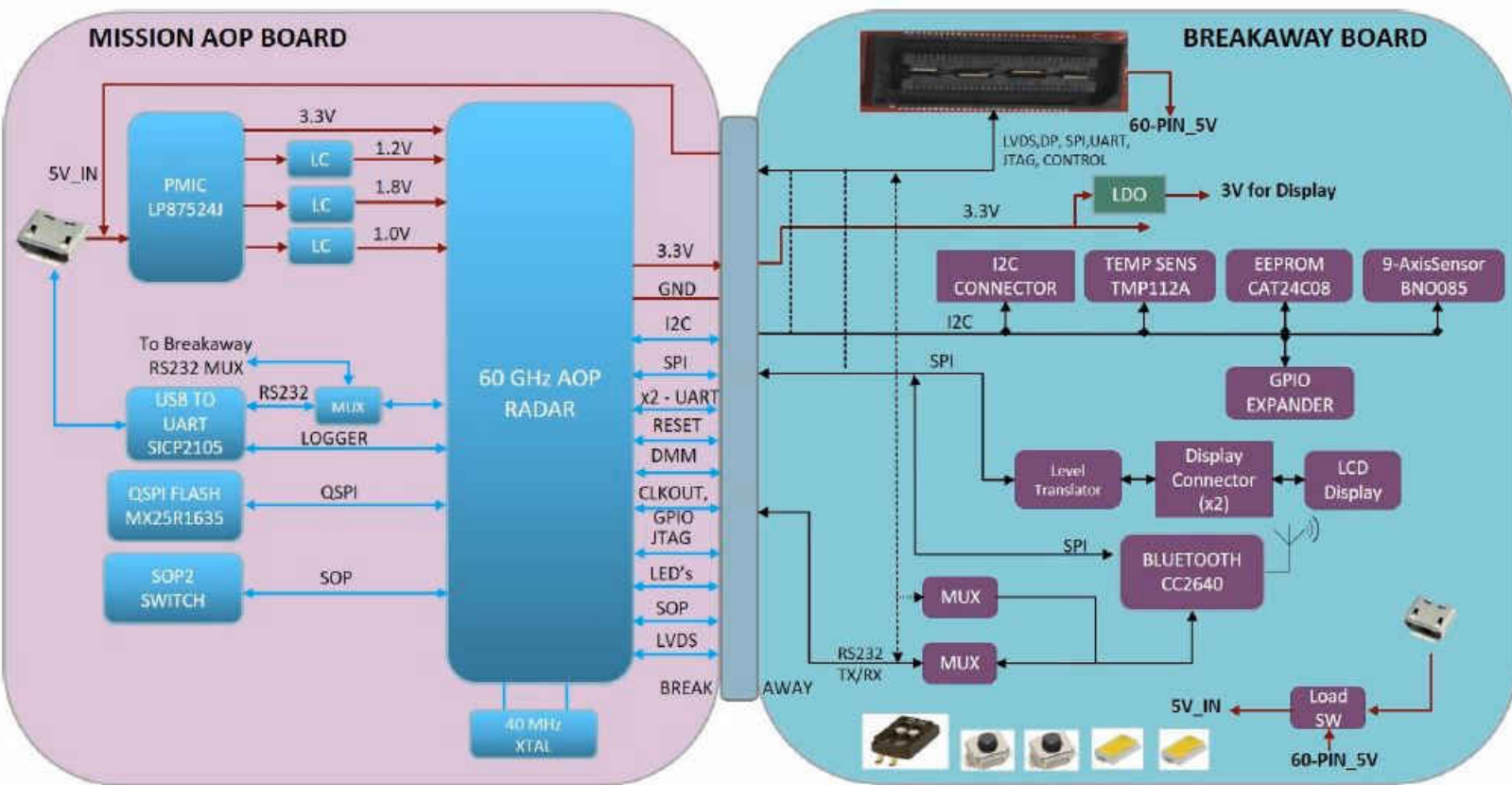

Figure 7-3. Block Diagram of the IWR6843AOPEVM

7.3 PCB Storage and Handling Recommendations

This EVM contains components that can potentially be damaged by electrostatic discharge. Always transport and store the EVM in it's supplied ESD bag when not in use. Handle using an antistatic wristband. Operate on an antistatic work surface. For more information on proper handling, refer to [SSYA010A](#).

7.4 IWR6843AOPEVM Antenna

The IWR6843AOPEVM includes four receiver and three transmitter short range antennas on the package of the chip. [Figure 7-4](#) shows the antenna on package.

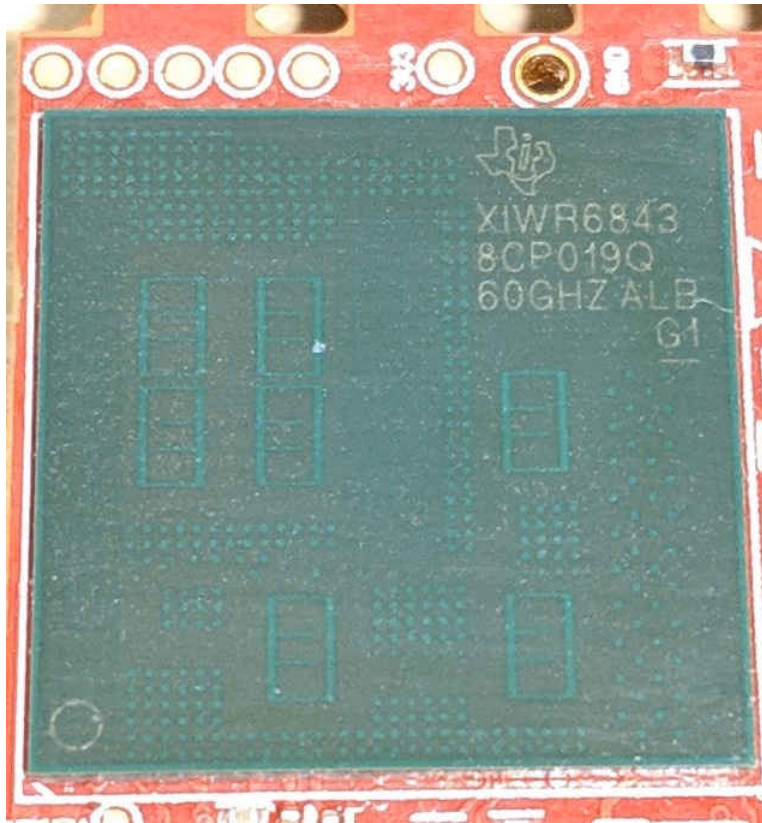

Figure 7-4. AOP Antennas

Figure 7-5 shows the antenna radiation pattern with regard to azimuth. Figure 7-6 shows the antenna radiation pattern with regard to elevation for TX1, TX2, and TX3. Both show the radiation pattern for TX1, TX2, and TX3, and RX1, RX2, RX3, and RX4 together.

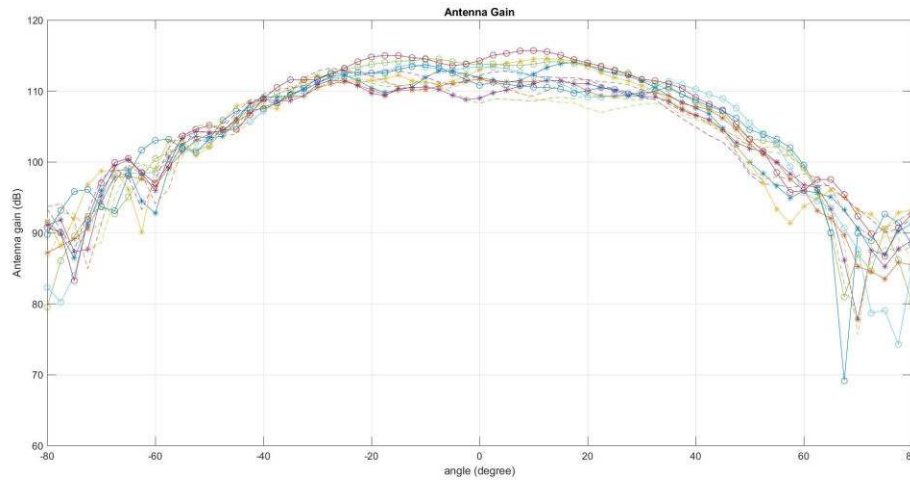

Figure 7-5. Measured Azimuthal Radiation Pattern for All Tx to Rx Pairs (All 12 Virtual Antenna Pairs Included)

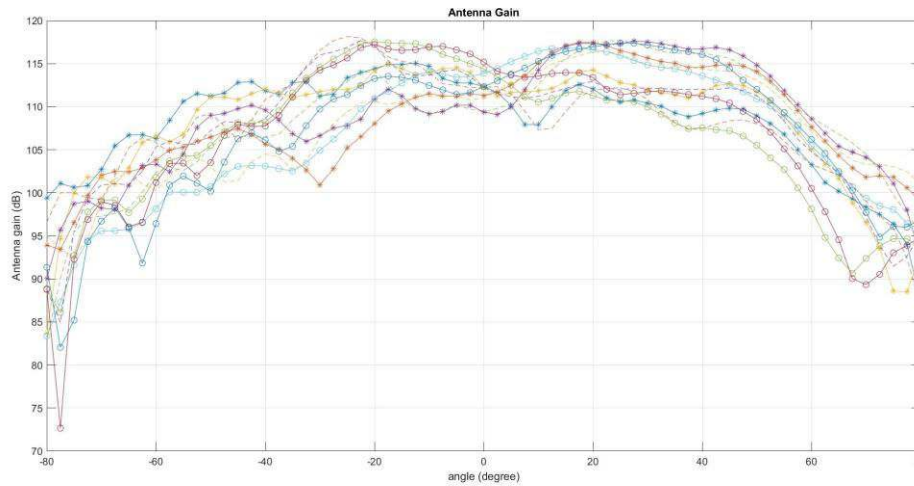

Figure 7-6. Measured Elevation Radiation Pattern for All Tx to Rx Pairs (All 12 Virtual Antenna Pairs Included)

7.5 Switch Settings

Figure 7-7 shows the part designators and positions of the switches on the IWR6843AOPEVM.

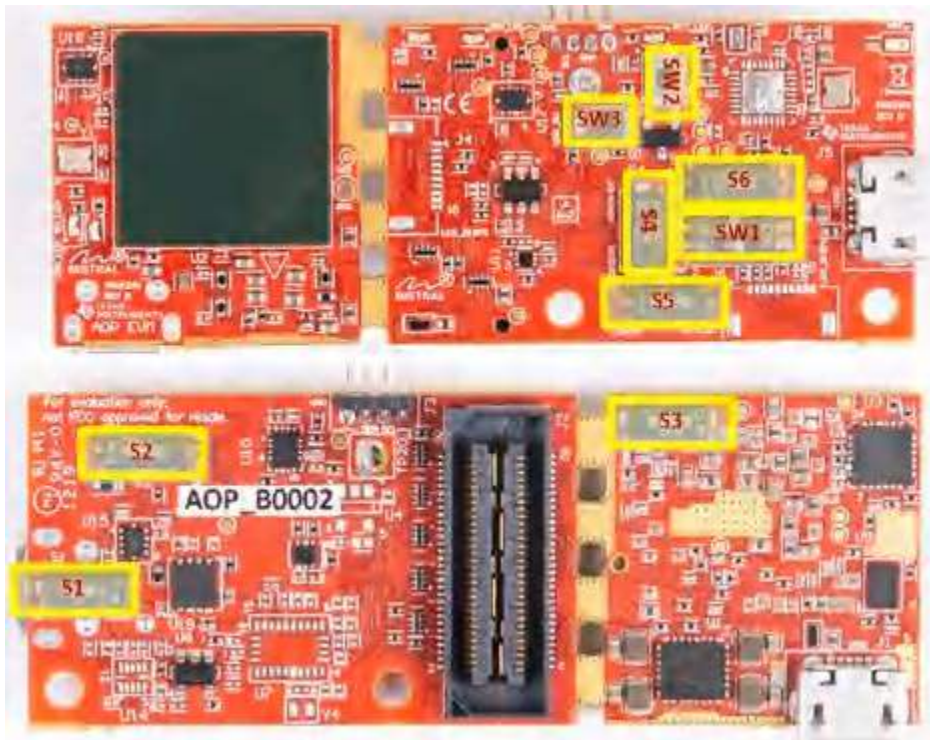

Figure 7-7. IWR6843AOPEVM Switches

Table 7-1. Switches

Reference Designator	Switch ON	Switch OFF
S1	60-pin connector	Bluetooth
S2	Disable 60-pin to Bluetooth	Enable 60-pin to Bluetooth
S3	SOP2 Pull up	SOP2 pull down
S4	Breakaway UART	Mainboard UART
S5	60-pin connector	Bluetooth/LCD
S6	Bluetooth Enable	Bluetooth Disable
SW1-1	SOP1 pull up	SOP1 pull down
SW1-2	SOP0 pull down	SOP0 pull up
SW2	Reset switch	
SW3	User switch	

7.6 IWR6843AOPEVM Muxing Scheme

The IWR6843AOPEVM UART RX/TX can be routed to the Samtec 60-pin connector, USB to UART (SICP2105), and bluetooth (BT) device (CC2640R2F), as detailed in [Table 7-2](#) and [Table 7-3](#).

Table 7-2. Pin Mux Settings I

Reference Designator	Switch ON	Switch OFF
S1	60-Pin Connector	BT
S2	Disable 60-pin to BT	Enable 60-pin to BT
S4	Breakaway UART	Mainboard UART
S5	60-Pin Connector	BT/LCD
S6	BT Enable	BT Disable

Table 7-3. Pin Mux Settings II

	S1	S2	S4	S5	S6
Modular Mode SICP2015, see Figure 7-8	N/A	ON	OFF	N/A	N/A
Modular Mode - CC2640R2F, see Figure 7-9	OFF	OFF	ON	OFF	ON
MMWAVEICBOOST - Samtec 60-Pin Conn, see Figure 7-10	ON	ON	ON	ON	OFF

7.6.1 SOP Configuration

	SOP0(SW1 ²)	SOP1(SW1 ¹)	SOP2(S3)
Flashing	OFF	OFF	ON
Functional	OFF	OFF	OFF
MMWAVEICBOOST Mode (DCA1000, JTAG, and so forth)	ON	OFF	OFF

Note

SOP0 is set high when switch is on the OFF position and low when the switch is the ON position. SOP 1 and 2 are set low when the switch is OFF and high when the switch is ON.

In mounted mode, the IWR6843AOPEVM is mounted on the MMWAVEICBOOST and the SOP mode is set by the MMWAVEICBOOST.

7.7 Modular and MMWAVEICBOOST Mode

The IWR6843AOP can be used in modular mode or mounted on the MMWAVEICBOOST for debugging.

7.7.1 Modular Mode

When used in modular mode, the UART can either be routed to the SICP2015, which displays the data on the mmWave visualizer, or to other devices connected to the USB interface. The UART data can also be routed to the CC2640R2F, which transmits data to a wireless device through Bluetooth. [Figure 7-8](#) shows the setup for SICP2015. [Figure 7-9](#) shows the setup for CC2640R2F. ³

³ For higher power application ensure the USB J1 is connected before connecting USB J5.

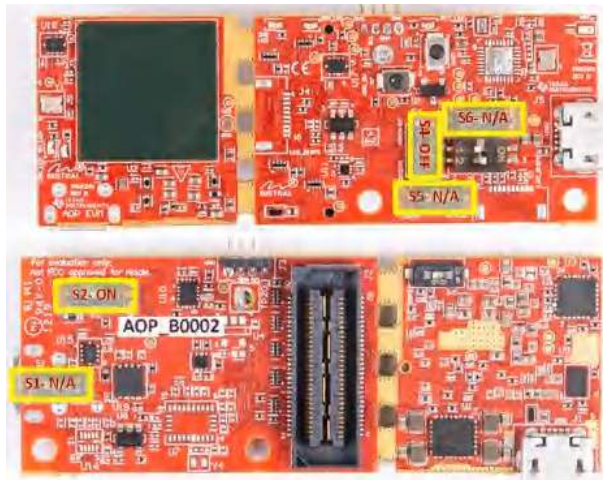

Figure 7-8. Switch Configuration for Modular Mode

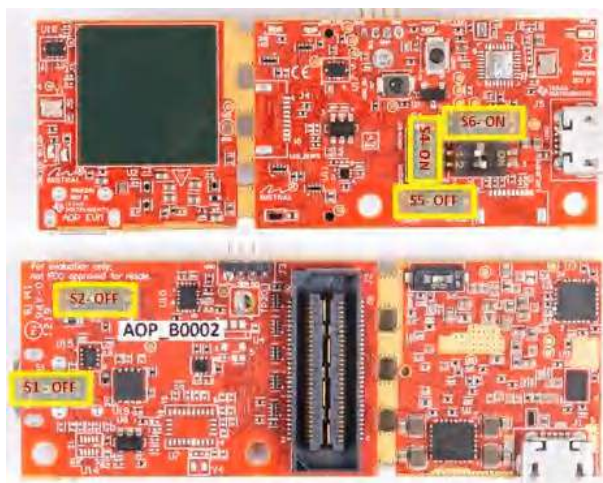
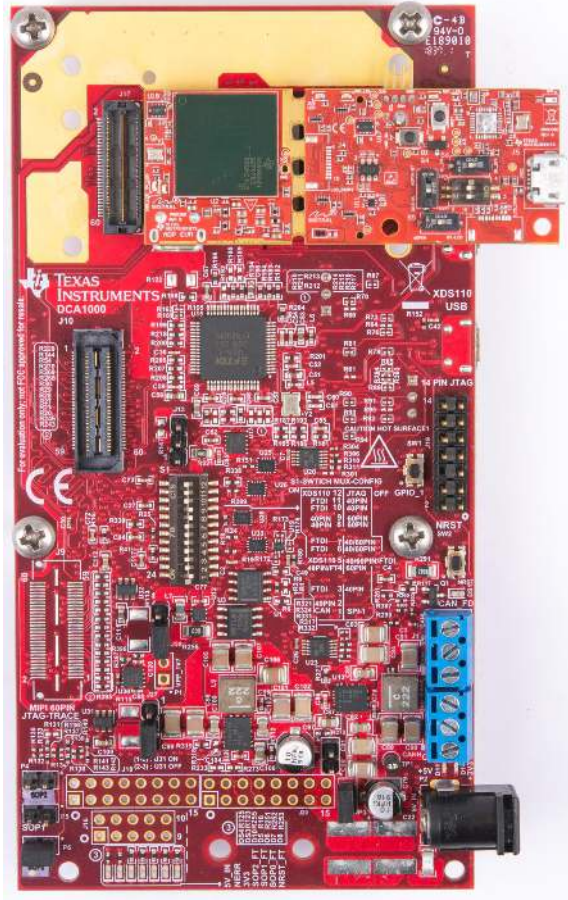

Figure 7-9. Switch Configuration for BT Mode

7.7.2 MMWAVEICBOOST Mode

This mode enables access to debugging tools available on the MMWAVEICBOOST such as the JTAG, ADC capture, CAN, LaunchPad connector, and so forth.



For mounted mode, the UART should be routed to the 60-pin connector. Set up the device as shown in [Figure 7-10](#). When mounted as shown, the SOP mode is overridden by the MMWAVEICBOOST SOP configuration.

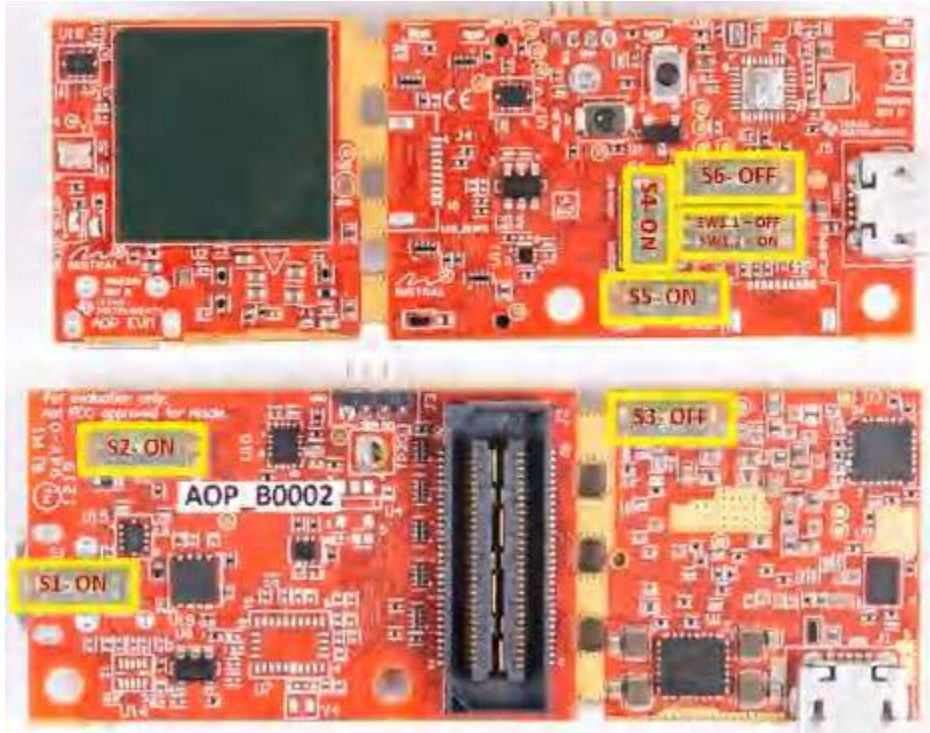

Figure 7-10. Switch Configuration for MMWAVEICBOOST Mode

When mounted and setup correctly, the MMWAVEICBOOST can be used same as the IWR6843ISK and IWR6843ODS with DCA1000EVM, LaunchPads, and so forth.

7.8 PC Connection

7.8.1 Installing the Drivers

The SICIP2105 drivers must be installed to access the UART port. Download and install the drivers [here](#).

When installed correctly, the COM port should be enumerated as shown in [Figure 7-11](#).

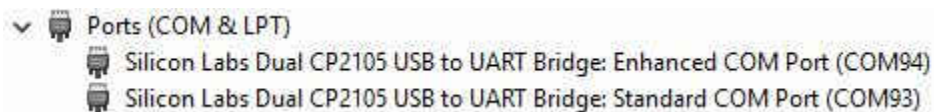

Figure 7-11. SICIP2015 COM Ports

The enhanced COM port is the application/user UART and the standard COM port is the data port.

7.8.2 Flashing the Board

1. Ensure the drivers have been successfully installed and COM ports enumerated.
2. Configure the SOP to flashing mode.
3. Run the UniFlash tool.
4. Press the reset switch to ensure that the board boots up in the right mode.
5. Enter the Enhanced COM Port in the UniFlash interface.
6. Load image to serial flash.

7.8.3 DCA1000

For data capture using the DCA1000, set up the board to mounted mode, having the SOP and UART muxed set correctly. Continue as you would with the xWR6843ISK. For more information, see [Section 2.5.3](#).

7.9 REACH Compliance

In compliance with the Article 33 provision of the EU REACH regulation, this is to notify you that this EVM includes component(s) containing at least one substance of very high concern (SVHC) above 0.1%. The uses from Texas Instruments do not exceed 1 ton per year. The SVHC's are:

Component Manufacturer	Component Type	Component Part Number	SVHC Substance	SVHC CAS (when available)
Bivar	LED	SM0402GC	1,3,5-tris(oxiranylmethyl)-1,3,5-triazine-2,4,6(1H,3H,5H)-trione	2451-62-9

8 TI E2E Community

Search the forums at e2e.ti.com. If you cannot find your answer, post your question to the community!

9 Certification Related Information

For certification related information please see certification collateral on [TIREX](#)

Per the Radio Equipment Directive (RED) requirement for sales in Europe the evaluation modules operate in the 57 – 64 GHz band with a declared max mean power as detailed in the following table.

Table 9-1. Declared Maximum Mean Power

Model	Declared Power (mW EIRP)	Declared Power (dBm EIRP)
IWR6843ISK 1	14	11.5
IWR6843ISK-ODS 1	27	14.3
IWR6843AOPEVM 1	23	13.6

1. for more information on test and chirp setup for the test, see [TIREX](#) page

Revision History

NOTE: Page numbers for previous revisions may differ from page numbers in the current version.

Changes from November 1, 2020 to May 30, 2022 (from Revision D (November 2020) to Revision E (May 2022))

	Page
• Added Note to xWR6843ISK / IWR6843ISK-ODS REV C section.....	29
• Added Note to xWR6843AOPEVM Rev F section.....	46
• Added Regulatory Statements with Respect to the xWR6843AOPEVM Rev G section.....	60
• Added Note to xWR6843AOPEVM Rev F section.....	61

IMPORTANT NOTICE AND DISCLAIMER

TI PROVIDES TECHNICAL AND RELIABILITY DATA (INCLUDING DATA SHEETS), DESIGN RESOURCES (INCLUDING REFERENCE DESIGNS), APPLICATION OR OTHER DESIGN ADVICE, WEB TOOLS, SAFETY INFORMATION, AND OTHER RESOURCES "AS IS" AND WITH ALL FAULTS, AND DISCLAIMS ALL WARRANTIES, EXPRESS AND IMPLIED, INCLUDING WITHOUT LIMITATION ANY IMPLIED WARRANTIES OF MERCHANTABILITY, FITNESS FOR A PARTICULAR PURPOSE OR NON-INFRINGEMENT OF THIRD PARTY INTELLECTUAL PROPERTY RIGHTS.

These resources are intended for skilled developers designing with TI products. You are solely responsible for (1) selecting the appropriate TI products for your application, (2) designing, validating and testing your application, and (3) ensuring your application meets applicable standards, and any other safety, security, regulatory or other requirements.

These resources are subject to change without notice. TI grants you permission to use these resources only for development of an application that uses the TI products described in the resource. Other reproduction and display of these resources is prohibited. No license is granted to any other TI intellectual property right or to any third party intellectual property right. TI disclaims responsibility for, and you will fully indemnify TI and its representatives against, any claims, damages, costs, losses, and liabilities arising out of your use of these resources.

TI's products are provided subject to [TI's Terms of Sale](#) or other applicable terms available either on ti.com or provided in conjunction with such TI products. TI's provision of these resources does not expand or otherwise alter TI's applicable warranties or warranty disclaimers for TI products.

TI objects to and rejects any additional or different terms you may have proposed.

Mailing Address: Texas Instruments, Post Office Box 655303, Dallas, Texas 75265
Copyright © 2022, Texas Instruments Incorporated