

## SDURD1040CT ULTRAFAST RECTIFIER

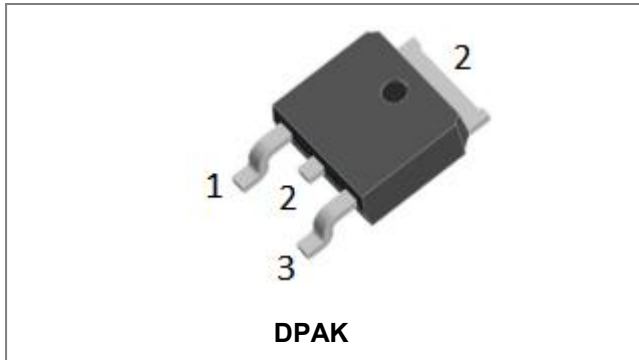

### Applications

- Antiparallel diode for high frequency switching devices
- Anti saturation diode
- Snubber diode
- Free wheeling diode in converters and motor control circuits
- Rectifiers in switch mode power supplies (SMPS)
- Inductive heating and melting
- Uninterruptible power supplies (UPS)
- Ultrasonic cleaners and welders

### Circuit Diagram

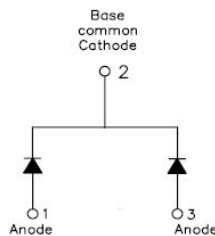

### Features

- Ultra-Fast switching
- High current capability
- Low reverse leakage current
- High surge current capability
- This is a Pb – free device
- All SMC parts are traceable to the wafer lot
- Additional testing can be offered upon request

### Maximum Ratings:

Characteristics	Symbol	Condition	Max.	Units
Peak Repetitive Reverse Voltage	$V_{RRM}$	-	400	V
Working Peak Reverse Voltage	$V_{RWM}$			
DC Blocking Voltage	$V_R$			
Average Rectified Forward Current	$I_{F(AV)}$	50% duty cycle @ $T_c=112^\circ\text{C}$ , rectangular wave form	5(Per Leg) 10(Per Device)	A
Peak One Cycle Non-Repetitive Surge Current(Per Leg)	$I_{FSM}$	8.3ms, Half Sine pulse	80	A

### Electrical Characteristics:

Characteristics	Symbol	Condition	Typ.	Max.	Units
Forward Voltage Drop (Per Leg)*	$V_{F1}$	@ 5A, Pulse, $T_J = 25^\circ\text{C}$	0.95	1.3	V
	$V_{F2}$	@ 5A, Pulse, $T_J = 125^\circ\text{C}$	0.88	1.2	V
Reverse Current (Per Leg)*	$I_{R1}$	@ $V_R = \text{rated } V_R, T_J = 25^\circ\text{C}$	0.4	30	$\mu\text{A}$
	$I_{R2}$	@ $V_R = \text{rated } V_R, T_J = 125^\circ\text{C}$	15	500	$\mu\text{A}$
Reverse Recovery Time(Per Leg)	$t_{rr}$	$I_F=500\text{mA}, I_R=1\text{A}, \text{and } I_{sm}=250\text{mA}$	38	45	ns

\* Pulse width < 300  $\mu\text{s}$ , duty cycle < 2%

- China - Germany - Korea - Singapore - United States •
- <http://www.smc-diodes.com> - [sales@smc-diodes.com](mailto:sales@smc-diodes.com) •

**Thermal-Mechanical Specifications:**

Characteristics	Symbol	Condition	Specification	Units
Junction Temperature	$T_J$	-	-55 to +150	°C
Storage Temperature	$T_{stg}$	-	-55 to +150	°C
Typical Thermal Resistance Junction to Case	$R_{\theta JC}$	DC operation	3.5	°C/W
Approximate Weight	wt	-	0.39	g
Case Style	DPAK			

**Ratings and Characteristics Curves**

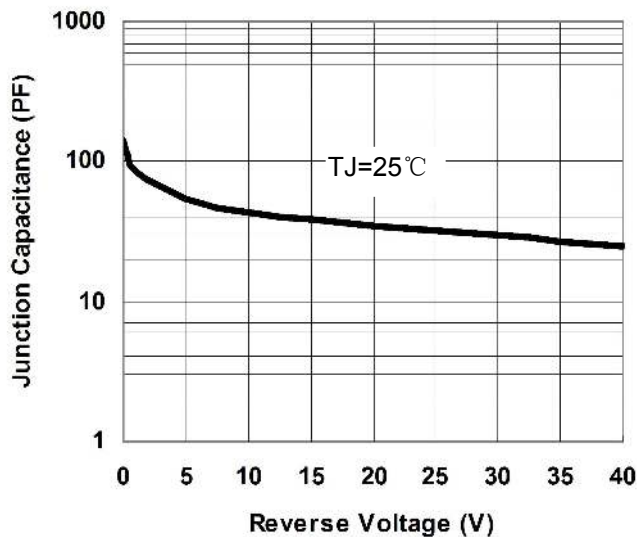

Fig.1-Typical Junction Capacitance

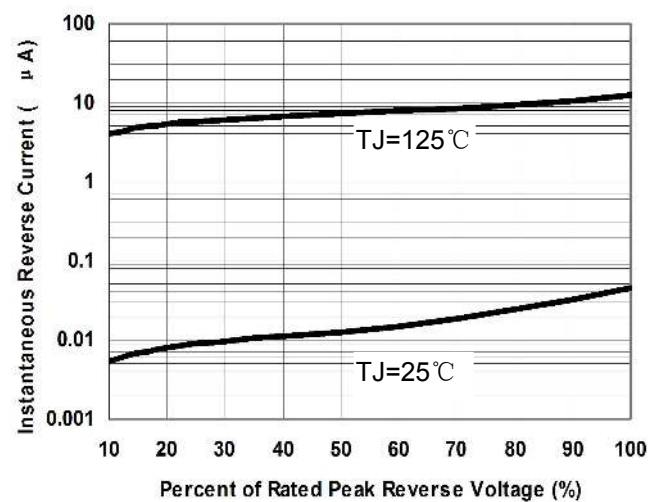

Fig.2-Typical Reverse Characteristics

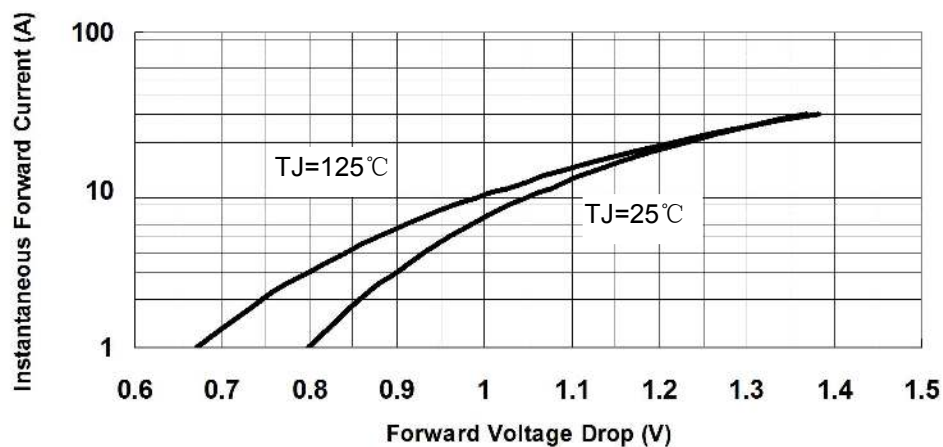
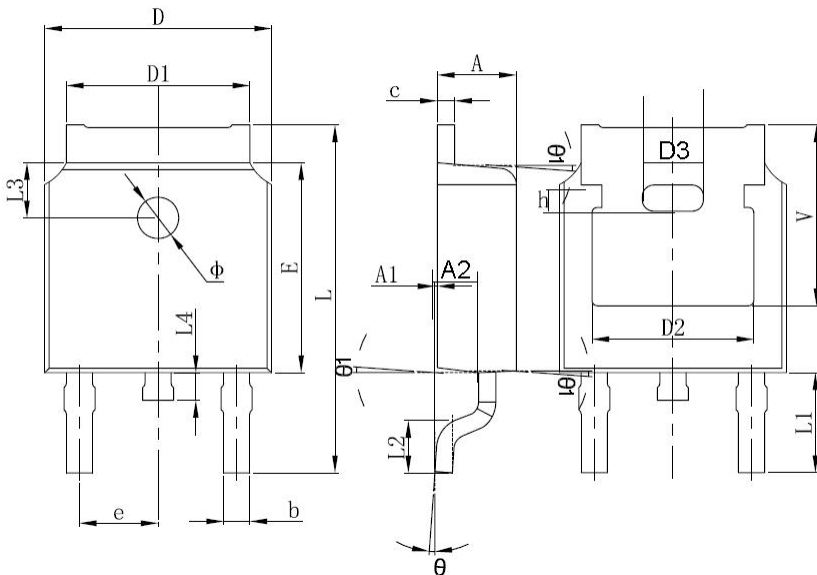

Fig.3-Typical Instantaneous Forward Voltage Characteristics

**Mechanical Dimensions DPAK**



SYMBOL	Millimeters		Inches	
	Min.	Max.	Min.	Max.
A	2.20	2.40	0.087	0.094
A1	0.00	0.127	0.000	0.005
b	0.66	0.86	0.026	0.034
c	0.46	0.60	0.018	0.024
D	6.50	6.70	0.256	0.264
D1	5.13	5.46	0.202	0.215
D2	4.83 REF.		0.190 REF.	
E	6.00	6.20	0.236	0.244
e	2.186	2.386	0.086	0.094
L	9.70	10.40	0.381	0.409
L1	2.90 REF.		0.144 REF.	
L2	1.40	1.70	0.055	0.067
L3	1.60 REF.		0.063 REF.	
L4	0.60	1.00	0.024	0.039
Φ	1.10	1.30	0.043	0.051
Θ	0°	8°	0°	8°
h	0.00	0.30	0.000	0.012
V	5.35 REF.		0.211 REF.	

**Ordering Information**

Device	Package	Shipping
SDURD1040CT	DPAK (Pb-Free)	2500pcs / reel

For information on tape and reel specifications, including part orientation and tape sizes, please refer to our tape and reel Packaging specification.

**Marking Diagram**



Where XXXXX is YYWWL

SDUR = Device Type  
D = Package type  
10 = Forward Current (10A)  
40 = Reverse Voltage (400V)  
CT = Configuration  
SSG = SSG  
YY = Year  
WW = Week  
L = Lot Number

**Cautions:** Molding resin  
Epoxy resin UL:94V-0

**Carrier Tape Specification DPAK**

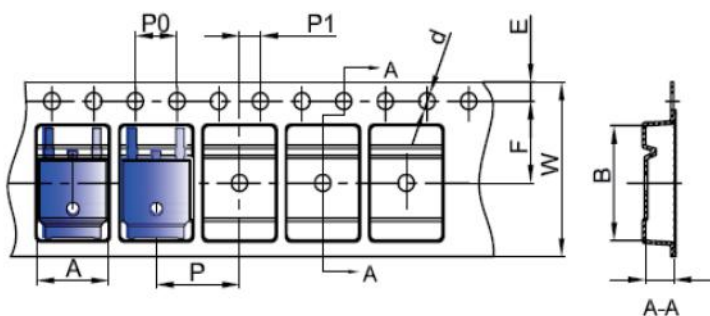

SYMBOL	Millimeters	
	Min.	Max.
A	6.80	7.00
B	10.40	10.60
C	2.60	2.80
d	Φ1.45	Φ1.65
E	1.65	1.85
F	7.40	7.60
P0	3.90	4.10
P	7.90	8.10
P1	1.90	2.10
W	15.90	16.30



**DISCLAIMER:**

- 1- The information given herein, including the specifications and dimensions, is subject to change without prior notice to improve product characteristics. Before ordering, purchasers are advised to contact the SMC - Sangdest Microelectronics (Nanjing) Co., Ltd sales department for the latest version of the datasheet(s).
- 2- In cases where extremely high reliability is required (such as use in nuclear power control, aerospace and aviation, traffic equipment, medical equipment, and safety equipment), safety should be ensured by using semiconductor devices that feature assured safety or by means of users' fail-safe precautions or other arrangement.
- 3- In no event shall SMC - Sangdest Microelectronics (Nanjing) Co., Ltd be liable for any damages that may result from an accident or any other cause during operation of the user's units according to the datasheet(s). SMC - Sangdest Microelectronics (Nanjing) Co., Ltd assumes no responsibility for any intellectual property claims or any other problems that may result from applications of information, products or circuits described in the datasheets.
- 4- In no event shall SMC - Sangdest Microelectronics (Nanjing) Co., Ltd be liable for any failure in a semiconductor device or any secondary damage resulting from use at a value exceeding the absolute maximum rating.
- 5- No license is granted by the datasheet(s) under any patents or other rights of any third party or SMC - Sangdest Microelectronics (Nanjing) Co., Ltd.
- 6- The datasheet(s) may not be reproduced or duplicated, in any form, in whole or part, without the expressed written permission of SMC - Sangdest Microelectronics (Nanjing) Co., Ltd.
- 7- The products (technologies) described in the datasheet(s) are not to be provided to any party whose purpose in their application will hinder maintenance of international peace and safety nor are they to be applied to that purpose by their direct purchasers or any third party. When exporting these products (technologies), the necessary procedures are to be taken in accordance with related laws and regulations..