

REVISIONS					
P	LTR	DESCRIPTION	DATE	DWN	APVD
	A1	NEW DRAWING CREATED	25.03.03	ABR	-
	A1	REVISED PER ECN-21-128636	02DEC2021	WLS	VS

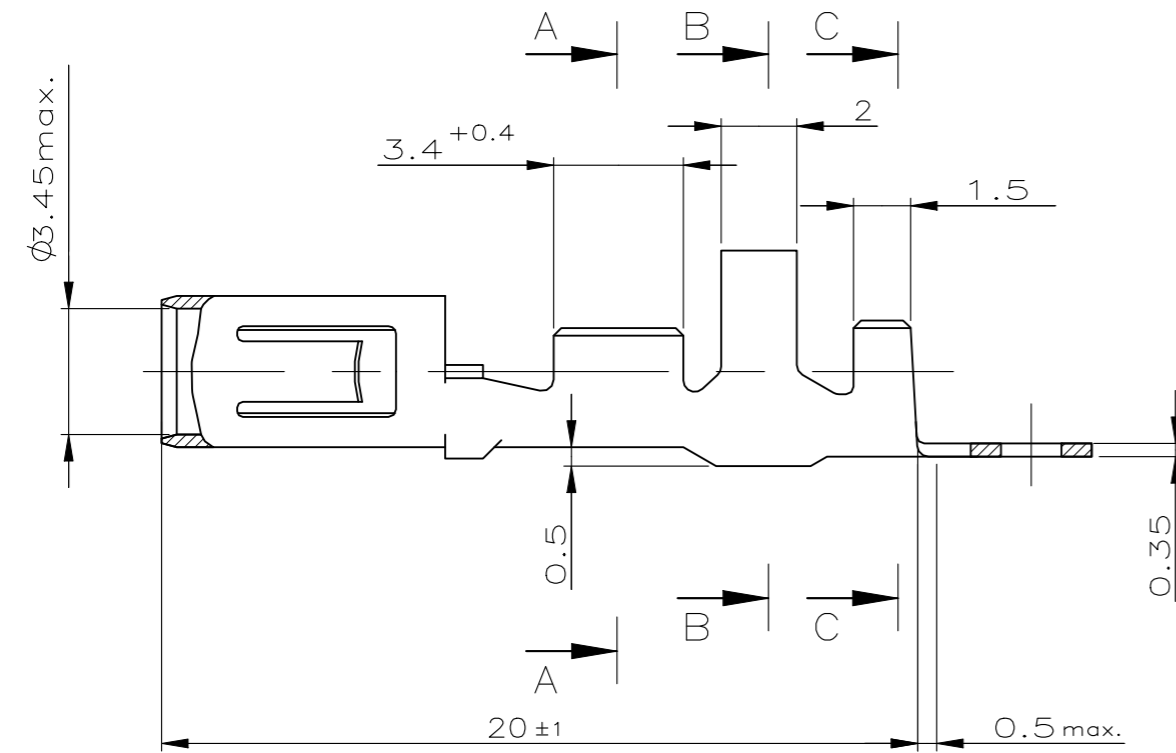

Schnitt SECTION A-A

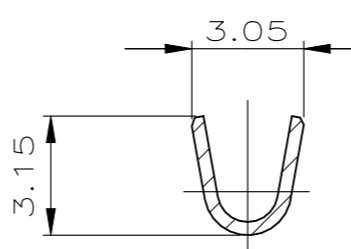

Schnitt SECTION B-B

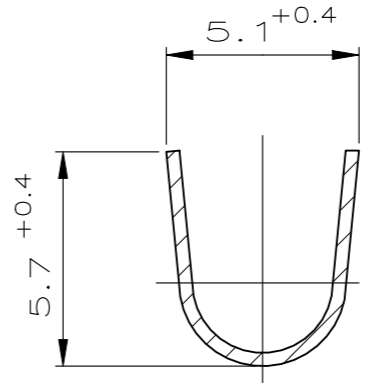

Schnitt SECTION C-C

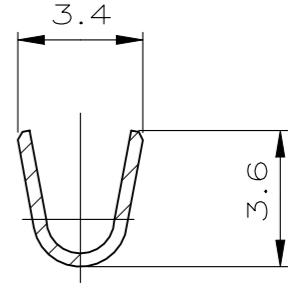

Schnitt SECTION D-D

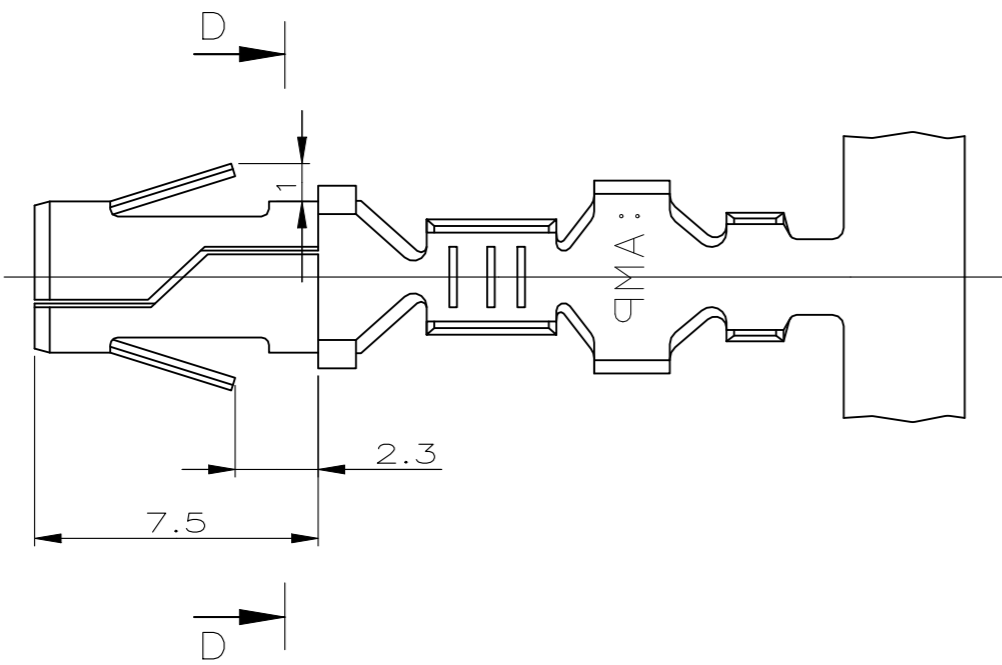
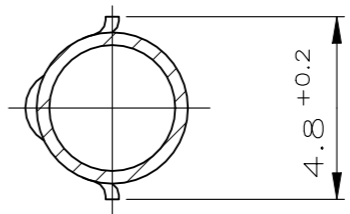
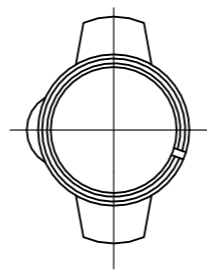

-	-	-	-
PRETIN	CuSn4	926986-2	A
PRETIN	CuZn30	926986-1	A
FINISH	MATERIAL	AMP PART NO	REV.

THIS DRAWING IS A CONTROLLED DOCUMENT.		DWN Abraham,G. 24-MAR-03	TE Connectivity		
		CHK Kampmann,H. 25-MAR-03			
DIMENSIONS: mm		TOLERANCES UNLESS OTHERWISE SPECIFIED:		NAME .140 DIA SOCKET	
		0 PLC ± -	PRODUCT SPEC 108-1032		RESTRICTED TO
		1 PLC ± 0.2	APPLICATION SPEC 114-1007		
MATERIAL		2 PLC ± -	SIZE A3	CAGE CODE 00779	DRAWING NO C-926986
		3 PLC ± -	SCALE 5:1		SHEET 1 OF 1
		4 PLC ± -	CUSTOMER DRAWING		REV A1
		ANGLES ± -			
		FINISH			