

**NEW Product**

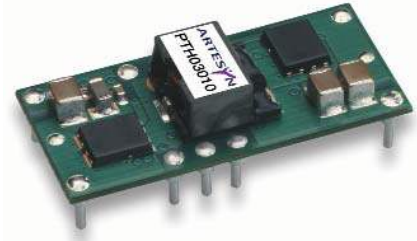

- 15 A output current
- 3.3 V input voltage
- Wide-output voltage adjust (0.8 V to 2.5 V)
- Auto-track™ sequencing\*
- Margin up/down controls
- Pre-bias start-up capability
- Efficiencies up to 93%
- Output ON/OFF inhibit
- Output voltage sense
- Point-of-Load-Alliance (POLA) compatible
- Available RoHS compliant



The PTH03010 is a next generation series of non-isolated dc-dc converters offering some of the most advanced POL features available in the industry. The primary new feature provides for sequencing between multiple modules, a function, which is becoming a necessity for powering advanced silicon including DSP's, FPGA's and ASIC's requiring controlled power-up and power-down. Other industry leading features include margin up/down controls, pre-bias start-up capability and efficiencies up to 93%. The PTH03010 has an input voltage of 2.95 V to 3.65 V and offers a wide 0.8 V to 2.5 V output voltage range with up to 15 A output current, which allows for maximum design flexibility and a pathway for future upgrades.



**2 YEAR WARRANTY**

All specifications are typical at nominal input, full load at 25 °C unless otherwise stated  
C<sub>in</sub> = 470 µF, C<sub>out</sub> = 0 µF

## SPECIFICATIONS

### OUTPUT SPECIFICATIONS

Voltage adjustability	(See Note 4)	0.8-2.5 V
Setpoint accuracy		±2.0% V <sub>o</sub>
Line regulation		±10 mV typ.
Load regulation		±12 mV typ.
Total regulation		±3.0% V <sub>o</sub>
Minimum load		0 A
Ripple and noise	20 MHz bandwidth	20 mV pk-pk
Temperature co-efficient	-40 °C to +85 °C	±0.5% V <sub>o</sub>
Transient response (See Note 5)		70 µs recovery time Overshoot/undershoot 100 mV
Margin adjustment		±5.0% V <sub>o</sub>

### INPUT SPECIFICATIONS

Input voltage range	(See Note 3)	2.95-3.65 V
Input current	No load	10 mA typ.
Remote ON/OFF	(See Note 1)	Positive logic
Start-up time		1 V/ms
Undervoltage lockout		2.8-2.95 V typ.
Track input voltage	Pin 8 (See Note 6, 7)	±0.3 V <sub>in</sub>

### EMC CHARACTERISTICS

Electrostatic discharge	EN61000-4-2, IEC801-2
Conducted immunity	EN61000-4-6
Radiated immunity	EN61000-4-3

### GENERAL SPECIFICATIONS

Efficiency	(See Efficiency Table)	93% max.
Insulation voltage		Non-isolated
Switching frequency		300 kHz typ. ±25 kHz
Approvals and standards		EN60950 UL/cUL60950
Material flammability		UL94V-0
Dimensions	(L x W x H)	34.80 x 15.75 x 9.00 mm 1.370 x 0.620 x 0.354 in
Weight		5 g (0.18 oz)
MTBF	Telcordia SR-332	7,092,000 hours

### ENVIRONMENTAL SPECIFICATIONS

Thermal performance (See Note 2)	Operating ambient, temperature Non-operating	-40 °C to +85 °C -40 °C to +125 °C
MSL ('Z' suffix only)	JEDEC J-STD-020C	Level 3

### PROTECTION

Short-circuit	Auto reset	27.5 A typ.
---------------	------------	-------------

### International Safety Standard Approvals



UL/cUL CAN/CSA-C22.2 No. 60950-1-03/UL 60950-1,  
File No. E174104



TÜV Product Service (EN60950) Certificate No. B 04 06 38572 044  
CB Report and Certificate to IEC60950, Certificate No.  
US/8292/UL

\*Auto-track™ is a trade mark of  
Texas Instruments

OUTPUT POWER (MAX.)	INPUT VOLTAGE	OUTPUT VOLTAGE	OUTPUT CURRENT (MIN.)	OUTPUT CURRENT (MAX.)	EFFICIENCY (MAX.)	REGULATION		MODEL NUMBER <sup>(9,10)</sup>
						LINE	LOAD	
37.5 W	2.95-3.65 V	0.8-2.5 V	0 A	15 A	93%	±10 mV	±12 mV	PTH03010

Part Number System with Options

**PTH03010WAST**

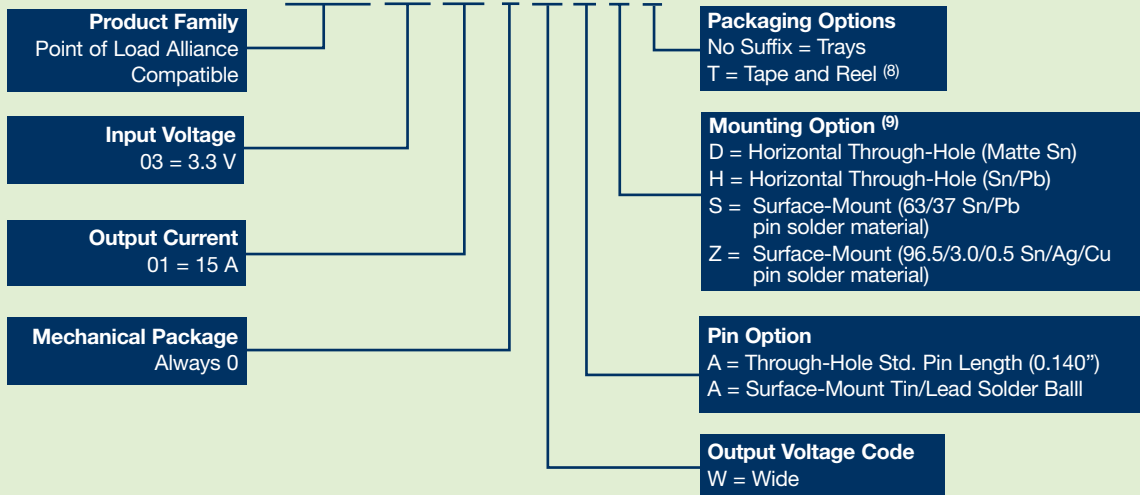

**Output Voltage Adjustment of the PTH03010 Series**

The ultra-wide output voltage trim range offers major advantages to users who select the PTH03010. It is no longer necessary to purchase a variety of modules in order to cover different output voltages. The output voltage can be trimmed in a range of 0.8 Vdc to 2.5 Vdc. When the PTH03010 converter leaves the factory the output has been adjusted to the default voltage of 0.8 V.

**Notes**

- Remote ON/OFF. Positive Logic  
ON: Pin 3 open; or  $V > V_{in} - 0.5 V$   
OFF: Pin 3 GND; or  $V < 0.8 V$  (min - 0.2 V).
- See Figures 1 and 2 for safe operating curves.
- A 470  $\mu F$  electrolytic input capacitor is required for proper operation. The capacitor must be rated for a minimum of 700 mA rms of ripple current.
- An external output capacitor is not required for basic operation. Adding 330  $\mu F$  of distributed capacitance at the load will improve the transient response.
- 1 A/ $\mu s$  load step, 50 to 100%  $I_{o,max}$ ;  $C_{out} = 330 \mu F$ .
- If utilized  $V_{out}$  will track applied voltage by  $\pm 0.3 V$  (up to  $V_o$  set point).
- The pre-bias start-up feature is not compatible with Auto-Track™. This is because when the module is under Auto-Track™ control, it is fully active and will sink current if the output voltage is below that of a back-feeding source. Therefore to ensure a pre-bias hold-off, one of the following two techniques must be followed when input power is first applied to the module. The Auto-Track™ function must either be disabled, or the module's output held off using the Inhibit pin. Refer to Application Note 150 for more details.
- Tape and reel packaging only available on the surface-mount versions.
- To order Pb-free (RoHS compatible) surface-mount parts replace the mounting option 'S' with 'Z', e.g. PTH03010WAZ. To order Pb-free (RoHS compatible) through-hole parts replace the mounting option 'H' with 'D', e.g. PTH03010WAD.
- NOTICE: Some models do not support all options. Please contact your local Artesyn representative or use the on-line model number search tool at <http://www.artesyn.com/powergroup/products.htm> to find a suitable alternative.

**EFFICIENCY TABLE ( $I_o = 10 A$ )**

OUTPUT VOLTAGE	EFFICIENCY
$V_o = 1.0 V$	85%
$V_o = 1.2 V$	87%
$V_o = 1.5 V$	89%
$V_o = 1.8 V$	91%
$V_o = 2.0 V$	92%
$V_o = 2.5 V$	93%

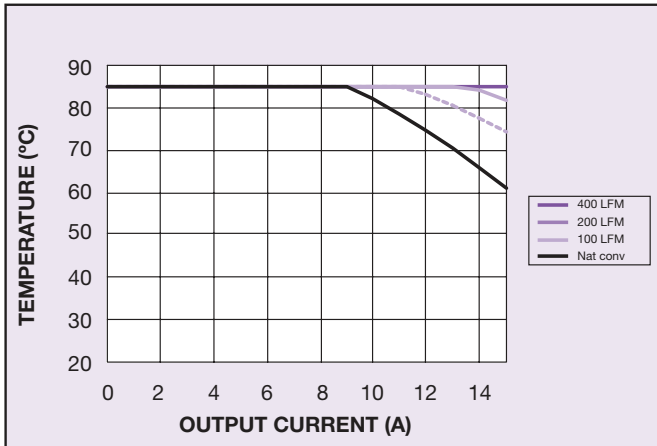

**Figure 1 - Safe Operating Area**  
Vin = 3.3 V, Output Voltage = 2.5 V (See Note A)

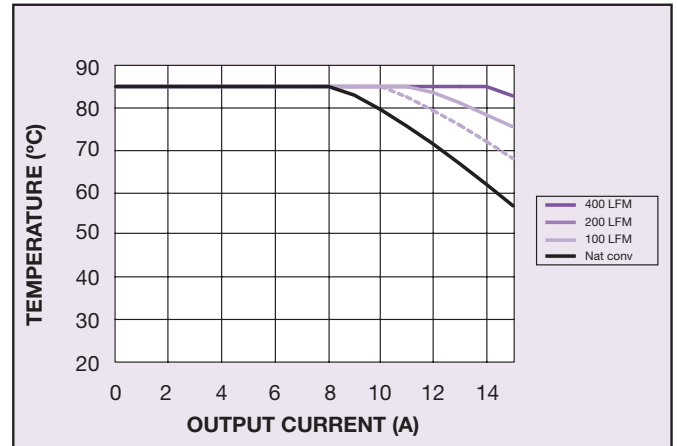

**Figure 2 - Safe Operating Area**  
Vin = 3.3 V, Output Voltage = 1.0 V (See Note A)

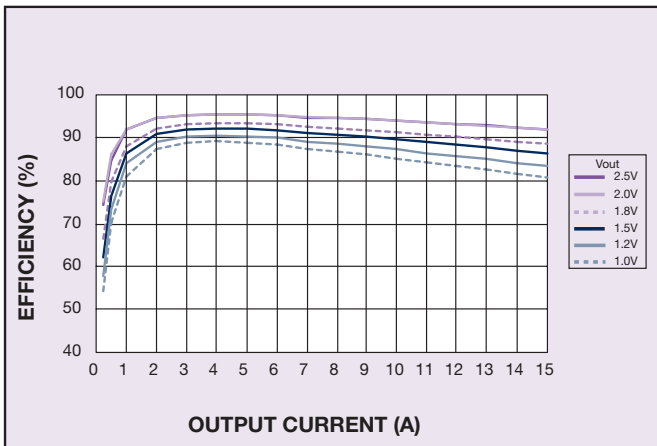

**Figure 3 - Efficiency vs Load Current**  
Vin = 3.3 V (See Note B)

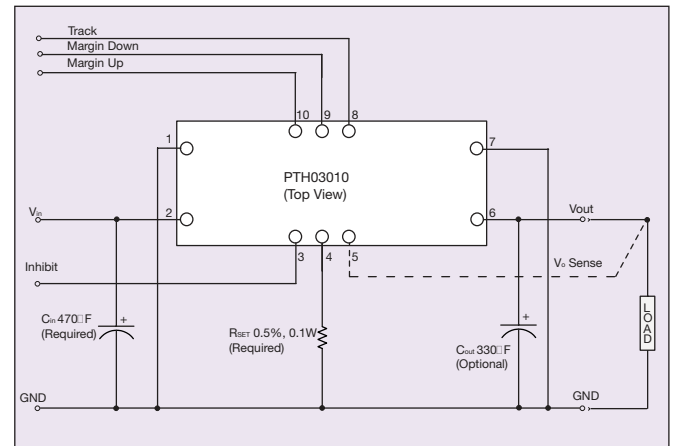

**Figure 4 - Standard Application**

### Notes

- A** SOA curves represent the conditions at which internal components are within the Artesyn derating guidelines.
- B** Characteristic data has been developed from actual products tested at 25 °C. This data is considered typical data for the converter.

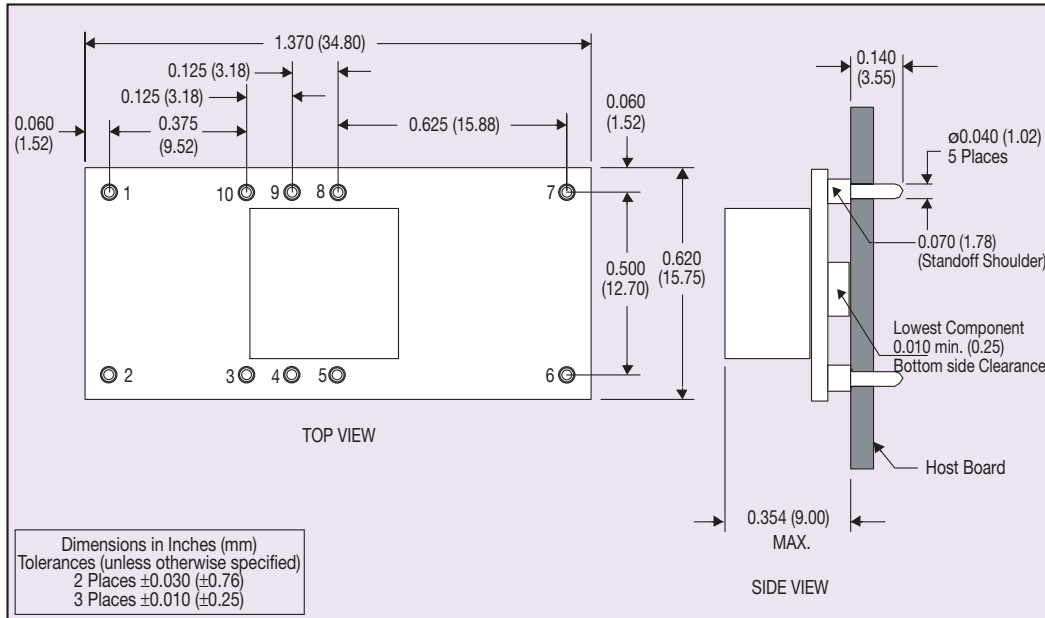

Figure 5 - Plated Through-Hole Mechanical Drawing

PIN CONNECTIONS	
PIN NO.	FUNCTION
1	Ground
2	Vin
3	Inhibit*
4	Vo adjust
5	Vo sense
6	Vout
7	Ground
8	Track
9	Margin down*
10	Margin up*

\*Denotes negative logic:  
Open = Normal operation  
Ground = Function active

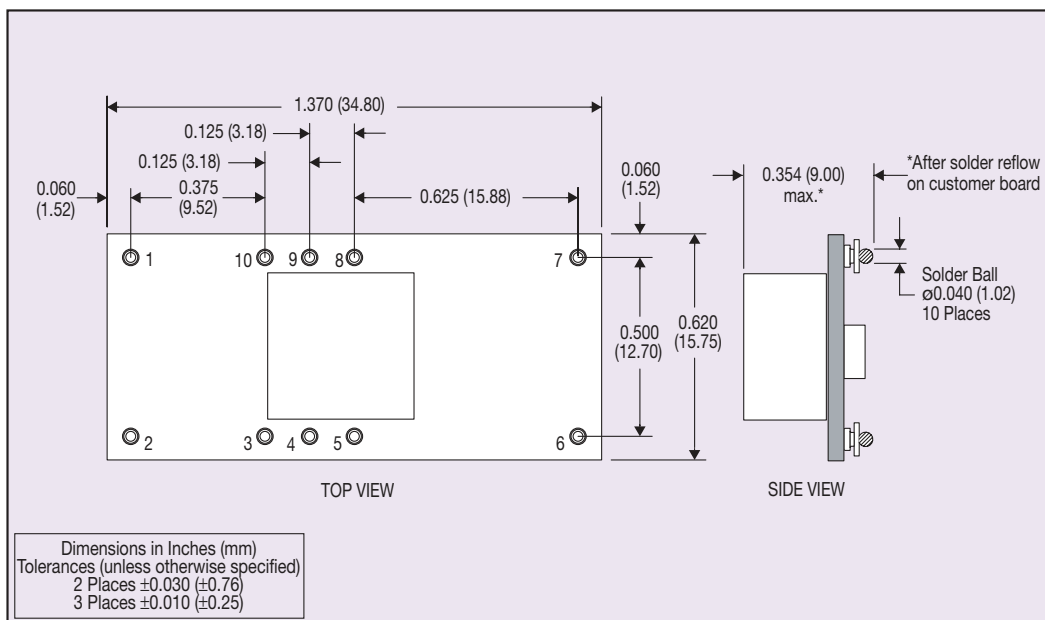

Figure 6 - Surface-Mount Mechanical Drawing