

MDE0420A400300BW	400 x 300	3-Wire SPI Interface	E-Ink Module
(MDE042A400300BW) Specification			
Version: 1		Date: 13/08/2018	
Revision			
1	08/01/2018	First Issue.	

Display Features		RoHS compliant
Display Size	4.2"	
Resolution	400 x 300	
Orientation	Landscape	
Appearance	Black, White	
Logic Voltage	3.3V	
Interface	SPI	
Touchscreen	N/A	
Module Size	91.00 x 77.00 x 1.25 mm	
Operating Temperature	0°C ~ +50°C	
Pinout	24 - Way FFC	Box Quantity
Pitch	0.5mm	Weight / Display

design • manufacture • supply

* - For full design functionality, please use this specification in conjunction with the SSD1619A specification.(Provided Separately)

Display Accessories	
Part Number	Description

Optional Variants	
Appearances	Voltage



General Description

MDE0420A400300BW is an Active Matrix Electrophoretic Display (AMEPD), with interface and a reference system design. The 4.2" active area contains 400×300 pixels, and has 1-bit B/W full display capabilities. An integrated circuit contains gate buffer, source buffer, interface, timing control logic, oscillator, DC-DC, SRAM, LUT, VCOM and border are supplied with each panel.

Features

- 400×300 pixels display
- White reflectance above 35%
- Contrast ratio above 10:1
- Ultra wide viewing angle
- Ultra low power consumption
- Pure reflective mode
- Bi-stable display
- Commercial temperature range
- Landscape, portrait modes
- Hard-coat antiglare display surface
- Ultra Low current deep sleep mode
- On chip display RAM
- Low voltage detect for supply voltage
- High voltage ready detect for driving voltage
- Internal temperature sensor
- 10-byte OTP space for module identification
- Serial peripheral interface available
- On-chip oscillator
- On-chip booster and regulator control for generating VCOM, Gate and Source driving voltage
- I2C signal master interface to read external temperature sensor/ built-in temperature sensor

Application

Electronic Shelf Label System

Mechanical Specifications

Parameter	Specifications	Unit	Remark
Screen Size	4.2	Inch	
Display Resolution	400(H)×300(V)	Pixel	Dpi:119
Active Area	84.8(H)×63.6 (V)	mm	
Pixel Pitch	0.212×0.212	mm	
Pixel Configuration	Square		
Outline Dimension	91.00(H)× 77.00(V) × 1.25(D)	mm	
Weight	15±0.2	g	



Mechanical Drawing of EPD module

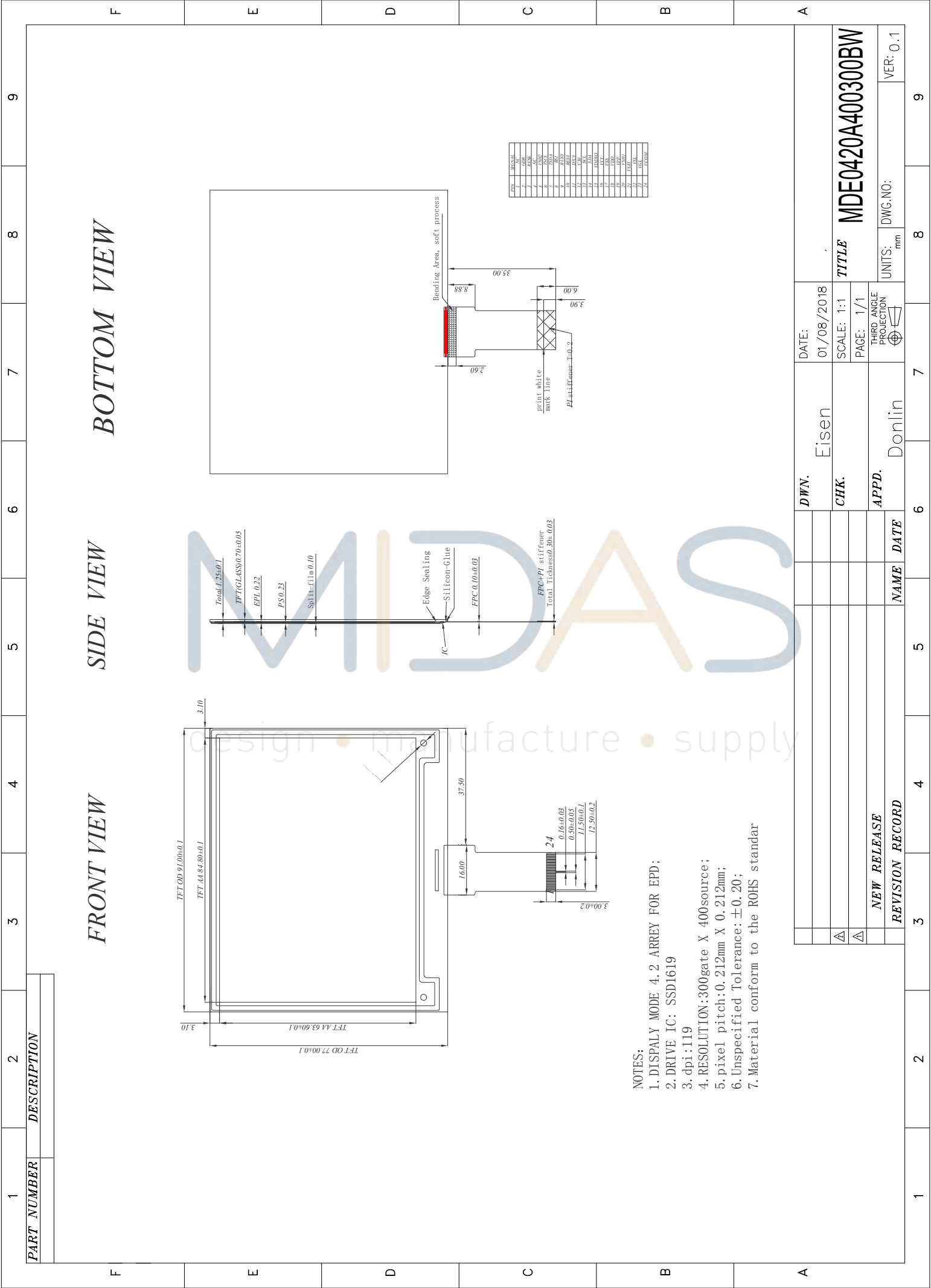

FRONT VIEW

SIDE VIEW

BOTTOM VIEW

- NOTES:**
1. DISPALY MODE 4.2 ARREY FOR EPD;
 2. DRIVE IC: SSD1619
 3. dpi:119
 4. RESOLUTION:300gate X 400source;
 5. pixel pitch:0.212mm X 0.212mm;
 6. Unspecified Tolerance: ±0.20;
 7. Material conform to the ROHS standar

DWN.	Eisen	DATE:	01/08/2018
CHK.		SCALE:	1:1
APPD.	Donin	PAGE:	1/1
NAME		THIRD ANGLE PROJECTION	
DATE		TITLE	MDE0420A400300BW
NEW RELEASE		UNITS:	mm
REVISION RECORD		DWG.NO:	
		VER:	0.1

1

2

3

4

5

6

7

8

9

F

E

D

C

B

A

9

8

7

6

5

4

3

2

1

PART NUMBER	DESCRIPTION
-------------	-------------

Input/Output Terminals

Pin #	Single	Description	Remark
1	NC	No connection and do not connect with other NC pins	NC Keep Open
2	GDR	N-Channel MOSFET Gate Drive Control	
3	RESE	Current Sense Input for the Control Loop	
4	NC	No connection and do not connect with other NC pins	Keep Open
5	VSH2	Positive Source driving voltage	
6	TSCL	I2C Interface to digital temperature sensor Clock pin	
7	TSDA	I2C Interface to digital temperature sensor Data pin	
8	BS1	Bus selection pin	Note 6-5
9	BUSY	Busy state output pin	Note 6-4
10	RES #	Reset	Note 6-3
11	D/C #	Data /Command control pin	Note 6-2
12	CS #	Chip Select input pin	Note 6-1
13	SCL	serial clock pin (SPI)	
14	SDA	serial data pin (SPI)	
15	VDDIO	Power for interface logic pins	
16	VCI	Power Supply pin for the chip	
17	VSS	Ground	
18	VDD	Core logic power pin	
19	VPP	Power Supply for OTP Programming	
20	VSH1	Positive Source driving voltage	
21	VGH	Power Supply pin for Positive Gate driving voltage and VSH	
22	VSL	Negative Source driving voltage	
23	VGL	Power Supply pin for Negative Gate driving voltage, VCOM and VSL	
24	VCOM	VCOM driving voltage	

Note 6-1: This pin (CS#) is the chip select input connecting to the MCU. The chip is enabled for MCU communication: only when CS# is pulled LOW.

Note 6-2: This pin (D/C#) is Data/Command control pin connecting to the MCU. When the pin is pulled HIGH, the data will be interpreted as data. When the pin is pulled set is active low.

Note 6-4: This pin (BUSY) is Busy state output pin. When Busy is High the operation of chip should not be interrupted and any commands should not be issued to the module. The driver IC will put Busy pin High when the driver IC is working such as:

- Outputting display waveform; or
- Communicating with digital temperature sensor

Note 6-5: This pin (BS1) is for 3-line SPI or 4-line SPI selection. When it is “Low”, 4-line SPI is selected. When it is “High”, 3-line SPI (9 bits SPI) is selected.

MCU Interface

1. MCU Interface selection

The SSD1619A can support 3-wire/4-wire serial peripheral. In the SSD1619A, the MCU interface is pin selectable by BS1 shown in Table7-1.

Note

- (1) L is connected to VSS
- (2) H is connected to VDDIO

Table 7-1 : Interface pins assignment under different MCU interface

MCU Interface	Pin Name					
	BS1	RES#	CS#	D/C#	SCL	SDA
4-wire serial peripheral interface (SPI)	Connect to VSS	Required	Required	Required	SCL	SDA
3-wire serial peripheral interface (SPI) – 9 bits SPI	Connect to VDDIO	Required	Required	Connect to VSS	SCL	SDA

2. MCU Serial Interface (4-wire SPI)

The 4-wire SPI consists of serial clock SCL, serial data SDA, D/C# and CS#. The control pins status in 4-wire SPI in writing command/data is shown in Table 7-2 and the write procedure 4-wire SPI is shown in Table 7-2

Table 7-2 : Control pins status of 4-wire SPI

Function	SCL pin	SDA pin	D/C# pin	CS# pin
Write command	↑	Command bit	L	L
Write data	↑	Data bit	H	L

Note:

- (1) L is connected to VSS and H is connected to VDDIO
- (2) ↑ stands for rising edge of signal
- (3) SDA(Write Mode) is shifted into an 8-bit shift register on each rising edge of SCL in the order of D7, D6, ... D0. The level of D/C# should be kept over the whole byte. The data byte in the shift register is written to the Graphic Display Data RAM (RAM)/Data Byte register or command Byte register according to D/C# pin.



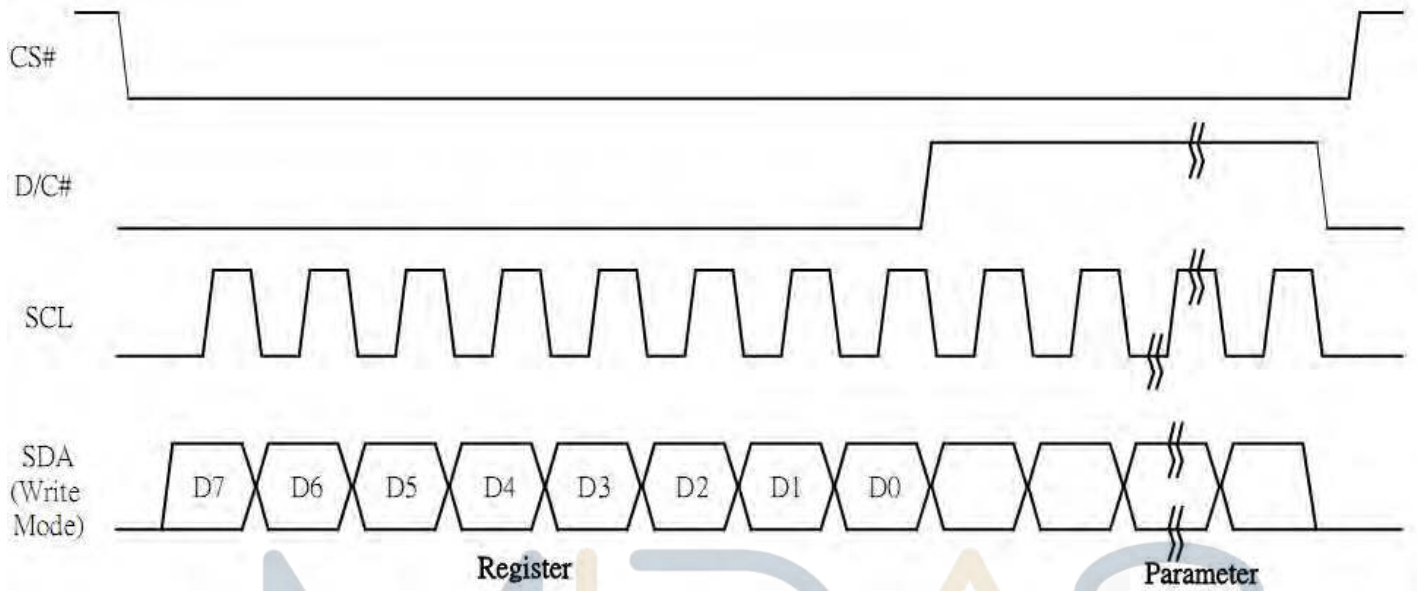

Figure 7-2 : Write procedure in 4-wire SPI mode

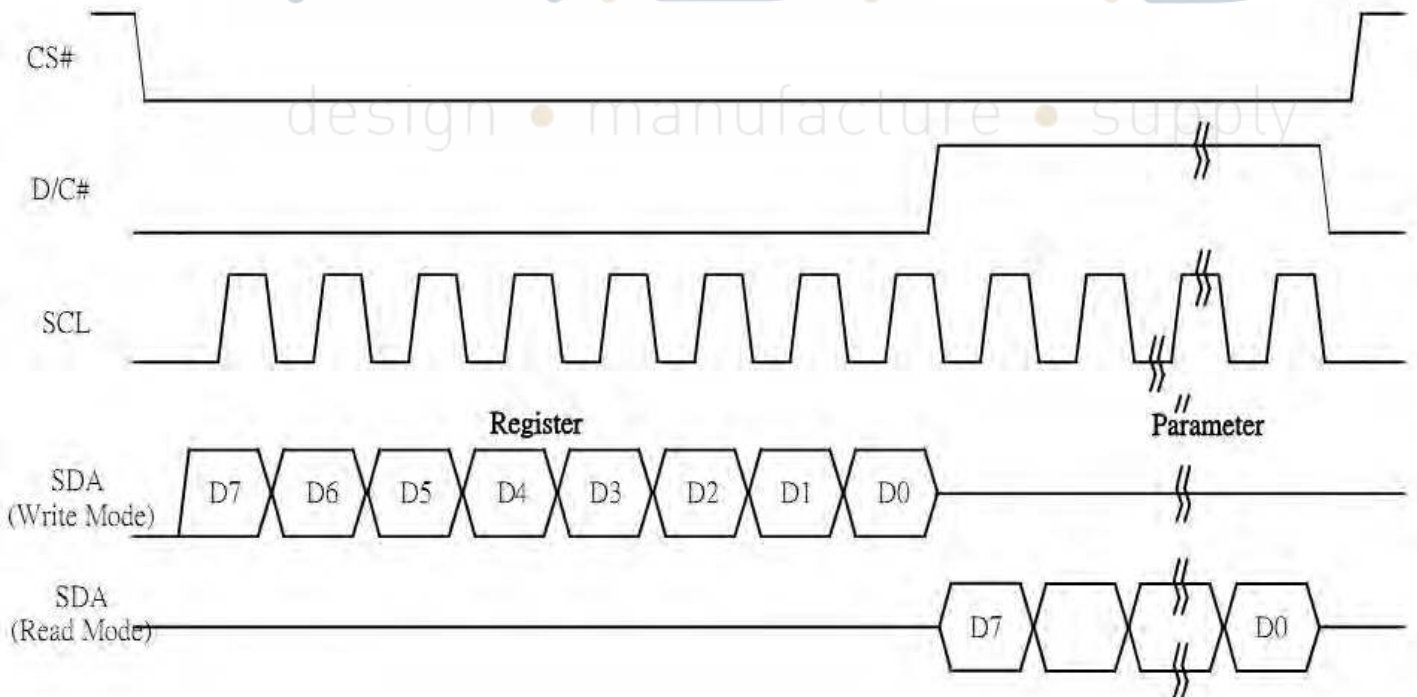

Figure 7-2 : Read procedure in 4-wire SPI mode



3. MCU Serial Peripheral Interface (3-wire SPI)

The 3-wire SPI consists of serial clock SCL, serial data SDA and CS#. The operation is similar to 4-wire SPI while D/C# pin is not used and it must be tied to LOW. The control pins status in 3-wire SPI is shown in Table 7-3. In the write operation, a 9-bit data will be shifted into the shift register on each clock rising edge. The bit shifting sequence is D/C# bit, D7 bit, D6 bit to D0 bit. The first bit is D/C# bit which determines the following byte is command or write data. When D/C# bit is 0, the following byte is command. When D/C# bit is 1, the following byte is data. Table 7-3 shows the write procedure in 3-wire SPI

Table 7-3 : Control pins status of 3-wire SPI

Function	SCL pin	SDA pin	D/C# pin	CS# pin
Write command	↑	Command bit	Tie LOW	L
Write data	↑	Data bit	Tie LOW	L

Note:

- (1) L is connected to VSS and H is connected to VDDIO
- (2) ↑ stands for rising edge of signal

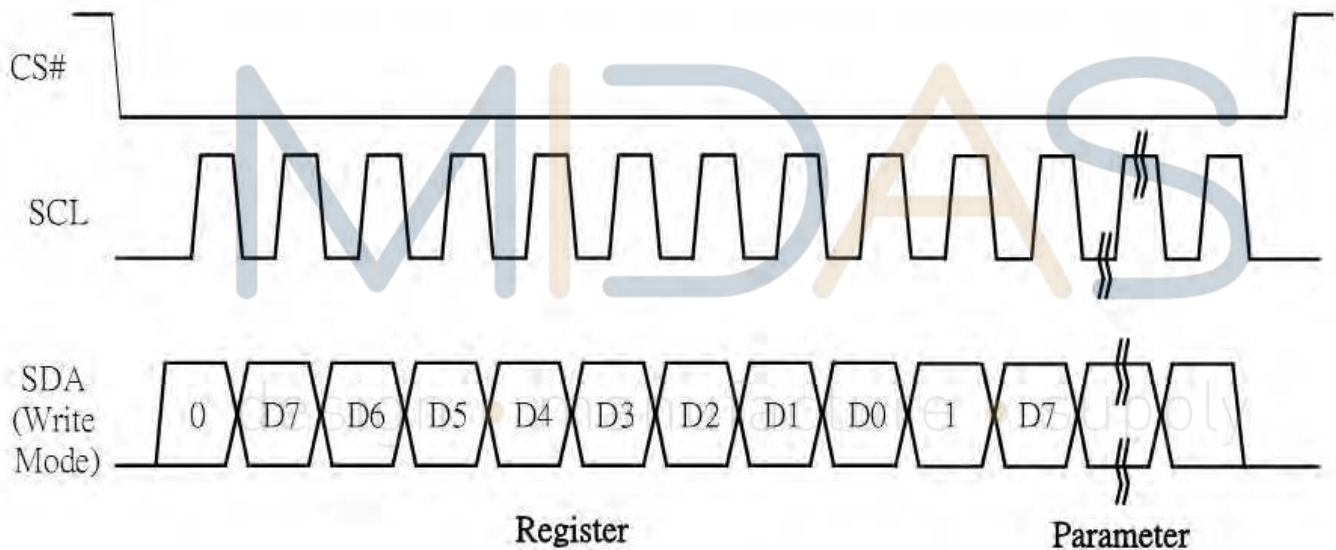

Figure 7-3 : Write procedure in 3-wire SPI



In the read operation (Register 0x1B, 0x27, 0x2D, 0x2E, 0x2F, 0x35), SDA data are transferred in the unit of 9 bits. After CS# pull low, the first byte is command byte, the D/C# bit is as 0 and following with the register byte. After command byte send, the following byte(s) are data byte(s), with D/C# bit is 1. After D/C# bit sending from MCU, an 8-bit data will be shifted out on each clock falling edge. The serial data SDA bit shifting sequence is D7, D6, to D0 bit. Figure 7-4 shows the read procedure in 3-wire SPI.

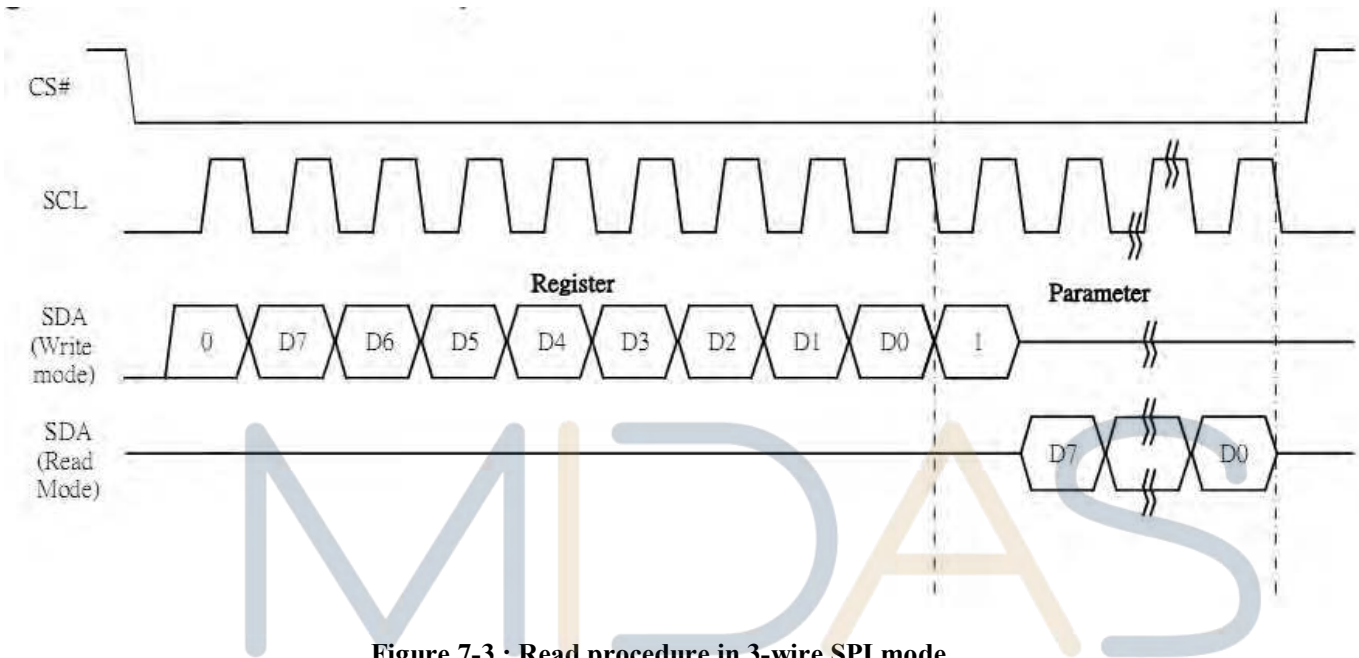

Figure 7-3 : Read procedure in 3-wire SPI mode

design • manufacture • supply



COMMAND TABLE

R/W#	D/C#	Hex	D7	D6	D5	D4	D3	D2	D1	D0	Command	Description								
0	0	01	0	0	0	0	0	0	0	1	Driver Output Control	Set the number of gate. Setting for 300 gates is: Set A[8:0] = 12Bh Set B[7:0] = 00h								
0	1	-	A7	A6	A5	A4	A3	A2	A1	A0										
0	1	-	0	0	0	0	0	0	0	A8										
0	1	-	0	0	0	0	0	B2	B1	B0										
0	0	03	0	0	0	0	0	0	1	1	Gate Driving Voltage Control	Set Gate driving voltage. A[4:0] = 15h [POR], VGH at 19V								
0	1	-	0	0	0	A4	A3	A2	A1	A0										
0	0	04	0	0	0	0	0	1	0	0	Source Driving voltage Control	Set Source output voltage. A[7:0] = 41h [POR], VSH1 at 15V B[7:0] = A8h [POR], VSH2 at 5V C[7:0] = 32h [POR], VSL at -15V								
0	1	-	A7	A6	A5	A4	A3	A2	A1	A0										
			B7	B6	B5	B4	B3	B2	B1	B0										
			C7	C6	C5	C4	C3	C2	C1	C0										
0	0	0C	0	0	0	0	1	1	0	0	Softstart Control	Set Softstart setting A[7:0] = 8Eh B[7:0] = 8Ch C[7:0] = 85h D[7:0] = 3Fh								
0	1	-	A7	A6	A5	A4	A3	A2	A1	A0										
			B7	B6	B5	B4	B3	B2	B1	B0										
			C7	C6	C5	C4	C3	C2	C1	C0										
			D7	D6	D5	D4	D3	D2	D1	D1										
0	0	10	0	0	0	1	0	0	0	0	Deep Sleep Mode	Deep Sleep mode Control <table border="1"> <thead> <tr> <th>A[1:0]</th> <th>Description</th> </tr> </thead> <tbody> <tr> <td>00</td> <td>Normal Mode [POR]</td> </tr> <tr> <td>01</td> <td>Enter Deep Sleep Mode1</td> </tr> <tr> <td>11</td> <td>Enter Deep Sleep Mode2</td> </tr> </tbody> </table>	A[1:0]	Description	00	Normal Mode [POR]	01	Enter Deep Sleep Mode1	11	Enter Deep Sleep Mode2
A[1:0]	Description																			
00	Normal Mode [POR]																			
01	Enter Deep Sleep Mode1																			
11	Enter Deep Sleep Mode2																			
0	1	-	0	0	0	0	0	0	A1	A0										
0	0	11	0	0	0	1	0	0	0	1	Data Entry mode setting	Define data entry sequence. A[2:0] = 3h [POR], A [1:0] = ID[1:0] Address automatic increment / decrement setting The setting of incrementing or decrementing of the address counter can be made independently in each upper and lower bit of the address. 00 – Y decrement, X decrement, 01 – Y decrement, X increment, 10 – Y increment, X decrement, 11 – Y increment, X increment [POR] A[2] = AM Set the direction in which the address counter is updated automatically after data is written to the RAM. When AM= 0, the address counter is updated in the X direction. [POR] When AM = 1, the address counter is updated in the Y direction.								
0	1	-	0	0	0	0	0	A2	A1	A0										
0	0	12	0	0	0	1	0	0	1	0	SW RESET	It resets the commands and parameters to their S/W Reset default values except R10h-Deep Sleep Mode During operation, BUSY pad will output high. Note: RAM are unaffected by this command.								
0	0	14	0	0	0	1	0	1	0	0	HV Ready Detection	HV ready detection The command required CLKEN=1 and ANALOGEN=1 Refer to Register 0x22 for detail. After this command initiated, HV Ready detection starts. BUSY pad will output high during detection. The detection result can be read from the Status Bit Read (Command 0x2F).								

R/W#	D/C#	Hex	D7	D6	D5	D4	D3	D2	D1	D0	Command	Description														
0 0	0 1	15	0 0	0 0	0 0	1 0	0 0	1 A2	0 A1	1 A0	VCI Detection	<p>A[2:0] = 100 [POR] , Detect level at 2.3V</p> <p>A[2:0] : VCI level Detect</p> <table border="1"> <thead> <tr> <th>A[2:0]</th> <th>VCI level</th> </tr> </thead> <tbody> <tr> <td>011</td> <td>2.2V</td> </tr> <tr> <td>100</td> <td>2.3V</td> </tr> <tr> <td>101</td> <td>2.4V</td> </tr> <tr> <td>110</td> <td>2.5V</td> </tr> <tr> <td>111</td> <td>2.6V</td> </tr> <tr> <td>Other</td> <td>NA</td> </tr> </tbody> </table> <p>The command required CLKEN=1 and ANALOGEN=1</p> <p>Refer to Register 0x22 for detail.</p> <p>After this command initiated, VCI detection starts.</p> <p>BUSY pad will output high during detection.</p> <p>The detection result can be read from the Status Bit Read (Command 0x2F).</p>	A[2:0]	VCI level	011	2.2V	100	2.3V	101	2.4V	110	2.5V	111	2.6V	Other	NA
A[2:0]	VCI level																									
011	2.2V																									
100	2.3V																									
101	2.4V																									
110	2.5V																									
111	2.6V																									
Other	NA																									
0 0	0 1	18 -	0 A7	0 A6	0 A5	1 A4	1 A3	0 A2	0 A1	0 A0	Temperature sensor control	<p>Temperature Sensor Selection</p> <p>A[7:0] = 48h [POR], external temperature sensor</p> <p>A[7:0] = 80h Internal temperature sensor</p>														
0 0	0 1	1A -	0 A11	0 A10	0 A9	1 A8	1 A7	0 A6	1 A5	0 A4	Temperature Sensor Control (Write to temperature register)	<p>Write to temperature register.</p> <p>A[11:0] = 7FFh [POR]</p>														
0 1	0 1	1B -	0 A11	0 A10	0 A9	1 A8	1 A7	0 A6	1 A5	1 A4	Temperature Sensor Control (Read from temperature register)	<p>Read from temperature register.</p>														
0	0	20	0	0	1	0	0	0	0	0	Master Activation	<p>Activate Display Update Sequence.</p> <p>The Display Update Sequence Option is located at R22h</p> <p>BUSY pad will output high during operation.</p> <p>User should not interrupt this operation to avoid corruption of panel images.</p>														
0 0	0 1	21 -	0 A7	0 A6	1 A5	0 A4	0 A3	0 A2	0 A1	1 A0	Display Update Control 1	<p>RAM content option for Display Update</p> <p>A[7:0] = 00h [POR]</p> <p>A[7:4] Red RAM option</p> <table border="1"> <tbody> <tr> <td>0000</td> <td>Normal</td> </tr> <tr> <td>0100</td> <td>Bypass RAM content as 0</td> </tr> <tr> <td>1000</td> <td>Inverse RAM content</td> </tr> </tbody> </table> <p>A[3:0] BW RAM option</p> <table border="1"> <tbody> <tr> <td>0000</td> <td>Normal</td> </tr> <tr> <td>0100</td> <td>Bypass RAM content as 0</td> </tr> <tr> <td>1000</td> <td>Inverse RAM content</td> </tr> </tbody> </table>	0000	Normal	0100	Bypass RAM content as 0	1000	Inverse RAM content	0000	Normal	0100	Bypass RAM content as 0	1000	Inverse RAM content		
0000	Normal																									
0100	Bypass RAM content as 0																									
1000	Inverse RAM content																									
0000	Normal																									
0100	Bypass RAM content as 0																									
1000	Inverse RAM content																									



R/W#	D/C#	Hex	D7	D6	D5	D4	D3	D2	D1	D0	Command	Description	
0	0	22	0	0	1	0	0	0	1	0	Display Update Control 2	Display Update Sequence Option: Enable the stage for Master Activation A[7:0]=FFh (POR)	
0	1	-	A7	A6	A5	A4	A3	A2	A1	A0			Parameter (in Hex)
												Enable Clock Signal, Then Enable Analog Then DISPLAY for display mode 1 Then Disable Analog Then Disable OSC	C7
												Load LUT from OTP Enable Clock Signal, Then Load LUT for display mode 1 Then Disable OSC	91
												Load TS and then Load LUT from OTP Enable Clock Signal, Then Load TS Then Load LUT for display mode 1 Then Disable OSC	B1
													Parameter (in Hex)
												Enable Clock Signal, Then Enable Analog Then DISPLAY for display mode 2 Then Disable Analog Then Disable OSC	CF
												Load LUT from OTP Enable Clock Signal, Then Load LUT for display mode 2 Then Disable OSC	99
												Load TS and then Load LUT from OTP Enable Clock Signal, Then Load TS Then Load LUT for display mode 2 Then Disable OSC	B9
0	0	24	0	0	1	0	0	1	0	0	Write RAM(BW)	After this command, data entries will be written into the RAM until another command is written. Address pointers will advance accordingly. For Write pixel: Content of Write RAM(BW)=1 For Black pixel: Content of Write RAM(BW)=0	
0	0	26	0	0	1	0	0	1	1	0	Write RAM(RED)	After this command, data entries will be written into the RED RAM until another command is written. Address pointers will advance accordingly. For Red pixel: Content of Write RAM(RED)=1 For non-Red pixel[Black or White]: Content of Write RAM(RED)=0	
0	0	27	0	0	1	0	0	1	1	1	Read RAM	After this command, data read on the MCU bus will fetch data from RAM [According to parameter of Register 41h to select reading RAM(BW) / RAM(RED)], until another command is written. Address pointers will advance accordingly. The 1st byte of data read is dummy data.	



R/W#	D/C#	Hex	D7	D6	D5	D4	D3	D2	D1	D0	Command	Description
0	0	2B	0	0	1	0	1	0	1	1	ACVCOM setting	Set following values when ACVCOM is used, it will not affect DCVCOM A[7:0] = 04h B[7:0] = 63h
0	1	-	A7	A6	A5	A4	A3	A2	A1	A0		
0	1	-	B7	B6	B5	B4	B3	B2	B1	B0		
0	0	2C	0	0	1	0	1	1	0	0	Write VCOM register	Write VCOM register from MCU interface A[7:0]=00h[POR]
0	1	-	A7	A6	A5	A4	A3	A2	A1	A0		
			A[7:0]	VCOM (V)			A[7:0]	VCOM (V)				
			08h	-0.2			44h	-1.7				
			0Bh	-0.3			48h	-1.8				
			10h	-0.4			4Bh	-1.9				
			14h	-0.5			50h	-2				
			17h	-0.6			54h	-2.1				
			1Bh	-0.7			58h	-2.2				
			20h	-0.8			5Bh	-2.3				
			24h	-0.9			5Fh	-2.4				
			28h	-1			64h	-2.5				
			2Ch	-1.1			68h	-2.6				
			2Fh	-1.2			6Ch	-2.7				
			34h	-1.3			6Fh	-2.8				
			37h	-1.4			73h	-2.9				
			3Ch	-1.5			78h	-3				
			40h	-1.6			Other	NA				
0	0	2D	0	0	1	0	1	1	0	1	OTP Register Read	Read Register stored in OTP: 1. A[7:0]~ B[7:0]: VCOM Information 2. C[7:0]~F[7:0]: Display Mode 3. G[7:0]~H[7:0]: Module ID/ Waveform Version [2bytes]
0	1		A7	A6	A5	A4	A3	A2	A1	A0		
0	1		H7	H6	H5	H4	H3	H2	H1	H0		
0	0	2E	0	0	1	0	1	1	1	0	User ID read	Read 10 Byte User ID stored in OTP: A[7:0]~J[7:0]: UserID (R38, Byte A and Byte J) [10 bytes]
0	1		A7	A6	A5	A4	A3	A2	A1	A0		
0	1		J7	J6	J5	J4	J3	J2	J1	J0		
0	0	2F	0	0	1	0	1	0	0	1	Status Bit Read	Read IC status Bit [POR 0x21] A[5]: HV Ready Detection flag [POR=1] 0: Ready 1: Not Ready A[4]: VCI Detection flag [POR=0] 0: Normal 1: VCI lower than the Detect level A[3]: [POR=0] A[2]: Busy flag [POR=0] 0: Normal 1: BUSY A[1:0]: Chip ID [POR=01] Remark: A[5] and A[4] status are not valid after RESET, they need to be initiated by command 0x14 and command 0x15 respectively.
1	1	-	0	0	0	A4	0	0	A1	A0		
0	1	-	0	0	0	0	A3	A2	A1	A0		



R/W#	D/C#	Hex	D7	D6	D5	D4	D3	D2	D1	D0	Command	Description																														
0	0	32	0	0	1	1	0	0	1	0	Write LUT register	Write LUT register from MCU interface [70 bytes] (excluding the analog setting and frame setting)																														
0	1	-	A7	A6	A5	A4	A3	A2	A1	A0																																
0	1	-	:	:	:	:	:	:	:	:																																
0	1	-																																
0	0	36	0	0	1	1	0	1	1	0																																
											Program OTP	Program OTP for User ID [R38h] The command required CLKEN=1. Refer to Register 0x22 for detail. BUSY pad will output high during operation																														
0	0	38	0	0	1	1	1	0	0	0	Write Register for User ID	Write Register for User ID A[7:0]~J[7:0]: UserID [10 bytes]																														
0	1	-	A7	A6	A5	A4	A3	A2	A1	A0																																
1	1		J7	J6	J5	J4	J3	J2	J1	J0																																
0	0	39	0	0	1	1	1	0	0	1	OTP program mode	OTP program mode A[1:0] = 11: for OTP programming Remark: User is required to EXACTLY follow the reference code sequences																														
0	1	-	0	0	0	0	0	0	A1	A0																																
0	0	3A	0	0	1	1	1	0	1	0	Set dummy line period	Set A[7:0] = 2Ch																														
0	1	-	0	A6	A5	A4	A3	A2	A1	A0																																
0	0	3B	0	0	1	1	1	0	1	1	Set Gate line width	Set A[3:0] = 0Ah																														
0	1	-	0	0	0	0	A3	A2	A1	A0																																
0	0	3C	0	0	1	1	1	1	0	0	Border Waveform Control	Select border waveform for VBD A [7:6] Select VBD <table border="1"> <tr> <td>A[7:6]</td> <td>Select VBD as</td> </tr> <tr> <td>00[POR]</td> <td>GS Transition Define A[1:0]</td> </tr> <tr> <td>01</td> <td>Fix Level Define A [5:4]</td> </tr> <tr> <td>10</td> <td>VCOM</td> </tr> <tr> <td>11</td> <td>HIZ</td> </tr> </table> A [5:4] Fix Level Setting for VBD <table border="1"> <tr> <td>A[5:4]</td> <td>VBD level</td> </tr> <tr> <td>00[POR]</td> <td>VSS</td> </tr> <tr> <td>01</td> <td>VSH1</td> </tr> <tr> <td>10</td> <td>VSL</td> </tr> <tr> <td>11</td> <td>VSH2</td> </tr> </table> A[1:0] GS Transition setting for VBD <table border="1"> <tr> <td>A[1:0]</td> <td>VBD Transition</td> </tr> <tr> <td>00 [POR]</td> <td>LUT0</td> </tr> <tr> <td>01</td> <td>LUT1</td> </tr> <tr> <td>10</td> <td>LUT2</td> </tr> <tr> <td>11</td> <td>LUT3</td> </tr> </table>	A[7:6]	Select VBD as	00[POR]	GS Transition Define A[1:0]	01	Fix Level Define A [5:4]	10	VCOM	11	HIZ	A[5:4]	VBD level	00[POR]	VSS	01	VSH1	10	VSL	11	VSH2	A[1:0]	VBD Transition	00 [POR]	LUT0	01	LUT1	10	LUT2	11	LUT3
A[7:6]	Select VBD as																																									
00[POR]	GS Transition Define A[1:0]																																									
01	Fix Level Define A [5:4]																																									
10	VCOM																																									
11	HIZ																																									
A[5:4]	VBD level																																									
00[POR]	VSS																																									
01	VSH1																																									
10	VSL																																									
11	VSH2																																									
A[1:0]	VBD Transition																																									
00 [POR]	LUT0																																									
01	LUT1																																									
10	LUT2																																									
11	LUT3																																									
0	1	-	A7	A6	A5	A4	0	0	A1	A0																																

R/W#	D/C#	Hex	D7	D6	D5	D4	D3	D2	D1	D0	Command	Description
0	0	41	0	1	0	0	0	0	1	0	Read RAM Option	Read RAM Option A[0]= 0 [POR] 0 : Read RAM corresponding to 24h 1 : Read RAM corresponding to 26h
0	1	-	0	0	0	0	0	0	0	A0		
0	0	44	0	1	0	0	0	1	0	0	Set RAM X - address Start / End position	Specify the start/end positions of the window address in the X direction by an address unit A[4:0] = 00h B[4:0] = 3 1h
0	1	-	0	0	0	A4	A3	A2	A1	A0		
0	0	45	0	1	0	0	0	1	0	1	Set Ram Y- address Start / End position	Specify the start/end positions of the window address in the Y direction by an address unit A[7:0] = 12Bh B[7:0] = 0000h
0	1	-	A7	A6	A5	A4	A3	A2	A1	A0		
0	1	-	0	0	0	0	0	0	0	A8		
0	1	-	B7	B6	B5	B4	B3	B2	B1	B0		
0	1	-	0	0	0	0	0	0	0	B8		
0	0	4E	0	1	0	0	1	1	1	0	Set RAM X - address counter	Make initial settings for the RAM X address in the address counter (AC) A[4:0] = 00h
0	1	-	0	0	0	A4	A3	A2	A1	A0		
0	0	4F	0	1	0	0	1	1	1	1	Set RAM Y - address counter	Make initial settings for the RAM Y address in the address counter (AC) A[8:0] = 12Bh
0	1	-	A7	A6	A5	A4	A3	A2	A1	A0		
			0	0	0	0	0	0	0	A8		
0	0	74	0	1	1	1	0	1	0	0	Set Analog Block control	A[7:0] = 54h
0	1		A7	A6	A5	A4	A3	A2	A1	A0		
0	0	7E	0	1	1	1	1	1	1	0	Set Digital Block control	A[7:0] = 3Bh
0	1		A7	A6	A5	A4	A3	A2	A1	A0		

design • manufacture • supply



Reference Circuit

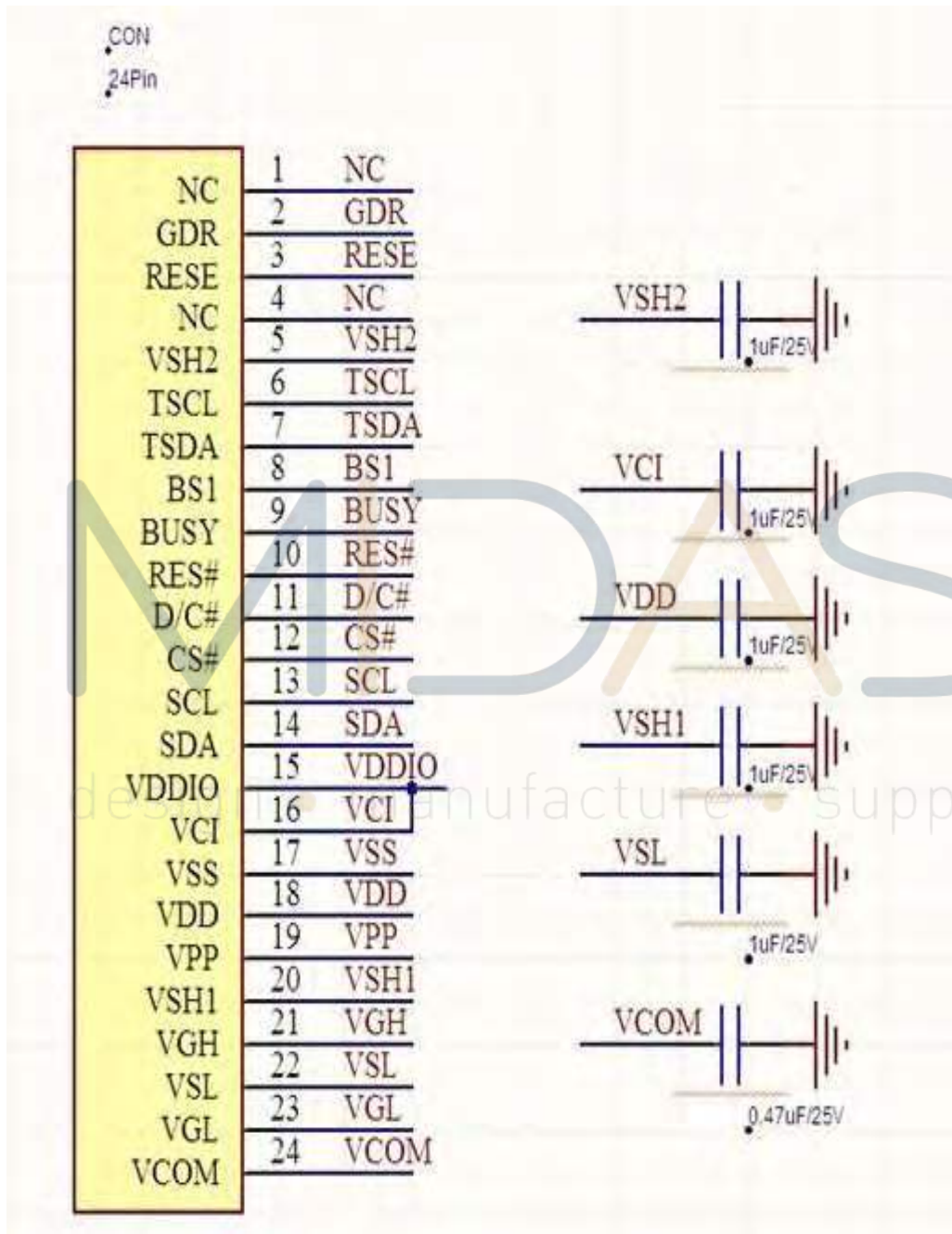

Figure. 9-1

Absolute Maximum Rating

Table 10-1 : Maximum Ratings

Symbol	Parameter	Rating	Unit
VCI	Logic supply voltage	-0.5 to +6.0	V
TOPR	Operation temperature range	0 to 50	°C
TSTG	Storage temperature range	-25 to 60	°C

DC CHARACTERISTICS

The following specifications apply for: VSS=0V, VCI=3.3V, T_{OPR}=25°C.

Table 11-1: DC Characteristics

Symbol	Parameter	Condition	Min.	Typ.	Max.	Unit
VCI	VCI operation voltage	-	2.2	3.3	3.7	V
VIH	High level input voltage	Digital input pins	0.8VDDIO	-	-	V
VIL	Low level input voltage	Digital input pins	-	-	0.2VDDIO	V
VOH	High level output voltage	IOH = -100uA	0.9VDDIO	-	-	V
VOL	Low level output voltage	IOL = 100uA	-	-	0.1VDDIO	V
Iupdate	Module operating current	-	-	7	-	mA
Isleep	Deep sleep mode	VCI=3.3V	-	0.73	-	uA

- The Typical power consumption is measured using associated 25°C waveform with following pattern transition: from horizontal scan pattern to vertical scan pattern. (Note 11-1)
- The listed electrical/optical characteristics are only guaranteed under the controller & waveform provided by Midas .

- Vcom value will be OTP before in factory or present on the label sticker.

Note 11-1

The Typical power consumption

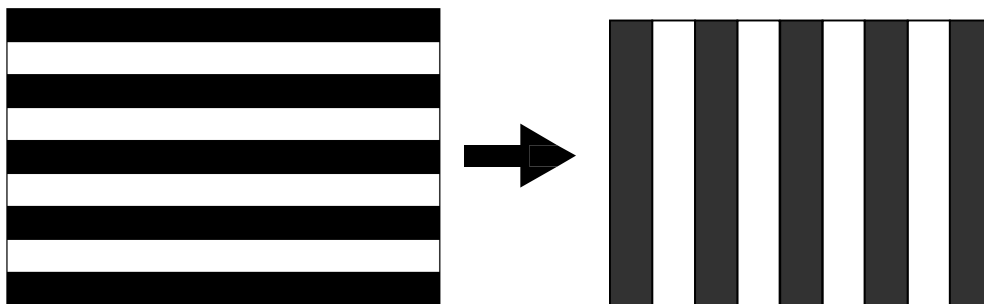

AC Characteristics

The following specifications apply for: VDDIO - VSS = 2.2V to 3.7V, TOPR = 25°C

Write mode

Symbol	Parameter	Min	Typ	Max	Unit
fSCL	SCL frequency (Write Mode)			20	MHz
tCSSU	Time CS# has to be low before the first rising edge of SCLK	20			ns
tCSHLD	Time CS# has to remain low after the last falling edge of SCLK	20			ns
tCSHIGH	Time CS# has to remain high between two transfers	100			ns
tSCLHIGH	Part of the clock period where SCL has to remain high	25			ns
tSCLLOW	Part of the clock period where SCL has to remain low	25			ns
tSISU	Time SI (SDA Write Mode) has to be stable before the next rising edge of SCL	10			ns
tSIHLD	Time SI (SDA Write Mode) has to remain stable after the rising edge of SCL	40			ns

Read mode

Symbol	Parameter	Min	Typ	Max	Unit
fSCL	SCL frequency (Read Mode)			2.5	MHz
tCSSU	Time CS# has to be low before the first rising edge of SCLK	100			ns
tCSHLD	Time CS# has to remain low after the last falling edge of SCLK	50			ns
tCSHIGH	Time CS# has to remain high between two transfers	250			ns
tSCLHIGH	Part of the clock period where SCL has to remain high	180			ns
tSCLLOW	Part of the clock period where SCL has to remain low	180			ns
tSOSU	Time SO (SDA Read Mode) will be stable before the next rising edge of SCL		50		ns
tSOHLD	Time SO (SDA Read Mode) will remain stable after the falling edge of SCL		0		ns

Note: All timings are based on 20% to 80% of VDDIO-VSS

Figure 12-2: SPI timing diagram

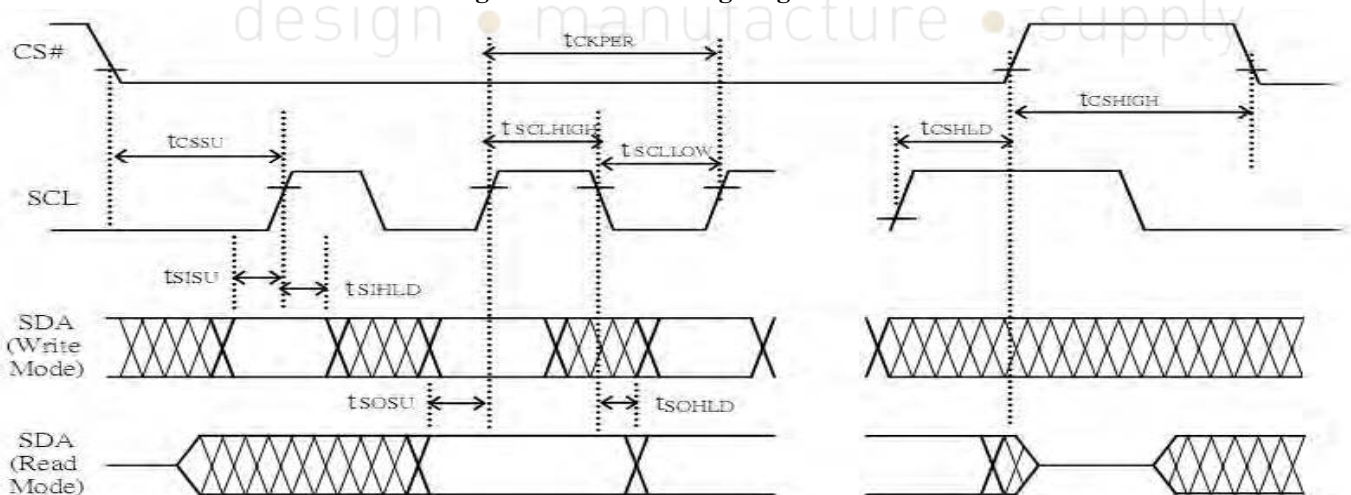

13. Power Consumption

Parameter	Symbol	Conditions	TYP	Max	Unit	Remark
Panel power consumption during update	-	25°C	25	-	mAs	-
Deep sleep mode	-	25°C	0.73	-	uA	-

Typical Operating Sequence

1. Normal Operation Flow

Sequence	Action by	Command	Action Description	Remark
1	User	-	Power on (VCI supply);	-
2	User	-	HW Reset	-
	IC	-	After HW reset, the IC will be ready for command input	-
	User	C 12	Command: SW Reset	--
	IC	-	After SW reset, the IC will have Registers load with POR value VCOM register loaded with OTP value IC enter idle mode	BUSY = H
	User	-	Wait until BUSY = L	-
3	-	-	Send initial code to driver including setting of	-
	User	C 74 D 54	Command: Set Analog Block Control	-
	User	C 7E D 3B	Command: Set Digital Block Control	-
	User	C 0C	Command: Set Softstart setting	-
	User	C 2B	Command: ACVCOM setting	-
	User	C 01	Command: Driver Output Control (MUX, Source gate scanning direction)	-
	User	C 3A	Command: Set dummy line period	-
	User	C 3B	Command: Set Gate line width	-
	User	C 3C	Command: Border waveform control	-
4	-	-	Data operations for Black White	-
	User	C 11	Command: Data Entry mode setting	-
	User	C 44	Command: RAM X address start /end position	-
	User	C 45	Command: RAM Y address start /end position	-
	User	C 4E	Command: RAM X address counter	-
	User	C 4F	Command: RAM Y address counter	-
	User	C 24	Command: write BW RAM	-
	-	-	Ram Content for Display	-
5	-	-	Data operations for RED	-
	User	C 11	Command: Data Entry mode setting	-
	User	C 44	Command: RAM X address start /end position	-
	User	C 45	Command: RAM Y address start /end position	-
	User	C 4E	Command: RAM X address counter	-
	User	C 4F	Command: RAM Y address counter	-
	User	C 26	Command: write RED RAM	-
	-	-	Ram Content for Display	-
6	User	C 22	Command: Display Update Control 2	BUSY=H
	User	C 20	Command: Master Activation	
	IC	-	Booster and regulators turn on	



	IC	-	Load LUT register with corresponding waveform setting stored in OTP)	
	IC	-	Send output waveform according RAM content and LUT.	
	IC	-	Booster and Regulators turn off	
	IC	-	Back to idle mode	
	User	-	Wait until BUSY = L	-
7	User	-	IC power off;	-

Optical characteristics

1. Specifications

Measurements are made with that the illumination is under an angle of 45 degrees, the detection is perpendicular unless otherwise specified.

T=25°C

SYMBOL	PARAMETER	CONDITIO NS	MIN	TYPE	MAX	UNIT	Note
R	Reflectance	White	30	35	-	%	Note 15-1
Gn	2Grey Level	-	-	$DS+(WS-DS) \times n(m-1)$	-	L*	-
CR	Contrast Ratio	indoor	-	10	-	-	-
Panel's life	-	0°C ~ 50°C		5years or 1000000 times	-	-	Note 15-2

WS: White state, DS : Dark state

m: 2

Note 15-1: Luminance meter : Eye - One Pro Spectrophotometer

Note 15-2: We guarantee display quality from 0°C ~ 30°C generally, If operation ambient temperature from 0°C ~ 50°C, will Offer special waveform by Midas.



2. Definition of contrast ratio

The contrast ratio (CR) is the ratio between the reflectance in a full white area (Rl) and the reflectance in a dark area (Rd):

$$CR = Rl/Rd$$

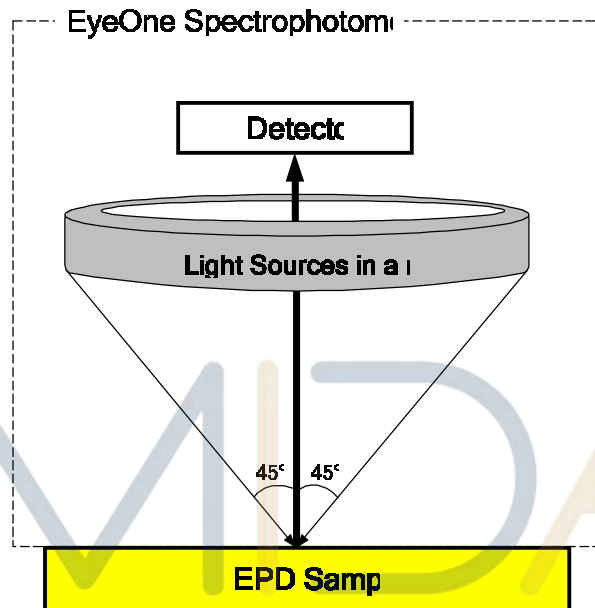

3. Reflection Ratio

The reflection ratio is expressed as:

$$R = \text{Reflectance Factor}_{\text{white board}} \times (L_{\text{center}} / L_{\text{white board}})$$

L_{center} is the luminance measured at center in a white area ($R=G=B=1$). $L_{\text{white board}}$ is the luminance of a standard white board. Both are measured with equivalent illumination source. The viewing angle shall be no more than 2 degrees.

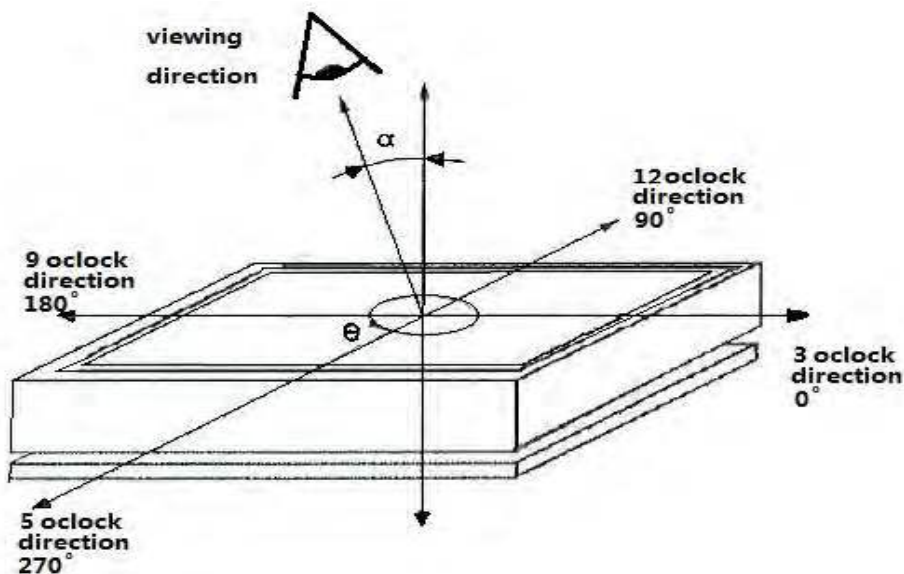

HANDLING, SAFETY AND ENVIROMENTAL REQUIREMENTS

WARNING

The display glass may break when it is dropped or bumped on a hard surface. Handle with care. Should the display break, do not touch the electrophoretic material. In case of contact with electrophoretic material, wash with water and soap.

CAUTION

The display module should not be exposed to harmful gases, such as acid and alkali gases, which corrode electronic components.

Disassembling the display module can cause permanent damage and invalidate the warranty agreements.

IPA solvent can only be applied on active area and the back of a glass. For the rest part, it is not allowed.

Observe general precautions that are common to handling delicate electronic components. The glass can break and front surfaces can easily be damaged. Moreover the display is sensitive to static electricity and other rough environmental conditions.

Mounting Precautions

(1) It's recommended that you consider the mounting structure so that uneven force (ex. Twisted stress) is not applied to the module.

(2) It's recommended that you attach a transparent protective plate to the surface in order to protect the EPD. Transparent protective plate should have sufficient strength in order to resist external force.

(3) You should adopt radiation structure to satisfy the temperature specification.

(4) Acetic acid type and chlorine type materials for the cover case are not desirable because the former generates corrosive gas of attacking the PS at high temperature and the latter causes circuit break by electro-chemical reaction.

(5) Do not touch, push or rub the exposed PS with glass, tweezers or anything harder than HB pencil lead. And please do not rub with dust clothes with chemical treatment. Do not touch the surface of PS for bare hand or greasy cloth. (Some cosmetics deteriorate the PS)

(6) When the surface becomes dusty, please wipe gently with absorbent cotton or other soft materials like chamois soaks with petroleum benzene. Normal-hexane is recommended for cleaning the adhesives used to attach the PS. Do not use acetone, toluene and alcohol because they cause chemical damage to the PS.

(7) Wipe off saliva or water drops as soon as possible. Their long time contact with PS causes deformations and color fading.

Product specification

The data sheet contains final product specifications.



Limiting values

Limiting values given are in accordance with the Absolute Maximum Rating System (IEC 134). Stress above one or more of the limiting values may cause permanent damage to the device. These are stress ratings only and operation of the device at these or any other conditions above those given in the Characteristics sections of the specification is not implied. Exposure to limiting values for extended periods may affect device reliability.
--

Application information

Where application information is given, it is advisory and does not form part of the specification.

Product Environmental certification
--

ROHS

REMARK

All The specifications listed in this document are guaranteed for module only. Post-assembled operation or component(s) may impact module performance or cause unexpected effect or damage and therefore listed specifications is not warranted after any Post-assembled operation.

MIDAS
design • manufacture • supply



Reliability test

	TEST	CONDITION	METHOD	REMARK
1	High-Temperature Operation	T=50°C , RH=30%RH, For 240Hr	IEC 60 068-2-2Bb	
2	Low-Temperature Operation	T = 0°C for 240 hrs	IEC 60 068-2-2Ab	
3	High-Temperature Storage	T=70°C RH=40%RH For 240Hr Test in white pattern	IEC 60 068-2-2Bb	
4	Low-Temperature Storage	T = -25°C for 240 hrs Test in white pattern	IEC 60 068-2-2Ab	
5	High Temperature, High-Humidity Operation	T=40°C , RH=90%RH, For 168Hr	IEC 60 068-2-3CA	
6	High Temperature, High-Humidity Storage	T=60°C , RH=80%RH, For 480Hr Test in white pattern	IEC 60 068-2-3CA	
7	Temperature Cycle	-25°C(30min)~70°C(30min) , 50 Cycle Test in white pattern	IEC 60 068-2-14NB	
8	Package Vibration	1.04G,Frequency : 10~500Hz Direction : X,Y,Z Duration: 1hours in each direction	Full packed for shipment	
9	Package Drop Impact	Drop from height of 122 cm on Concrete surface Drop sequence: 1 corner, 3edges, 6face One drop for each.	Full packed for shipment	
10	UV exposure Resistance	765 W/m ² for 168hrs,40°C	IEC 60068-2-5 Sa	
11	Electrostatic discharge	Machine model: +/-250V,0Ω,200pF	IEC61000-4-2	

Actual EMC level to be measured on customer application.

Note1: The protective film must be removed before temperature test.

Note2: Stay white pattern for storage and non-operation test.



PartA/PartB specification

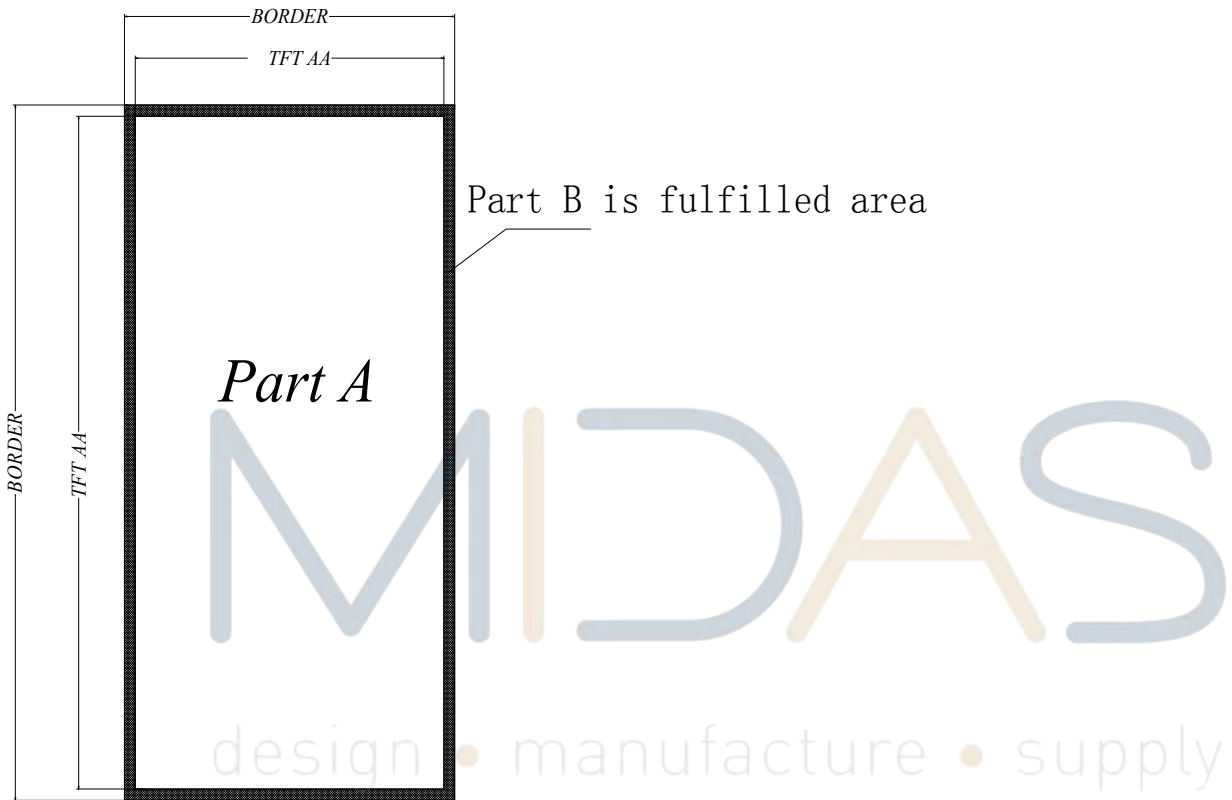

Point and line standard

Shipment Inspection Standard						
Equipment: Electrical test fixture, Point gauge						
Outline dimension	91 (H) × 77(V) × 1.25(D)	Unit: mm	Part-A	Active area	Part-B	Border area
Environment	Temperature	Humidity	Illuminance	Distance	Time	Angle
	19°C ~ 25°C	55% ± 5%RH	800 ~ 1300Lux	300 mm	35Sec	
Defet type	Inspection method	Standard		Part-A	Part-B	
Spot	Electric Display	D ≤ 0.25 mm		Ignore	Ignore	
		0.25 mm < D ≤ 0.4 mm		N ≤ 4	Ignore	
		0.40 mm < D ≤ 0.5 mm		N ≤ 1	Ignore	
		D > 0.5 mm		Not Allow	Ignore	
Display unwork	Electric Display	Not Allow		Not Allow	Ignore	
Display error	Electric Display	Not Allow		Not Allow	Ignore	
Scratch or line defect(include dirt)	Visual/Film card	L ≤ 2 mm, W ≤ 0.2 mm		Ignore	Ignore	
		2.0mm < L ≤ 8.0mm, 0.2 < W ≤ 0.5mm,		N ≤ 2	Ignore	
		L > 8.0 mm, W > 0.5 mm		Not Allow	Ignore	
PS Bubble	Visual/Film card	D ≤ 0.25mm		Ignore	Ignore	
		0.25mm ≤ D ≤ 0.40mm		N ≤ 4	Ignore	
		D > 0.40 mm		Not Allow	Ignore	
Side Fragment	Visual/Film card	X ≤ 6mm, Y ≤ 0.5mm, Do not affect the electrode circuit, Ignore				
						
Remark	1. Cannot be defect & failure cause by appearance defect;					
	2. Cannot be larger size cause by appearance defect;					
	L=long W=wide D=point size N=Defects NO					

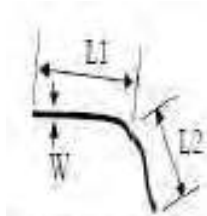

$$L = L1 + L2$$

Line Defect

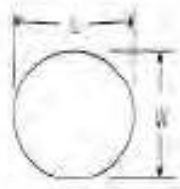

$$D = (L+W)/2$$

Spot Defect

L=long W=wide D=point size

MIDAS

design • manufacture • supply

