

**Full - Bridge  
Trench + Field Stop IGBT®  
Power Module**

**$V_{CES} = 600V$   
 $I_C = 20A @ T_c = 80^\circ C$**

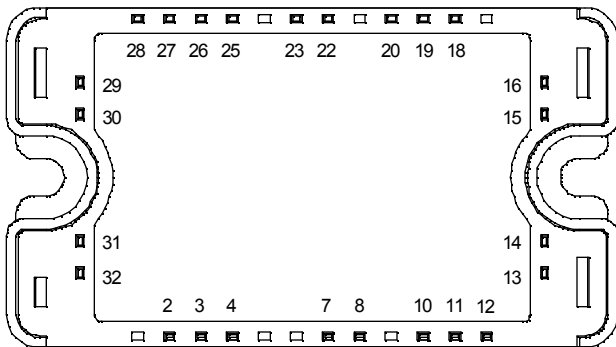
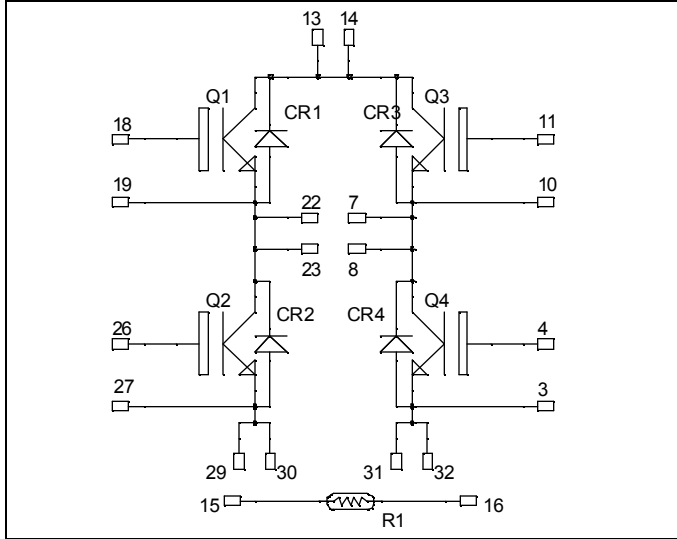

All multiple inputs and outputs must be shorted together  
 Example: 13/14 ; 29/30 ; 22/23 ...

### Application

- Welding converters
- Switched Mode Power Supplies
- Uninterruptible Power Supplies
- Motor control

### Features

- Trench + Field Stop IGBT® Technology
  - Low voltage drop
  - Low tail current
  - Switching frequency up to 20 kHz
  - Soft recovery parallel diodes
  - Low diode VF
  - Low leakage current
  - Avalanche energy rated
  - RBSOA and SCSOA rated
- Kelvin emitter for easy drive
- Very low stray inductance
  - Symmetrical design
- High level of integration
- Internal thermistor for temperature monitoring

### Benefits

- Stable temperature behavior
- Very rugged
- Solderable terminals for easy PCB mounting
- Direct mounting to heatsink (isolated package)
- Low junction to case thermal resistance
- Easy paralleling due to positive TC of VCEsat
- Low profile
- Each leg can be easily paralleled to achieve a phase leg of twice the current capability
- RoHS Compliant

### Absolute maximum ratings

Symbol	Parameter	Max ratings	Unit
$V_{CES}$	Collector - Emitter Breakdown Voltage	600	V
$I_C$	Continuous Collector Current	$T_C = 25^\circ C$	32
		$T_C = 80^\circ C$	20
$I_{CM}$	Pulsed Collector Current	$T_C = 25^\circ C$	40
$V_{GE}$	Gate - Emitter Voltage	$\pm 20$	V
$P_D$	Maximum Power Dissipation	$T_C = 25^\circ C$	62
RBSOA	Reverse Bias Safe Operating Area	$T_J = 150^\circ C$	40A @ 550V

**CAUTION:** These Devices are sensitive to Electrostatic Discharge. Proper Handling Procedures Should Be Followed. See application note APT0502 on [www.microsemi.com](http://www.microsemi.com)

All ratings @  $T_j = 25^\circ\text{C}$  unless otherwise specified

**Electrical Characteristics**

<i>Symbol</i>	<i>Characteristic</i>	<i>Test Conditions</i>	<i>Min</i>	<i>Typ</i>	<i>Max</i>	<i>Unit</i>
$I_{CES}$	Zero Gate Voltage Collector Current	$V_{GE} = 0V, V_{CE} = 600V$			250	$\mu\text{A}$
$V_{CE(sat)}$	Collector Emitter Saturation Voltage	$V_{GE} = 15V$ $I_C = 20A$	$T_j = 25^\circ\text{C}$	1.5	1.9	V
			$T_j = 150^\circ\text{C}$	1.7		
$V_{GE(th)}$	Gate Threshold Voltage	$V_{GE} = V_{CE}, I_C = 300\mu\text{A}$	5.0	5.8	6.5	V
$I_{GES}$	Gate – Emitter Leakage Current	$V_{GE} = 20V, V_{CE} = 0V$			300	nA

**Dynamic Characteristics**

<i>Symbol</i>	<i>Characteristic</i>	<i>Test Conditions</i>	<i>Min</i>	<i>Typ</i>	<i>Max</i>	<i>Unit</i>
$C_{ies}$	Input Capacitance	$V_{GE} = 0V$		1100		pF
$C_{oes}$	Output Capacitance	$V_{CE} = 25V$		70		
$C_{res}$	Reverse Transfer Capacitance	$f = 1\text{MHz}$		35		
$T_{d(on)}$	Turn-on Delay Time	Inductive Switching ( $25^\circ\text{C}$ ) $V_{GE} = \pm 15V$ $V_{Bus} = 300V$ $I_C = 20A$ $R_G = 12\Omega$		110		ns
$T_r$	Rise Time			45		
$T_{d(off)}$	Turn-off Delay Time			200		
$T_f$	Fall Time			40		
$T_{d(on)}$	Turn-on Delay Time	Inductive Switching ( $150^\circ\text{C}$ ) $V_{GE} = \pm 15V$ $V_{Bus} = 300V$ $I_C = 20A$ $R_G = 12\Omega$		120		ns
$T_r$	Rise Time			50		
$T_{d(off)}$	Turn-off Delay Time			250		
$T_f$	Fall Time			60		
$E_{on}$	Turn-on Switching Energy	$V_{GE} = \pm 15V$ $V_{Bus} = 300V$ $I_C = 20A$	$T_j = 25^\circ\text{C}$	0.11		mJ
			$T_j = 150^\circ\text{C}$	0.2		
$E_{off}$	Turn-off Switching Energy	$R_G = 12\Omega$	$T_j = 25^\circ\text{C}$	0.5		mJ
			$T_j = 150^\circ\text{C}$	0.7		

**Reverse diode ratings and characteristics**

<i>Symbol</i>	<i>Characteristic</i>	<i>Test Conditions</i>	<i>Min</i>	<i>Typ</i>	<i>Max</i>	<i>Unit</i>
$V_{RRM}$	Maximum Peak Repetitive Reverse Voltage		600			V
$I_{RM}$	Maximum Reverse Leakage Current	$V_R = 600V$	$T_j = 25^\circ\text{C}$		100	$\mu\text{A}$
			$T_j = 150^\circ\text{C}$		350	
$I_F$	DC Forward Current		$T_c = 80^\circ\text{C}$	20		A
$V_F$	Diode Forward Voltage	$I_F = 20A$ $V_{GE} = 0V$	$T_j = 25^\circ\text{C}$	1.6	2	V
			$T_j = 150^\circ\text{C}$	1.5		
$t_{rr}$	Reverse Recovery Time	$I_F = 20A$ $V_R = 300V$ $di/dt = 1600A/\mu\text{s}$	$T_j = 25^\circ\text{C}$	100		ns
			$T_j = 150^\circ\text{C}$	150		
$Q_{rr}$	Reverse Recovery Charge		$T_j = 25^\circ\text{C}$	1.1		$\mu\text{C}$
			$T_j = 150^\circ\text{C}$	2.3		
$E_r$	Reverse Recovery Energy		$T_j = 25^\circ\text{C}$	0.23		mJ
			$T_j = 150^\circ\text{C}$	0.50		

**Temperature sensor NTC** (see application note APT0406 on [www.microsemi.com](http://www.microsemi.com) for more information).

Symbol	Characteristic	Min	Typ	Max	Unit
R <sub>25</sub>	Resistance @ 25°C		50		kΩ
B <sub>25/85</sub>	T <sub>25</sub> = 298.15 K		3952		K

$$R_T = \frac{R_{25}}{\exp\left[B_{25/85}\left(\frac{1}{T_{25}} - \frac{1}{T}\right)\right]}$$

T: Thermistor temperature  
 R<sub>T</sub>: Thermistor value at T

## Thermal and package characteristics

Symbol	Characteristic	Min	Typ	Max	Unit		
R <sub>thJC</sub>	Junction to Case Thermal Resistance	IGBT		2.4	°C/W		
		Diode		3.25			
V <sub>ISOL</sub>	RMS Isolation Voltage, any terminal to case t=1 min, I <sub>isol</sub> <1mA, 50/60Hz	2500			V		
T <sub>J</sub>	Operating junction temperature range	-40		175	°C		
T <sub>STG</sub>	Storage Temperature Range	-40		125			
T <sub>C</sub>	Operating Case Temperature	-40		100			
Torque	Mounting torque		To heatsink	M4	2.5	4.7	N.m
Wt	Package Weight					110	g

## SP3 Package outline (dimensions in mm)

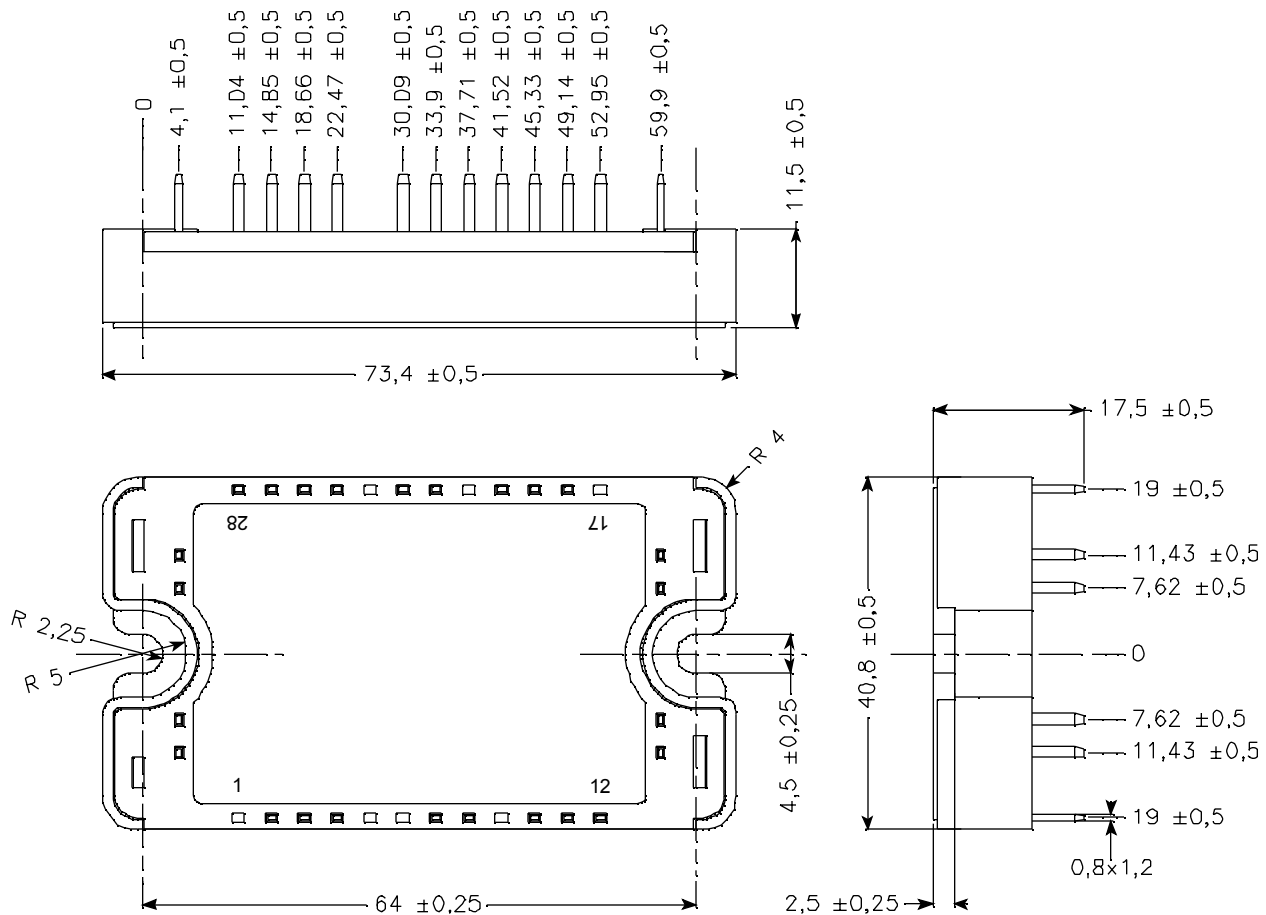

See application note 1901 - Mounting Instructions for SP3 Power Modules on [www.microsemi.com](http://www.microsemi.com)

## Typical Performance Curve

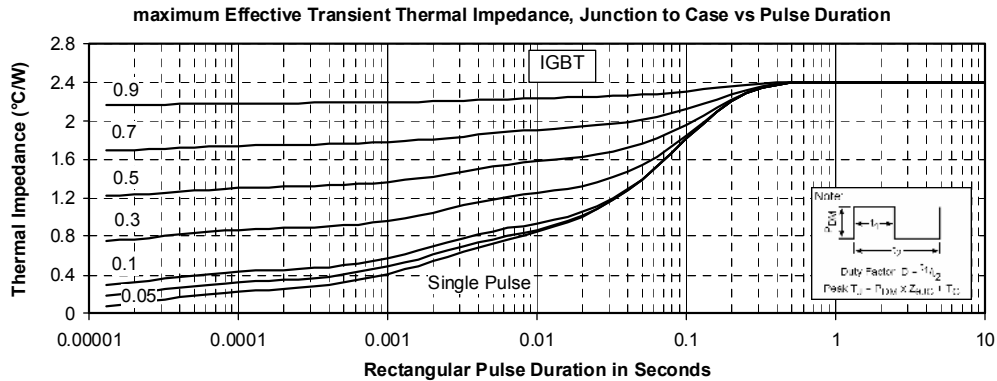
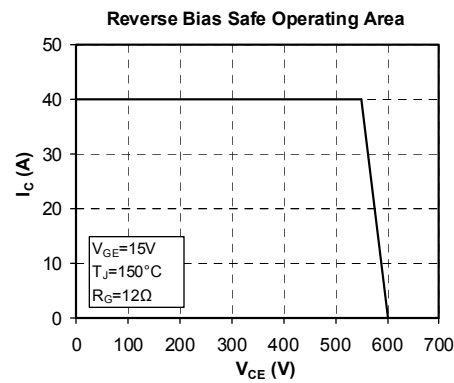
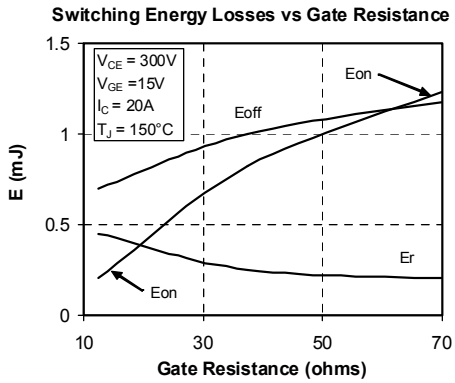
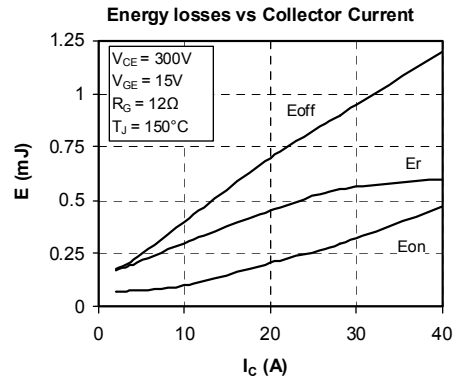
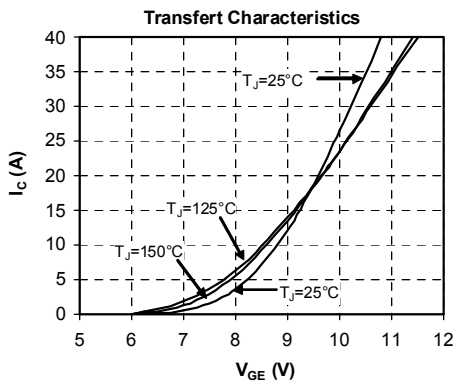
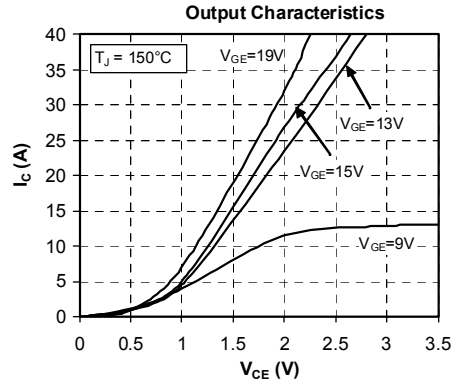
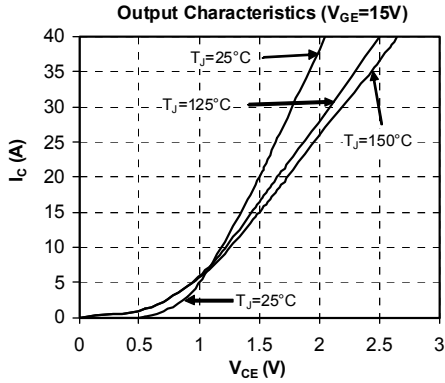

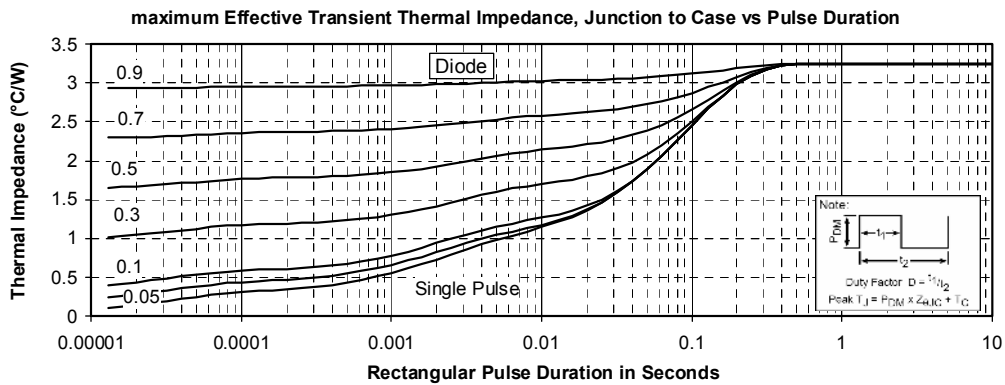
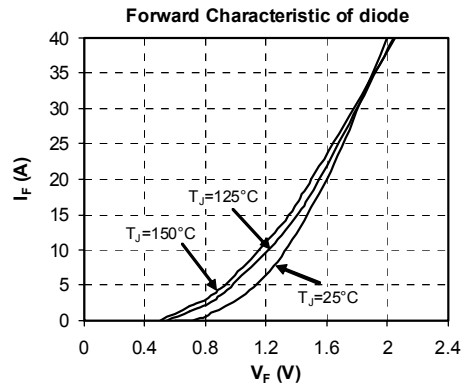
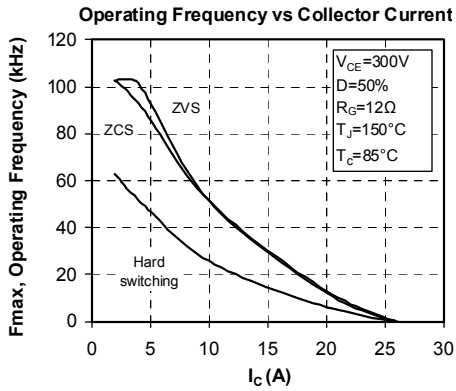

Microsemi reserves the right to change, without notice, the specifications and information contained herein

Microsemi's products are covered by one or more of U.S. patents 4,895,810 5,045,903 5,089,434 5,182,234 5,019,522 5,262,336 6,503,786 5,256,583 4,748,103 5,283,202 5,231,474 5,434,095 5,528,058 and foreign patents. U.S. and Foreign patents pending. All Rights Reserved.