



Part Number: D3I2060

Electrical Specifications

Frequency Range (GHz):	2.0 – 6.0
Isolation (dB):	14 MIN
Insertion Loss (dB):	0.8 MAX
VSWR:	1.5:1 MIN
Forward Power (W):	20 AVG 30 PK
Reflective Power (W):	2 AVG

Mechanical/Environmental Specifications

Connector Type:	SMA
Connector Body:	Passivated stainless steel
Connector Pin:	Gold plated copper
Load Body:	Brass
Magnetic Shunt:	Nickel plated CRS
Operational Temp:	0°C to +50°C
Weight (oz)	3.5 MAX

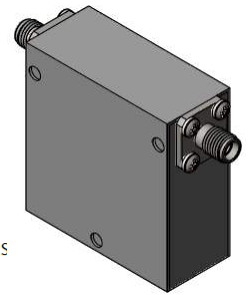

D3I2060 Dimensions

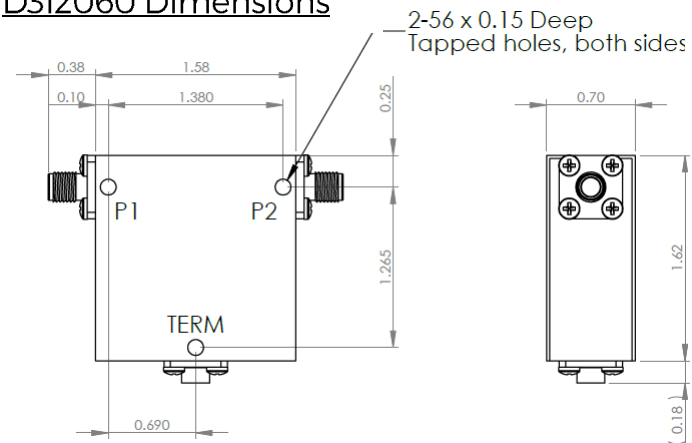

D3I2060-3 Dimensions

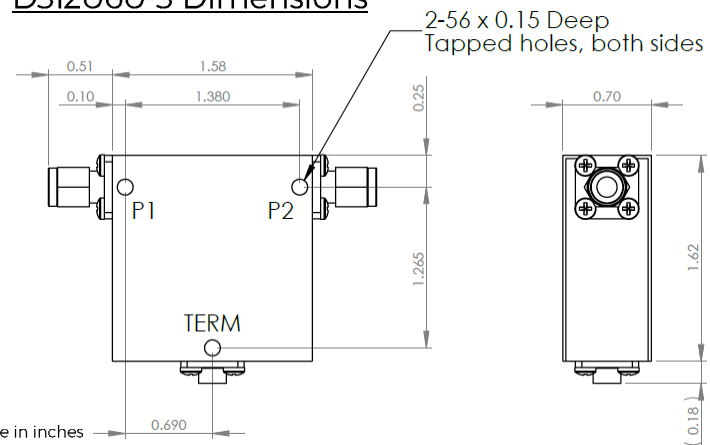

Dimensions are in inches
Tolerance

XX ±0.03
XXX ±0.010

Type of Device	PN Suffix	Connector Configuration Input / Output	PN Example
Single and Dual Junction Isolator, 2-Port Device Input / Output	N/A	Female / Female	D3I2060
	-1	Male / Female	D3I2060-1
	-2	Female / Male	D3I2060-2
	-3	Male / Male	D3I2060-3



MEASURED DATA

Part Number: D3I2060, +25°C

