



# Panasonic

ideas for life

## FOR PC BOARD TO FLAT CABLE MIL CONNECTORS (AXM)

Density mounting

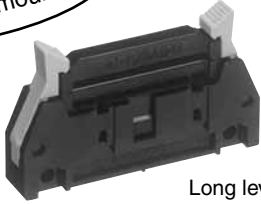

Long lever type

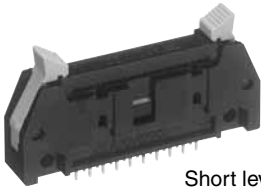

Short lever type

### FEATURES

**1. High density mounting is possible.**  
Even with mounting right next to another connector, insertion into and removal from the socket can be done, providing a saving in the surface mounting space.



**2. Lever with original stopper construction for great strength**  
The original stopper construction reduces the possibility of lever damage even when excess load is applied to the lever during socket insertion and removal, and during transportation.

**3. Metal pin-less lever construction**  
Noise prevention is considered in this construction by not using metal pins, which, if present, act as noise absorbing antennas.

**4. Incorrect insertion prevention mechanism.**  
Because of the box type construction of the header and the special key that is used, incorrect insertion can be prevented. Also, by means of the special key that is used, incorrect insertion into an adjacent connector is prevented.



Compliance with RoHS Directive

## ORDERING INFORMATION

### 1. Socket

AXM 1 [ ] [ ] [ ] 1 5

1: MIL connectors (Socket)

<No. of contacts (2 digits)>  
10: 10 contacts    14: 14 contacts    16: 16 contacts    20: 20 contacts    26: 26 contacts    30: 30 contacts  
34: 34 contacts    40: 40 contacts    50: 50 contacts    60: 60 contacts    64: 64 contacts

<Strain relief/Polarity guide>  
0: Without strain relief/10 contacts: with polarity guide  
2: Without strain relief/Min. 14 contacts with polarity guide, 10 contacts without polarity guide  
4: With strain relief/14 contacts with polarity guide, 10 contacts without polarity guide  
9: With strain relief/10 contacts: with polarity guide

<Pitch of flat cable>  
1: 1.27 mm

<Surface treatment (Contact portion/Terminal portion)>  
5: Au plating/Au plating

### 2. Header

AXM 2 [ ] [ ] [ ] [ ] 1

2: MIL connectors (Header)

<No. of contacts (2 digits)>  
10: 10 contacts    14: 14 contacts    16: 16 contacts    20: 20 contacts    26: 26 contacts    30: 30 contacts  
34: 34 contacts    40: 40 contacts    50: 50 contacts    60: 60 contacts    64: 64 contacts

<Lever shape>  
0: Long lever  
1: Short lever  
2: Without lever

<Terminal shape/Polarity slot>  
0: Straight (Min. 14 contacts with polarity slot, 10 contacts without polarity slot)  
1: Angle (Min. 14 contacts with polarity slot, 10 contacts without polarity slot)  
8: Straight (10 contacts with polarity slot)  
9: Angle (10 contacts with polarity slot)

<Surface treatment (Contact portion/Terminal portion)>  
1: Au plating/Sn plating

**3. Strain relief**

AXM

3

3: MIL connectors (Strain relief)

&lt;No. of contacts (2 digits)&gt;

10: 10 contacts   14: 14 contacts   16: 16 contacts   20: 20 contacts   26: 26 contacts   30: 30 contacts  
 34: 34 contacts   40: 40 contacts   50: 50 contacts   60: 60 contacts   64: 64 contacts

**SPECIFICATIONS****1. Characteristics**

Item		Specifications	Conditions
Electrical characteristics	Rated current	1 A When the header is connected to our wire-press socket, the rated current varies depending on the wire used as shown below. (AWG#23/#24: 3 A, AWG#26: 2 A, AWG#28: 1 A)	
	Breakdown voltage	750 V AC for 1 min.	Detection current: 1 mA
	Insulation resistance	Min. 1000MΩ	at 500V DC megger
	Contact resistance	Max. 20mΩ	Measured based on the HP4338B measurement method of JIS C 5402
Mechanical characteristics	Unit removal force	Min. 0.785N {80gf}/2 contacts	Measured by steel-pin-gauge with (0.64±0.01) × (0.64±0.01)mm <sup>2</sup> cross section area.
	Composite insertion force	Max. 2.94N {300gf} × no. of contacts	
	Post holding force	Min. 19.6N {2kgf}	By pulling post until coming off
	Lever locking strength	Min. 78.5N {8kgf}	Sockets are pulled to the derrection of shaft in the mated condition
	Cover strength	Min. 78.5N {8kgf}	By pulling protector or strain relief to the direction of shaft
Lifetime characteristics	Insertion and removal life	500 times	
	Ambient temperature	-55° to +105°C	
Environmental characteristics	Vibration resistance	10 to 55Hz at the double amplitude of 1.52mm	No opening more than 1μsec. at max. 100mA carrying current
	Shock resistance	490m/s <sup>2</sup> {50G}	No opening more than 1μsec. at max. 100mA carrying current

**2. Materials and surface treatment**

Part name	Material	Surface
Molded portion	Glass reinforced PBT (UL94V-0)	—
Contact (Socket)	Copper alloy	Contact portion: Ni plating on base, Au plating on surface Pressured portion: Ni plating on base, Au plating on surface
Post (Header)	Copper alloy	Contact portion: Ni plating on base, Au plating on surface Terminal portion: Ni plating on base, Sn plating on surface

**3. Applicable cable**

Standard wire	AWG28 Pitch 1.27mm
---------------	--------------------

**PRODUCT TYPES****1. Socket**

No. of contacts	No. of polarity guide	Without strain relief	With strain relief
10	0	AXM110215	AXM110415
	1	AXM110015	AXM110915
14	1	AXM114215	AXM114415
16	1	AXM116215	AXM116415
20	1	AXM120215	AXM120415
26	1	AXM126215	AXM126415
30	1	AXM130215	AXM130415
34	1	AXM134215	AXM134415
40	1	AXM140215	AXM140415
50	1	AXM150215	AXM150415
60	1	AXM160215	AXM160415
64	1	AXM164215	AXM164415

**2. Strain relief**

No. of contacts	Part No.
10	AXM310
14	AXM314
16	AXM316
20	AXM320
26	AXM326
30	AXM330
34	AXM334
40	AXM340
50	AXM350
60	AXM360
64	AXM364



3. Header

No. of contacts	No. of polarity slot	Long lever type		Short lever type	
		Angle	Straight	Angle	Straight
10	0	AXM210011	AXM210001	AXM210111	AXM210101
	1	AXM210091	AXM210081	AXM210191	AXM210181
14	1	AXM214011	AXM214001	AXM214111	AXM214101
16	1	AXM216011	AXM216001	AXM216111	AXM216101
20	1	AXM220011	AXM220001	AXM220111	AXM220101
26	1	AXM226011	AXM226001	AXM226111	AXM226101
30	1	AXM230011	AXM230001	AXM230111	AXM230101
34	1	AXM234011	AXM234001	AXM234111	AXM234101
40	1	AXM240011	AXM240001	AXM240111	AXM240101
50	1	AXM250011	AXM250001	AXM250111	AXM250101
60	1	AXM260011	AXM260001	AXM260111	AXM260101
64	1	AXM264011	AXM264001	AXM264111	AXM264101

Notes) 1. A no-lever type is available. This product will be manufactured after receiving your order. Please inquire about delivery.

When ordering change the fourth digit in the part number to "2".

2. The tray packing quantity for outer carton is 200 pcs.

3. For the available foreign standard products, refer to "STANDARDS CHART" on the end of the catalog.

4. Keys

Product name	Part No.
Polarity key	AXM8001
Incorrect insertion prevention key	AXM8002

DIMENSIONS (Unit: mm)

The CAD data of the products with a **CAD Data** mark can be downloaded from: <http://panasonic-electric-works.net/ac>

• Socket

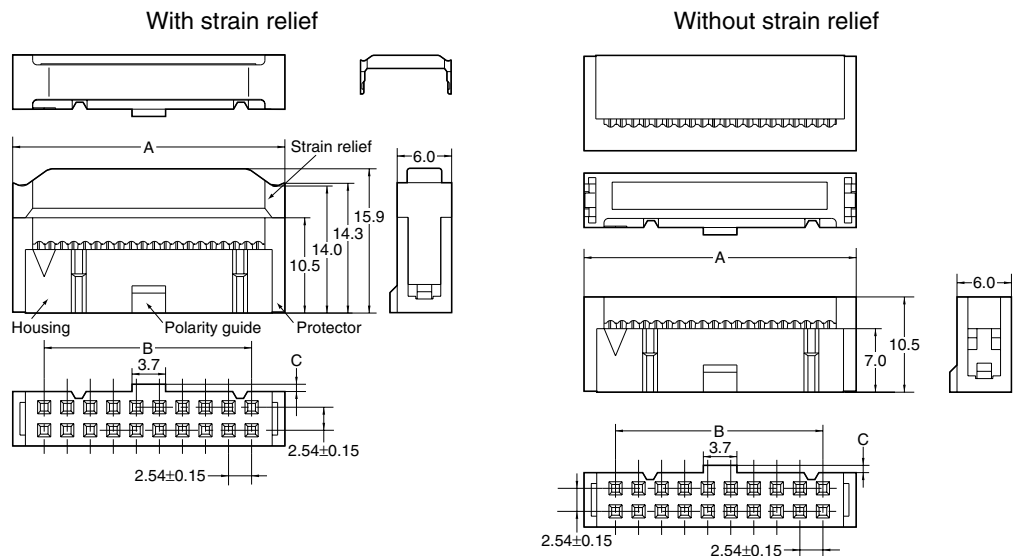

Dimension table (mm)

No. of contacts	No. of Polarity slot	A	B	C
10	0	17.3	10.16	—
	1	17.3	10.16	—
14	1	22.4	15.24	0.8
16	1	24.9	17.78	
20	1	30.0	22.86	1.0
26	1	37.6	30.48	
30	1	42.7	35.56	1.4
34	1	47.8	40.64	
40	1	55.4	48.26	1.4
50	1	68.1	60.96	
60	1	80.8	73.66	1.4
64	1	85.9	78.74	

Cross section view

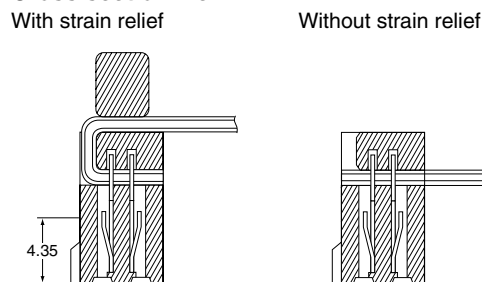

General tolerance: ±0.3



Discontinued as of September 30, 2010

AXM

• Header (Long lever type)

CAD Data

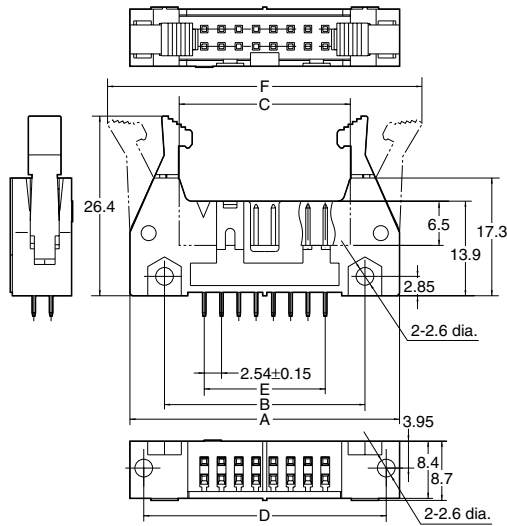

General tolerance: ±0.3

Dimension table (mm)

No. of contacts	No. of Polarity slot	A	B	C	D	E	F
10	0	32.0	21.84	17.53	27.9	10.16	38.6
	1	32.0	21.84	17.53	27.9	10.16	38.6
14	1	37.1	26.92	22.61	33.0	15.24	43.7
16	1	39.6	29.46	25.15	35.6	17.78	46.2
20	1	44.7	34.54	30.23	40.6	22.86	51.3
26	1	52.3	42.16	37.85	48.3	30.48	58.9
30	1	57.4	47.24	42.93	53.34	35.56	64.0
34	1	62.5	52.32	48.01	58.4	40.64	69.1
40	1	70.1	59.94	55.63	66.0	48.26	76.7
50	1	82.8	72.64	68.33	78.7	60.96	89.4
60	1	95.5	85.34	81.03	91.4	73.66	102.1
64	1	100.6	90.42	86.11	96.5	78.74	107.2

Terminal dimensions

Angle terminal      Straight terminal

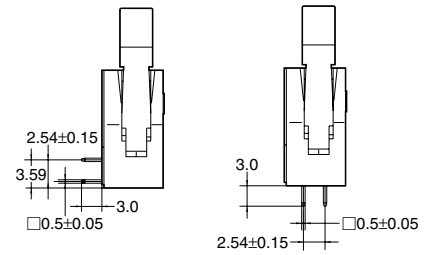

Recommended PC board pattern (BOTTOM VIEW)

Angle terminal

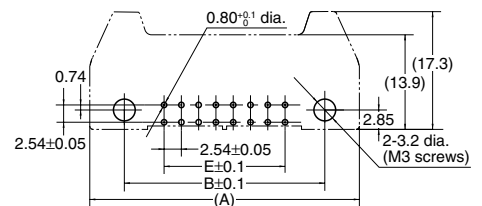

Straight terminal

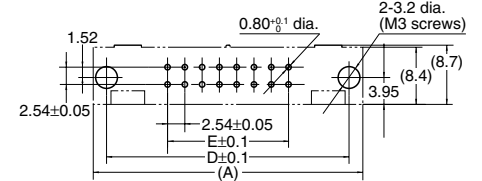

Note) Dimensions of A, B, D and E are the same as the header dimensions.

• Header [Short lever]

CAD Data

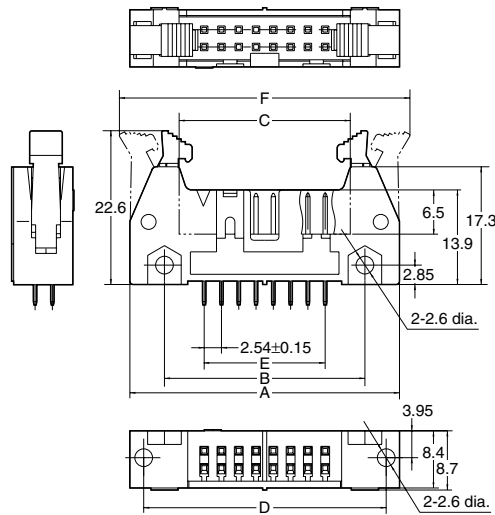
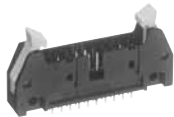

General tolerance: ±0.3

Dimension table (mm)

No. of contacts	No. of Polarity slot	A	B	C	D	E	F
10	0	32.0	21.84	17.53	27.9	10.16	35.0
	1	32.0	21.84	17.53	27.9	10.16	35.0
14	1	37.1	26.92	22.61	33.0	15.24	40.1
16	1	39.6	29.46	25.15	35.6	17.78	42.7
20	1	44.7	34.54	30.23	40.6	22.86	47.7
26	1	52.3	42.16	37.85	48.3	30.48	55.4
30	1	57.4	47.24	42.93	53.34	35.56	60.4
34	1	62.5	52.32	48.01	58.4	40.64	65.5
40	1	70.1	59.94	55.63	66.0	48.26	73.1
50	1	82.8	72.64	68.33	78.7	60.96	85.8
60	1	95.5	85.34	81.03	91.4	73.66	98.5
64	1	100.6	90.42	86.11	96.5	78.74	103.6

Terminal dimensions

Angle terminal      Straight terminal

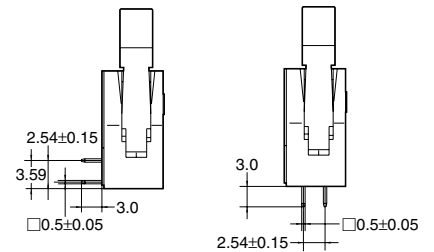

Recommended PC board pattern (BOTTOM VIEW)

Angle terminal

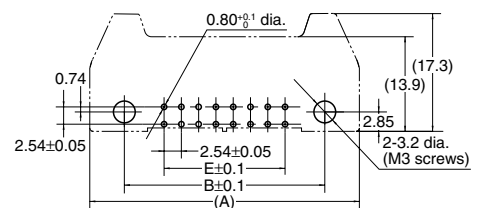

Straight terminal

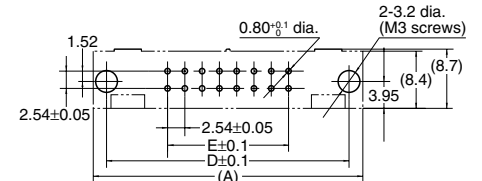

Note) Dimensions of A, B, D and E are the same as the header dimensions.



## CABLE NO. AND TERMINAL POSITION CORRELATION DRAWING

Socket

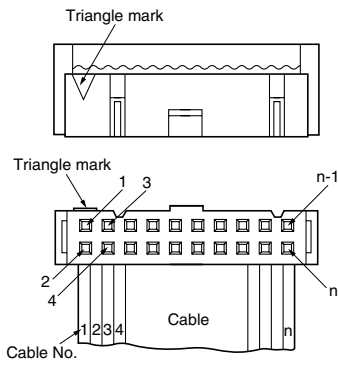

Header (Angle terminal)

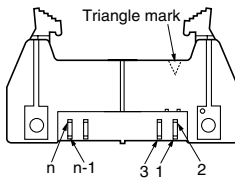

Header (Straight terminal)

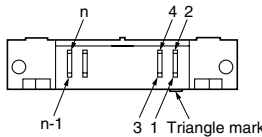

Terminal numbers are not indicated on the connector. Using the triangle mark as reference, the connection operations and printed circuit board design should be carried out.

When the cable numbers are temporarily assigned from the end as 1, 2, 3, 4 ... n, the corresponding terminal number positions for the socket are as shown in the drawing on the left. The header terminal positions and corresponding positions are shown in the drawing on the left.

## COMBINATION OF HEADER AND SOCKET

With strain relief

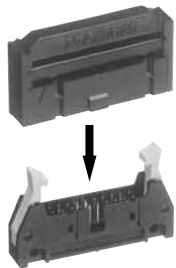

Long lever type

Without strain relief

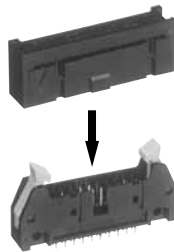

Short lever type

	Header	Long lever type	Short lever type
Socket			
Strain relief		Good	Not good
Without strain relief		Not good	Good

## REGARDING REVERSE AND INCORRECT INSERTION PREVENTION

### 1. Reverse insertion prevention mechanism

The header polarity slot and socket polarity guide of these MIL connectors make for a construction which prevents reverse insertion. (However, the 10-contact type does not feature this construction.)

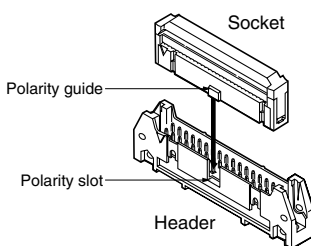

### 2. Polarity key (AXM8001) for double prevention of reverse insertion

Reverse insertion is doubly prevented by inserting the polarity key (AXM8001) into the header to create a projection and by aligning this projection with the cutout in the socket.

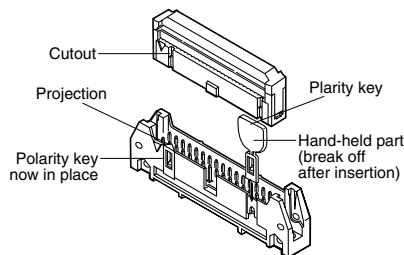

### 3. Incorrect insertion prevention key (AXM8002) ideal for preventing incorrect insertion into adjacent connectors when a multiple number of MIL connectors with the same number of contacts are used

Incorrect insertion is prevented by plugging the hole in the socket with the incorrect insertion prevention key (AXM8002) and then by removing or cutting off the pin of the corresponding header.

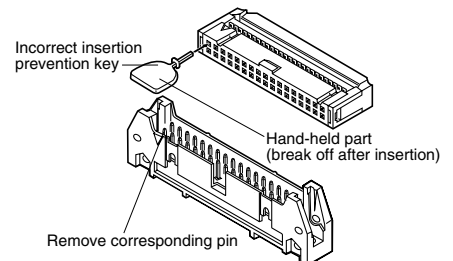



## NOTES

### 1. Regarding design of printed circuit board

The connector terminal numbers are not indicated. Using the triangle mark as reference, the printed circuit board design and the cable connection operations can be carried out.

### 2. Regarding insertion into and removal from the socket

When inserting or removing the connector, be careful not to pull the cable. Hold the socket by hand to remove the connector when the no-lever type is used. With the lever type header, removal is easy.

When the socket is unconnected, be careful not to apply excessive force to the levers.

### 3. Regarding external force applied to the cable

When there is the possibility that external force may be applied to the cable, or in the case of vibration being applied to the connector cable, a strain relief socket should be used.

### 4. Regarding soldering of the header

Soldering should be carried out under the conditions given below.

260°C: Within 10 seconds

300°C: Within 5 seconds

350°C: Within 3 seconds

### 5. Regarding the handling of header terminals

Care should be taken with the header terminals because repeated bending of the terminals can lead to damage.

### 6. Regarding the cable pressure connection tool

The special tool provided by our company for cutting the cable and making the pressure connections should be used.

### 7. Regarding the selection of header type

When making the selection of the header, the following factors should be used for the selection.

Condition Header	Repeated vibration and shock	Occasional vibration and shock	Force used on cable
Long lever type	Very good	Very good	Very good
Short lever type	Good	Good	Not good

Note) Vibration: 9.8 m/s<sup>2</sup> {1G}/10 to 150 Hz

Shock: 49 m/s<sup>2</sup> {5G}

The above should be considered as criteria.

For other details, please verify with the product specification sheets.



Discontinued as of September 30, 2010

AXY

# Panasonic

ideas for life

## TOOLS FOR FLAT CABLE CONNECTOR

## FLAT CABLE CONNECTOR TOOLS (AXY)

### CABLE CUTTER

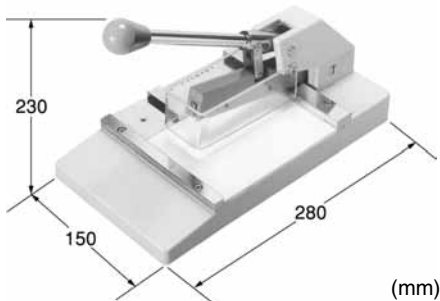

Compliance with RoHS Directive

### FEATURES

1. Flat cable (from 10 to 64 contacts) can be cut.
2. Accurate cutting only by setting cable to the guide.
3. Cutting knife can be fixed by clammer from the side and exchanged easily.
4. Safety cover for cutting knife is equipment.
5. The replacement blade of a commercially available box cutter can be used as the cable cutter blade.

### PRODUCT TYPES

Product name	Part No.
Cable cutter	AXY80000

### NOTES

- 1. Setting of flat cable**  
First, set the guide plate at the correct width. Then fix the cable and cut it.
- 2. Exchange of cutting knife**  
Push to attach the knife to the stopper pin of cutter holder and then set it.
- 3. Safety cover**  
Cutting work should be done with safety cover set. Please do not put your hand inside of safety cover set.
- 4. Do not remodel this product or use it for other purposes.**

### PRESSURE WELDING UNIT

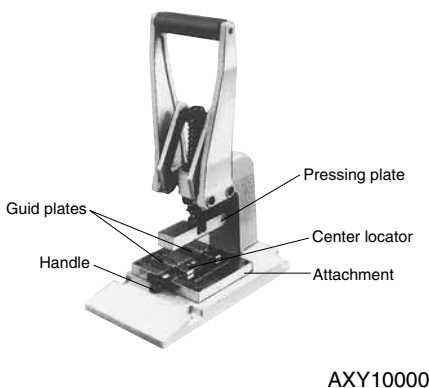

Compliance with RoHS Directive

### FEATURES

- 1. Operation without worry of connectors becoming damaged**  
When pressure welding, the connector will not break even if pressed too hard because the guide plate acts as a stopper.
- 2. Easy operation**  
Designed with the operator in mind, pressure welding is sure and easy with minimal force needed when operating the lever. It is also well suited to repetitive operation.
- 3. Using the same unit, all types of connectors can be pressure welded by simply replacing center locator and guide plate.**

- 4. Pressure welding of 10 to 64 strand cable is easily accomplished by changing the position of the guide plate.**
- 5. Positioning of the connector and cable is easily accomplished with the guide plate.**
- 6. After pressure welding a flat cable, the connector can be easily removed by pressing the handle to pop it out.**
- 7. Even if the connector type changes, the cover is always face down and pressure welding is always possible. Cables will never be displaced during pressure welding.**

### PRODUCT TYPES

Products name	Part No.	Remarks	
Pressure welding unit	AXY10000		
Accessories	Attachment	AXY20101 MIL and PCB types, Cable pitch 1.27mm	
	Center locator	AXY20201	MIL type
		AXY20202	PCB Mini-dip type
		AXY20203	PCB IC type, Terminal row pitch 7.62mm
		AXY20205	PCB IC type, Terminal row pitch 15.24mm
	Guide plate	AXY20301	MIL type
		AXY20302	PCB Mini-dip type
		AXY20303	PCB IC type, Terminal row pitch 7.62mm
	Spacer	AXY20305	PCB IC type, Terminal row pitch 15.24mm
		AXY20401	Mini-dip type, Terminal row pitch 2.54mm, 30 to 64 contacts
AXY20404		IC type, Terminal row pitch 15.24mm, 24 to 40 contacts	
AXY20405		Mini-dip type, Terminal row pitch 2.54mm, 10 to 26 contacts	
	AXY20406	IC type, Terminal row pitch 7.62mm, 14 to 20 contacts	

Note) The pressure welding unit is not include the accessories.



## COMBINATION OF ACCESSORIES

Applicable socket	No. of contacts	Attachment	Center locator	Guide plate	Spacer
MIL type	Every type	AXY20101	AXY20201	AXY20301	—
PCB (Mini-dip type)	10 to 26		AXY20202	AXY20302	AXY20405
	30 to 64		AXY20203	AXY20303	AXY20401
PCB (IC type)	14 to 20		AXY20205	AXY20305	AXY20406
	24 to 40				AXY20404

## SAFETY NOTES

**1. Do not do the following dangerous actions when using the pressure welder.**

- Insert hand or fingers beneath the pressure plate when operating the lever.
- Allow your fingers to get close to moving parts when operating the lever.
- Let go of the lever when in progress after pressure welding a connector. (Be sure to keep your hand on the lever all the way to the end. Otherwise the lever might snap back with considerable force.)

**2. Secure the pressure welder to the work bench to prevent it from falling over. Also, do not apply excessive force to the lever when pressure welding (such as by applying the full weight of your body).**

## PRESSING PLATE OF PRESSURE WELDING UNIT

1. The pressing plate consists of the pressing plate main unit and MIL/PCB type connector plate.

2. Proceed with the pressure connection of MIL type connectors (AXM1 series) and PCB type connectors (AXP series) with the MIL/PCB connector plate attached to the pressing plate main unit. Use the hexagonal head bolt to mount and remove the MIL/PCB type connector plate.

When pressure-welding MIL/PCB type connectors

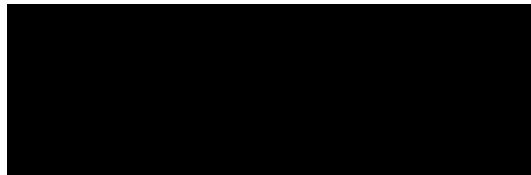

## DIMENSIONS (Unit: mm)

- Pressure welding unit

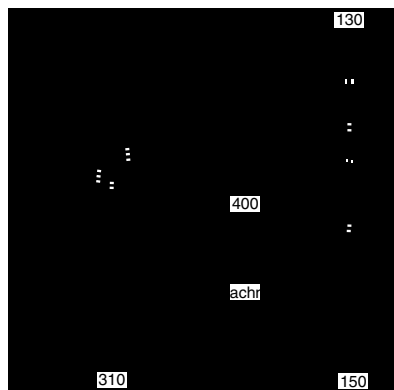

- Accessories



Attachment

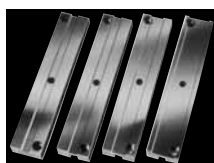

Center locator



Guide plate

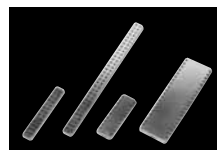

Spacer

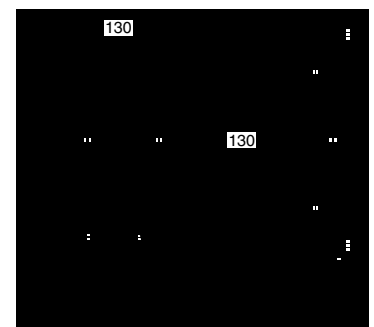





## NOTES

### 1. Sockets setting

After covers are temporary fixed with housing (or base), sockets are set at the gutter of center locator. (See Fig. 1)

### 2. Method of inserting flat cable

The guide plate is set at the correct figure of scale, corresponding to the number of contacts (cable width). Then cable is inserted along with the guide until it reaches at the stopper. (See Fig. 2)

### 3. Pressure connection

After adjusting the lower limit of the pressing plate, the connectors should be pressed. Since the guide plate is the stopper, the connectors should be pressed until contacting the pressing plate to the guide plate.

In case of PCB types, however, spacers should be placed over the base. (See Fig. 2)

### 4. Strain relief

Regarding MIL type, strain relief should be fixed manually after pressure connection of cables. (See Fig. 3)

**5. Be sure to use our pressure welding unit and its accessories when conducting pressure welding.**

## CABLE PRESSURE WELDING

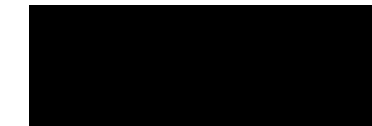

MIL type      PCB type

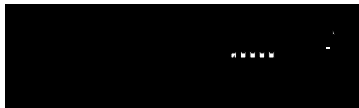
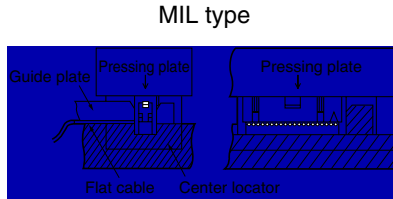

Fig. 1 Socket set condition



PCB type



Fig. 2 Pressure welding condition



Fig. 3 Set condition of strain relief

## SAFETY NOTES FOR SPECIALIZED TOOLS

### 1. Cable Cutter

- 1) Never remove the safety cover
- 2) Never insert your finger inside the safety cover
- 3) Use on a stable surface
- 4) Do not alter this product, or use it for other purposes

### 2. Pressure Welding Unit

- 1) Do not place fingers beneath the pressurized plate or in or near moving parts, while the lever is being operated.
- 2) Lock the unit in place on a workbench or the like.
- 3) Do not alter this product, or use it for other purposes



# HARNESS FABRICATION FOR FLAT CABLE CONNECTOR

## NOTES WHEN FABRICATING HARNESSES

### 1. Common items

- 1) Select the appropriate connector and cable according to the conditions of use.
- 2) It is recommended that our cable cutter and pressure welding unit be used.
- 3) After making the pressure welding, the condition of the connection should be confirmed.

- 4) Because there are standard terminal layout and reverse terminal layout for PCB type connectors, the connector suitable for the use should be selected.

### 2. Cable cutter

- 1) The cable should be cut at right angles to the corresponding length.
- 2) Use a sharp cutter for making the cut.
- 3) When setting the cable length, the pressure welding portion and strain relief coil should be considered and set accordingly.

For our product, the following cable length is necessary. (For each side)

MIL type socket	Without strain relief	6mm
	With strain relief	15mm
PCB type connector	Mini-dip type	7mm
	IC type 14 to 20 contacts	10mm
	IC type 24 and 40 contacts	20mm

### 3. Cable pressure welding

- 1) Bring the cable end surface in line with the connector end surface, and set in the groove of the cable guide of the protector.
- 2) When making a cable pressure welding for a PCB type connector, it is recommended that a spacer be used. This can prevent breakage of the terminals.

Example 1: MIL type and MIL type



Example 2: PCB type and PCB type  
Standard terminal layout

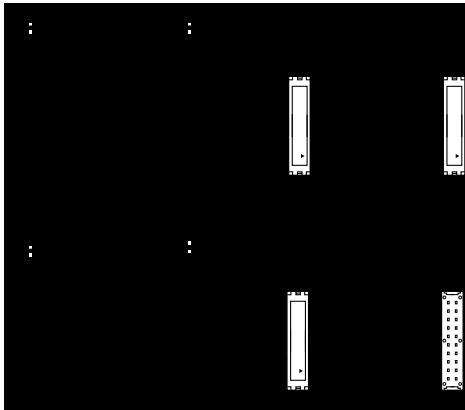

Reverse terminal layout

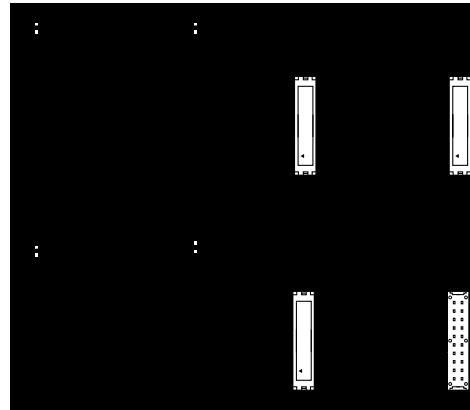

Example 3: PCB type and MIL type  
Standard terminal layout

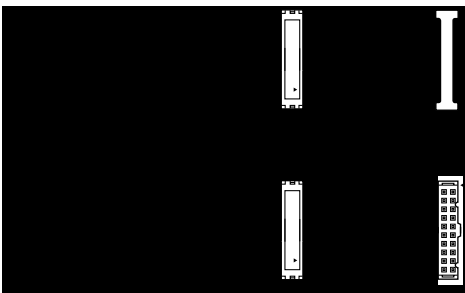

Reverse terminal layout

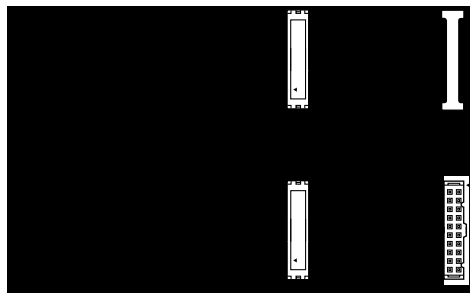



# HARNESS ASSEMBLY ORDERING INFORMATION

	Number of contacts for connector cable	Left connector type	Cable type and length	Right connector type
AXH connector harness designation	AXH			
Number of contacts for connector or cable				
Left connector type (see Note 1)				
Connection of connector and cable (see Note 2)				
Cable types Standard type: Stranded AWG 28: 1 Fluted type: Stranded AWG 28: 2				
Cable mark Front: 1 Rear: 2 Not specified: 3				
Cable length (3 digits) Example: 020 for 20 cm (Only 5 cm and longer available.)				
Right connector type (see Note 1)				
Connection of connector and cable (see Note 2)				

## Note 1) Connector type

Connector		Type	Order No.
MIL type connector		Without strain relief	M12
		With strain relief	M14
PCB type connector	Mini-dip type	Standard terminal layout	P42
		Reverse terminal layout	P46
	IC type	Reverse terminal layout	P56

## Note 2) Connection of connector and cable

Order No.	1	2	3	4	5	6	7	8
Left connector								
Right connector								
Cable mounting	Upper side			Lower side		Upper side		Lower side
Strain relief	Without strain relief				With strain relief			

We also accept orders for harnessed products. Call for more information.