

ALM-81224

High Linearity 1450 – 2750 MHz Variable Gain Amplifier



Data Sheet

Description

Avago Technologies' ALM-81224 is a high linearity variable-gain amplifier module for use in the 1450-2750MHz band. Gain control is achieved using a single DC voltage input pin. High linearity is achieved through the use of Avago Technologies' proprietary GaAs Enhancement-mode pHEMT process¹. It is housed in a miniature 6.0 x 6.0 x 1.0 mm 24-pin Molded Chip On Board (MCOB) package. Gain changes monotonically with gain control pin voltage. Input is fully matched. Output match can be tuned for optimal performance at a particular frequency band within the VGA operation frequency range using common RF board layout. The compact footprint coupled with high linearity and efficiency makes ALM-81224 an ideal choice for Basestation transmitters and receivers and Temperature Compensation Circuitry applications.

Component Image

(6.0 x 6.0 x 1.0) mm 24-lead MCOB



Note:
Package marking provides orientation and identification
"81224" = Device Code
"WWYY" = Date Code identifies month and year of manufacturing
"XXXX" = Last 4 digit of assembly lot number

Pin Configuration

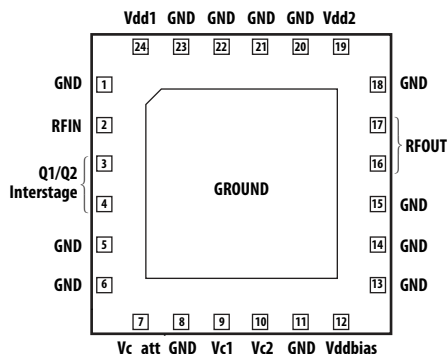

Features

- High Linearity at low bias current
- High max gain: 23.8 dB typ
- High linearity performance: +16.5 dBm at -65 dBc ACLR using dual-carrier W-CDMA input signal
- Fully-matched 50 Ohm input and simple output match
- Low Noise Figure
- Built-in attenuator with monotonic response
- Variable Gain range: 38 dB typ
- GaAs E-pHEMT Technology [1]
- Small package size: 6.0 x 6.0 x 1.0 mm

Typical Performances

2140 MHz @ 5 V, 383 mA (typ)

- 23.8 dB Gain at minimum attenuation
- +16.5 dBm output power (-65 dBc ACLR) using dual-carrier W-CDMA input signal with PAPR = 7.5 dB.
- NF: 2dB @ max gain and 16 dB @ min gain
- P1dB: 27.4 dBm
- Attenuator range: 38 dB with Vc_att: (0 V – 3.3 V)
- Shutdown current (Vc1, Vc2 = 0 V): < 30 μ A

Applications

- Basestation Transmitter, Receiver and Temperature Compensation Circuits requiring continuously variable gain functionality

Note:

1. Enhancement mode technology employs positive Vgs, thereby eliminating the need of negative gate voltage associated with conventional depletion mode devices.



Attention: Observe precautions for handling electrostatic sensitive devices.

ESD Machine Model = 50 V
ESD Human Body Model = 500 V
Refer to Avago Application Note A004R:
Electrostatic Discharge, Damage and Control.

Table 1. ALM-81224 Absolute Maximum Rating [1]

Symbol	Parameter	Units	Absolute Maximum
V _{dd,max}	Drain Voltage, RF output to ground	V	5.5
V _{ctrl,max}	Control Voltage [4]	V	5.5
I _{ds,max}	Device Drain Current	mA	500
P _d	Power Dissipation [2]	W	2.75
P _{in}	CW RF Input Power	dBm	22
T _j	Junction Temperature	°C	150
T _{stg}	Storage Temperature	°C	-65 to 150

Thermal Resistance

Thermal Resistance [3]
(V_d = 5.0 V, I_d = 320 mA, T_c = 85°C)
θ_{jc} = 20°C/W

Notes:

1. Operation of this device in excess of any of these limits may cause permanent damage.
2. Ground Paddle temperature is 25° C. Derate 50 mW/°C for T_c > 95° C.
3. Thermal resistance measured using 150° C Infra-Red Microscopy Technique.
4. V_{c1}/V_{c2} ≤ V_{dd1}/V_{dd2}.

Table 2. Electrical Specifications

T_A = 25° C, V_{dd1} = V_{dd2} = V_{Bias} = 5 V @ total quiescent current of 383 mA, RF performance at 2140 MHz, CW operation unless otherwise stated.

Symbol	Parameter and Test Condition	Units	Freq.	Min.	Typ.	Max.
V _{dd}	Supply Voltage				5	
I _{dq_total}	Quiescent Supply Current	mA		290	383	460
Freq	Operating Frequency Range	MHz		1450		2750
Max Gain	Max Gain (minimum attenuation) [1]	dB	1485 1840 1960 2140 2650	– – – 22.2 –	27.0 24.9 24.8 23.8 21.5	
NF	Noise Figure (minimum attenuation)	dB			2	
OP1dB	Output Power at 1dB Gain Compression [1]	dBm	1485 1840 1960 2140 2650	– – – 24.7 –	28.0 27.7 28.7 27.4 28.3	
OIP3	Output Third Order Intercept Point [2]	dBm			44	
ACLR	ACLR at linear P _{out} = 12 dBm with dual-carrier W-CDMA input signal [1,3]	dBc	1485 1840 1960 2140 2650		-67.1 -68.4 -67.6 -66.6 -67.5	– – – -63.5 –
I _{linear_total}	Total current draw at P _{linear} level	mA		290	383	460
S11	Input Return Loss, 50 Ω source	dB	2140		-15	
S22	Output Return Loss, 50 Ω load	dB	2140		-10	
S12	Reverse Isolation	dB	2140		40	
Atten	Gain attenuation range, V _{c_att} : (0 V – 3.3 V)	dB			38	

Notes:

1. Measured with output match tuned to frequency as specified. See Table 3 for component values.
2. OIP3 test condition: F_{RF1} - F_{RF2} = 1 MHz with input power of -8 dBm per tone measured at worst side band.
3. Peak-to-average power ratio = 7.5 dB. Measured on Agilent MXA N9020A with low-noise option. Refer to Figure 77 for CCDF.

ALM-81224 Consistency Distribution Charts

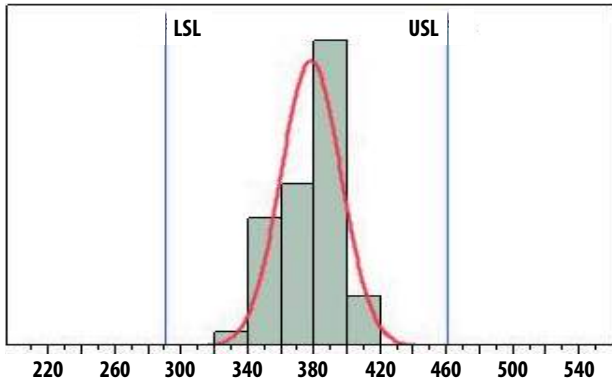

Figure 1. I_{dd_total} at V_{dd} = 5 V; LSL = 290 mA, Nominal = 383 mA, USL = 460 mA

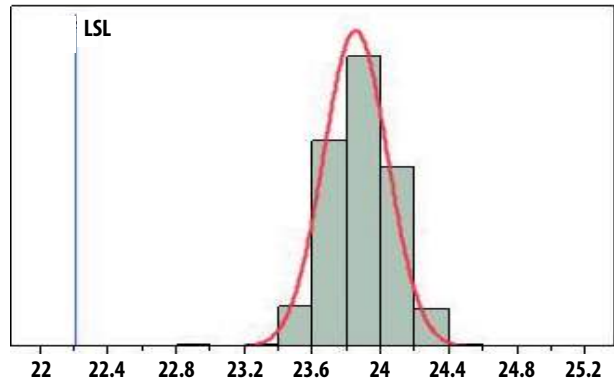

Figure 2. Max gain at 2140 MHz; LSL = 22.2 dB, Nominal = 23.8 dB

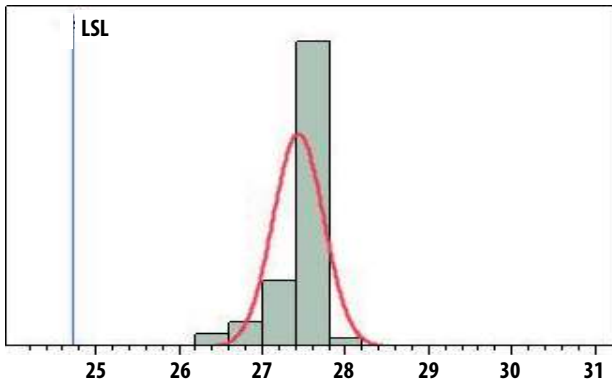

Figure 3. OP1dB; LSL = 24.7 dBm, Nominal = 27.4 dBm

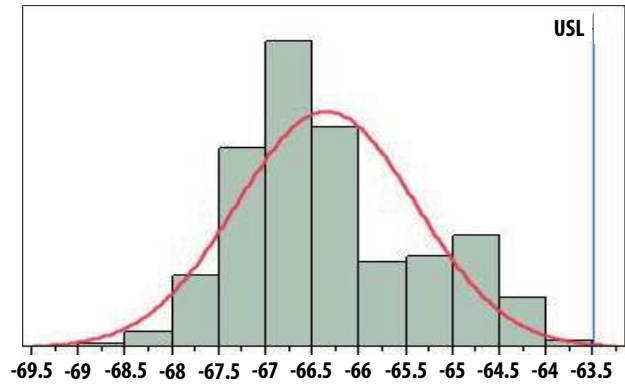

Figure 4. ACLR (Dual-Carrier Signal) at 12 dBm output power; Nominal = -66.6 dBc, USL = -63.5 dBc

Typical DC Performance Plots

$T_A = 25^\circ\text{C}$, $V_{dd} = V_{dd2} = V_{Bias} = 5\text{ V}$ @ 383 mA, RF performance tuned at 2140 MHz using demoboard of Figure 71. CW operation unless otherwise stated. Dual Carrier Signal uses W-CDMA modulation with 7.5 dB crest factor. Refer to Figure 77 for CCDF. Single Carrier Signal uses WCDMA Test Tone #1.

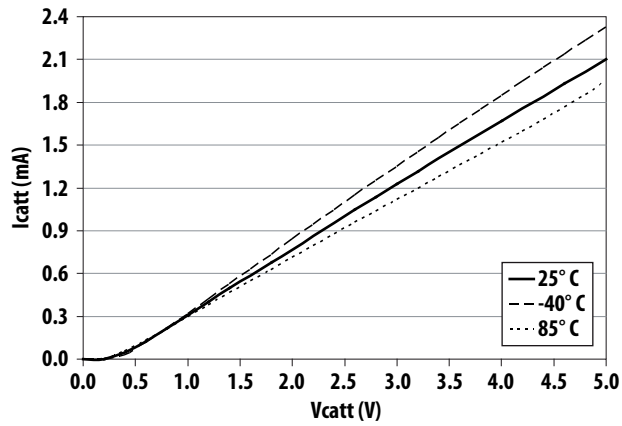

Figure 5. I_{c_att} Vs V_{c_att}

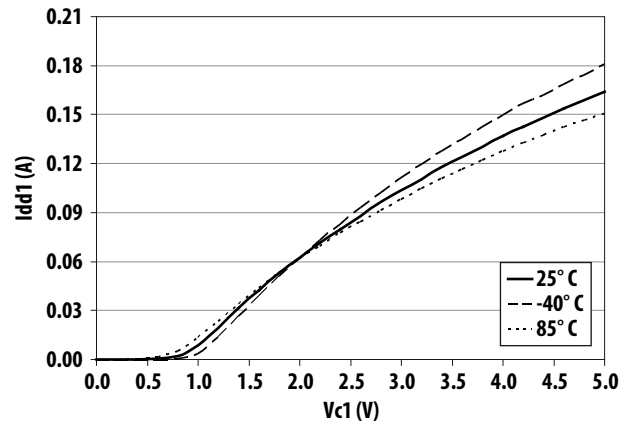

Figure 6. I_{dd1} Vs V_{c1}

$V_{ddbias} = 5\text{ V}$, $V_{c2} = 0\text{ V}$, $V_{dd1} = V_{dd2} = 5\text{ V}$, $V_{c_att} = 0\text{ V}$

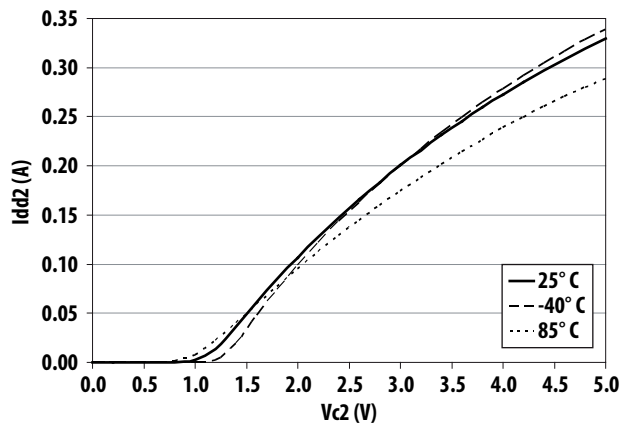

Figure 7. I_{dd2} Vs V_{c2}

$V_{ddbias} = 5\text{ V}$, $V_{c1} = 0\text{ V}$, $V_{dd1} = V_{dd2} = 5\text{ V}$, $V_{c_att} = 0\text{ V}$

Typical 1485 MHz RF Performance Plots

Application circuit and build of material can be seen in Figure 70 and Table 3 respectively.

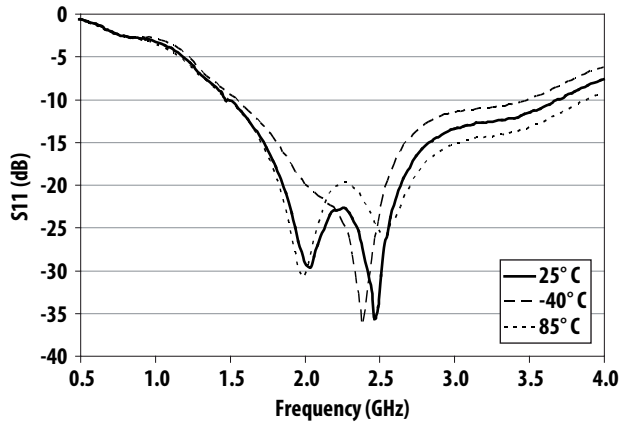

Figure 8. S11 vs Freq at 1485 MHz

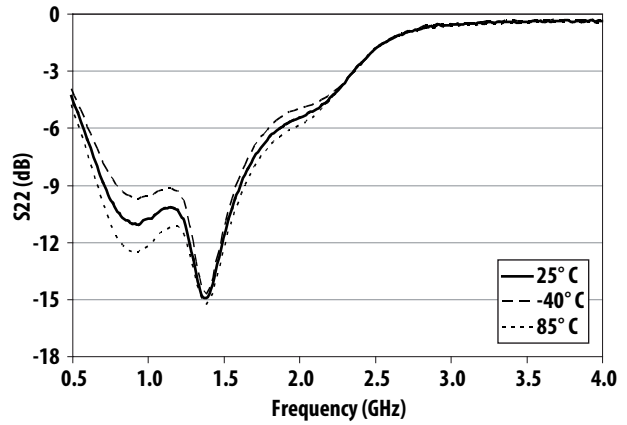

Figure 9. S22 vs Freq at 1485 MHz

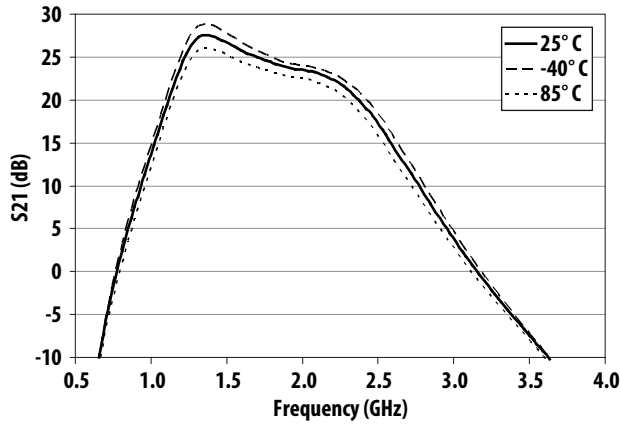

Figure 10. S21 vs Freq at 1485 MHz

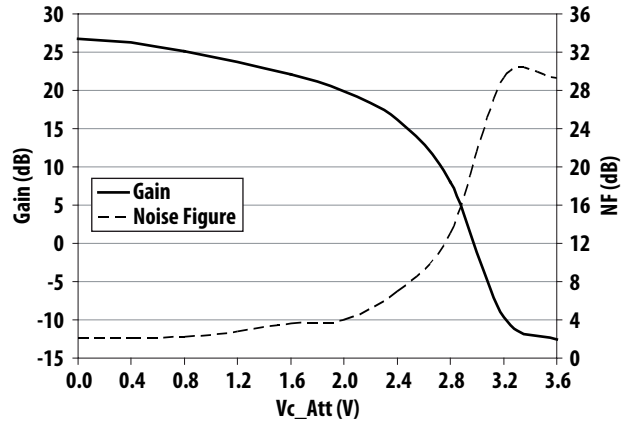

Figure 11. Gain & Noise Figure vs Vc_att at 1485 MHz at 25°C

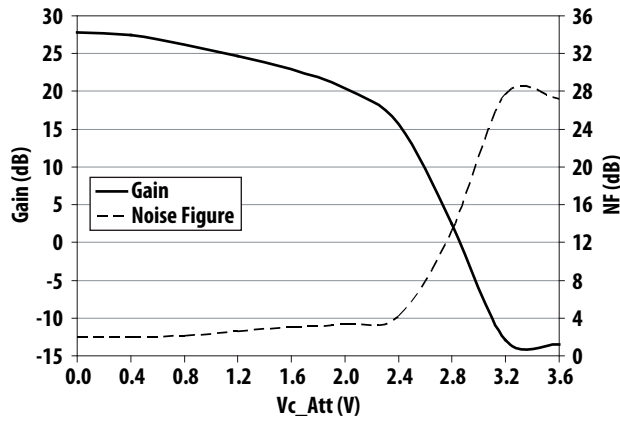

Figure 12. Gain & Noise Figure vs Vc_att at 1485 MHz at -40°C

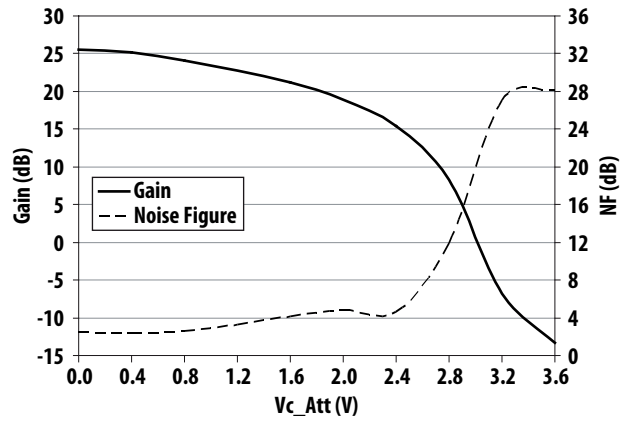

Figure 13. Gain & Noise Figure vs Vc_att at 1485 MHz at 85°C

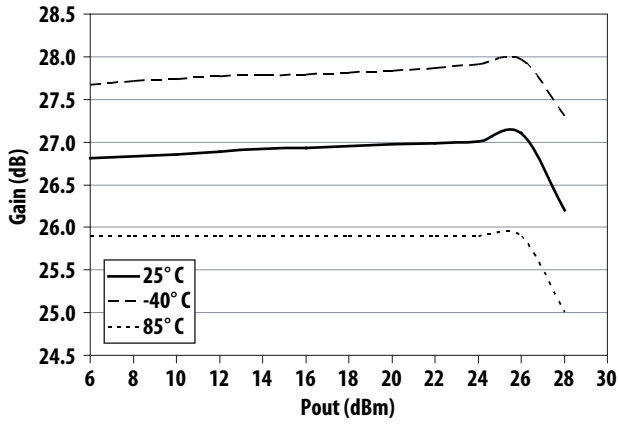

Figure 14. Gain vs Pout at 1485 MHz

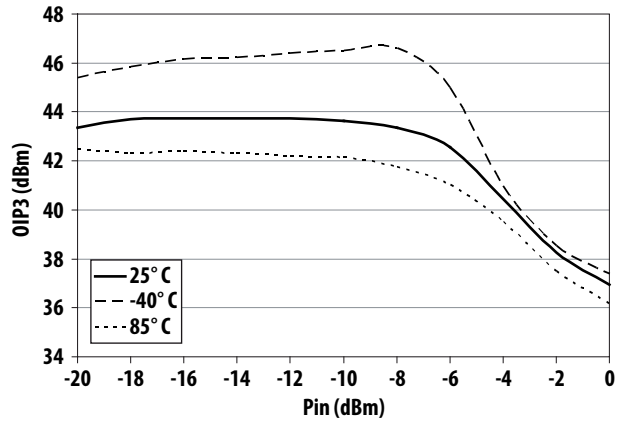

Figure 15. OIP3 vs Pin at 1485 MHz

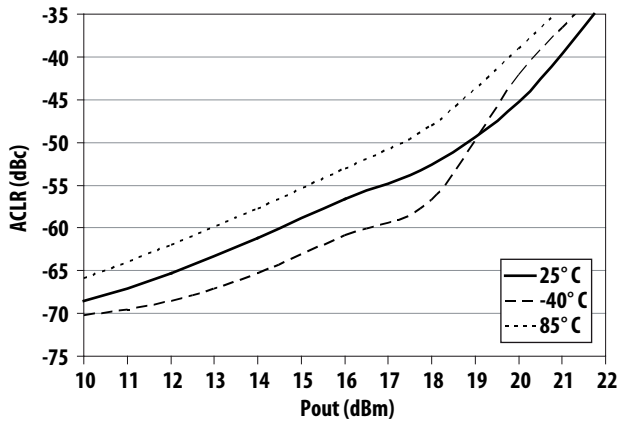

Figure 16. ACLR (Dual Carrier Signal) vs Pout at 1485 MHz

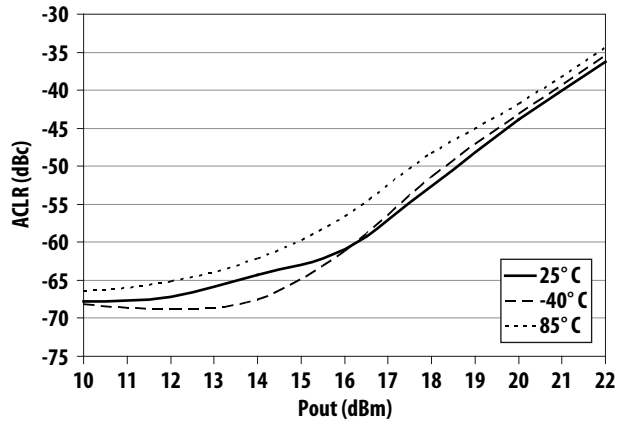

Figure 17. ACLR (Single Carrier Signal) vs Pout at 1485 MHz

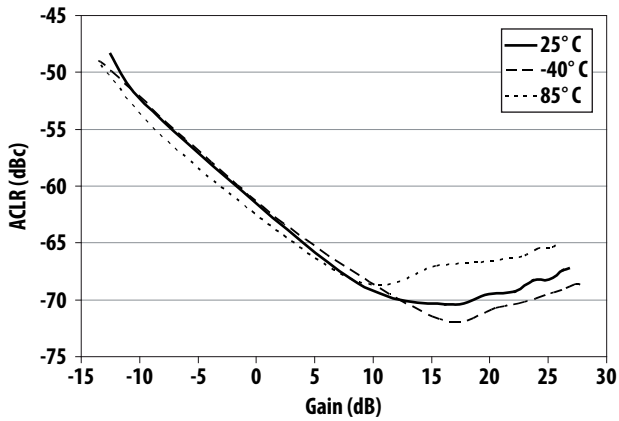

Figure 18. ACLR (Dual Carrier Signal) vs Gain at 1485 MHz

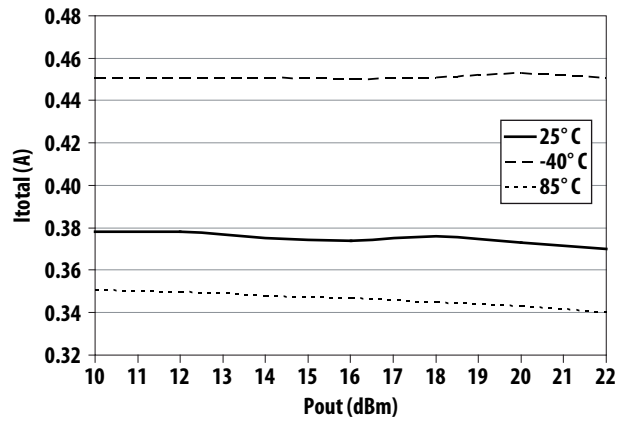

Figure 19. Idd_total vs Pout (Dual Carrier Signal) at 1485 MHz

Typical 1840 MHz RF Performance Plots

Application circuit and build of material can be seen in Figure 70 and Table 3 respectively.

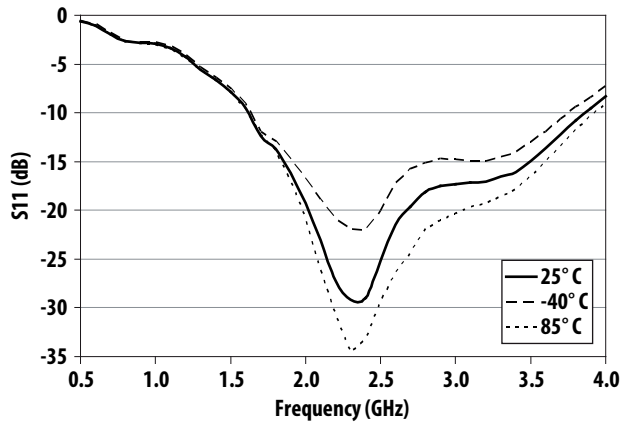

Figure 20. S11 vs Freq at 1840 MHz

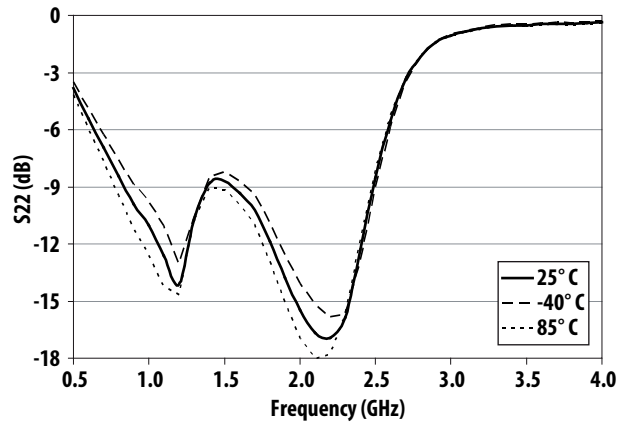

Figure 21. S22 vs Freq at 1840 MHz

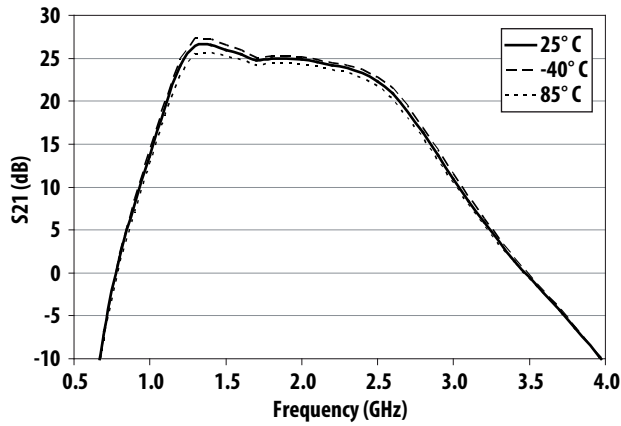

Figure 22. S21 vs Freq at 1840 MHz

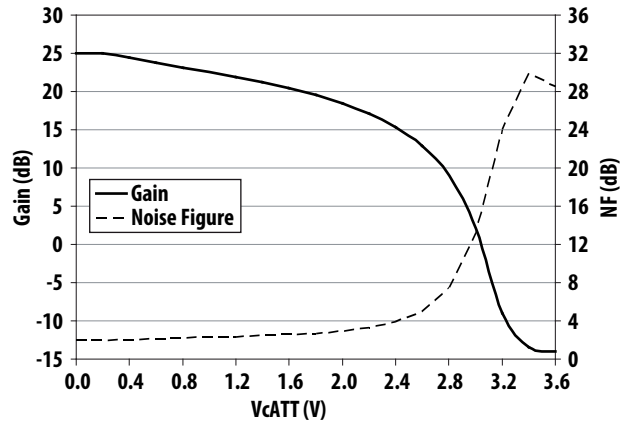

Figure 23. Gain & Noise Figure vs Vc_att at 1840 MHz at 25°C

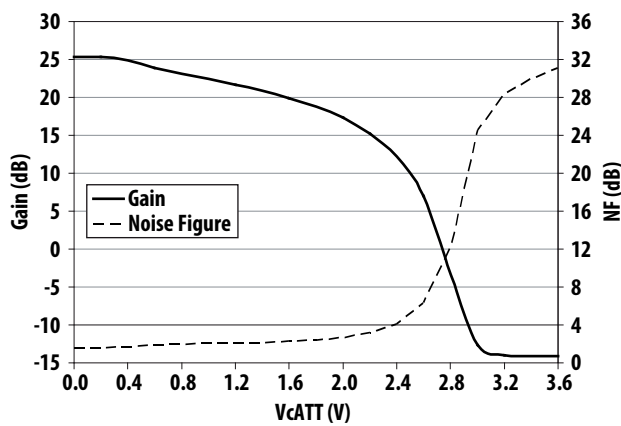

Figure 24. Gain & Noise Figure vs Vc_att at 1840 MHz at -40°C

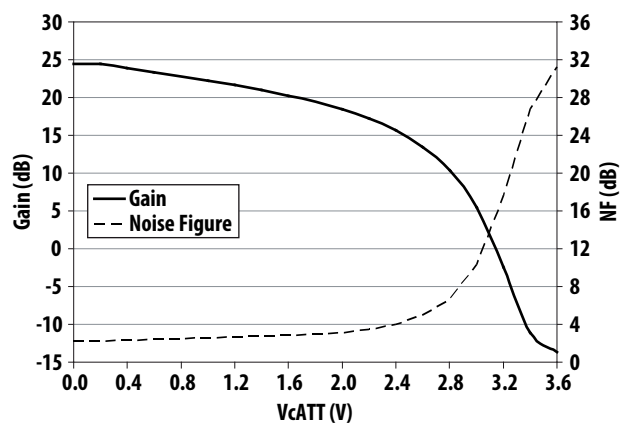

Figure 25. Gain & Noise Figure vs Vc_att at 1840 MHz at 85°C

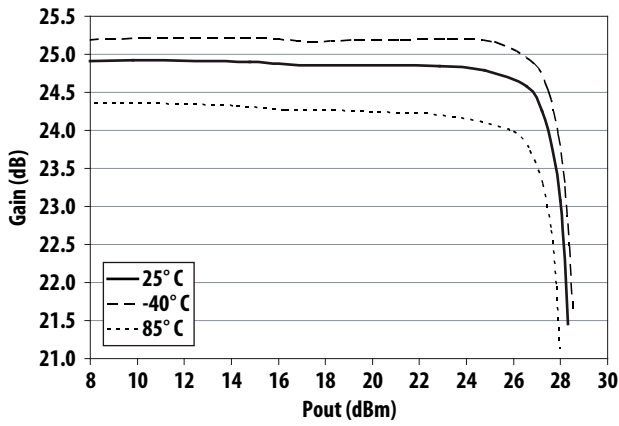

Figure 26. Gain vs Pout at 1840 MHz

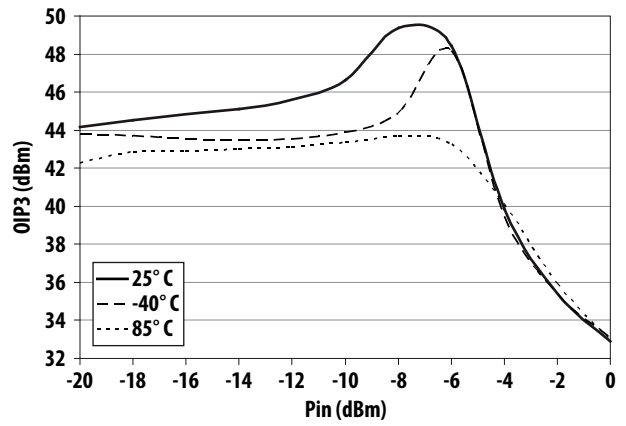

Figure 27. OIP3 vs Pin at 1840 MHz

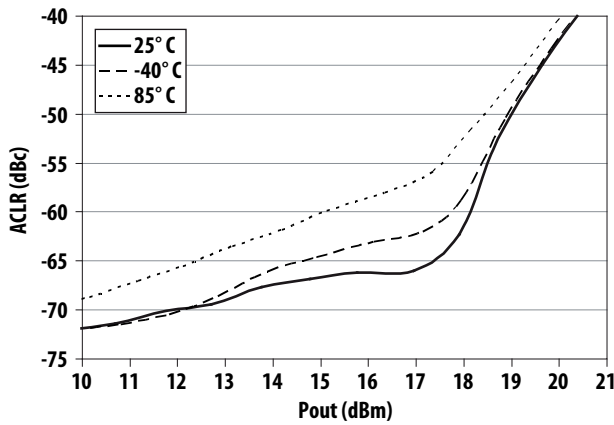

Figure 28. ACLR (Dual Carrier Signal) vs Pout at 1840 MHz

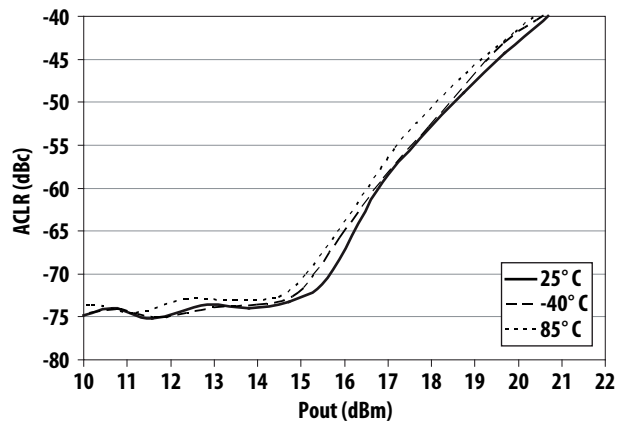

Figure 29. ACLR (Single Carrier Signal) vs Pout at 1840 MHz

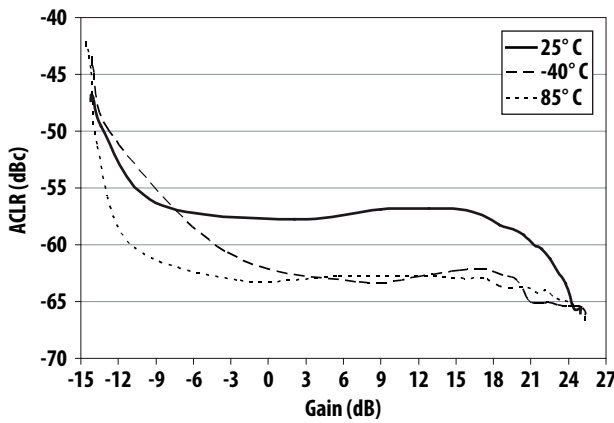

Figure 30. ACLR (Dual Carrier Signal) vs Gain at 1840 MHz

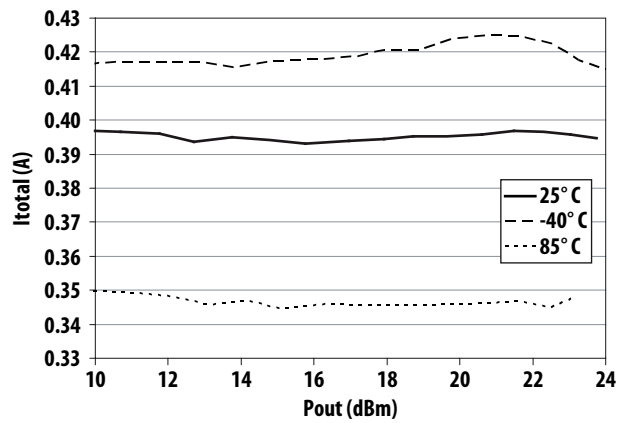

Figure 31. Idd_total vs Pout (Dual Carrier Signal) at 1840 MHz

Typical 1960 MHz RF Performance Plots

Application circuit and build of material can be seen in Figure 70 and Table 3 respectively.

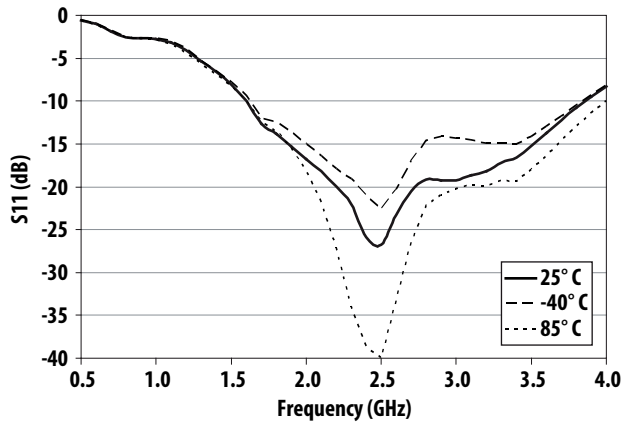

Figure 32. S11 vs Freq at 1960 MHz

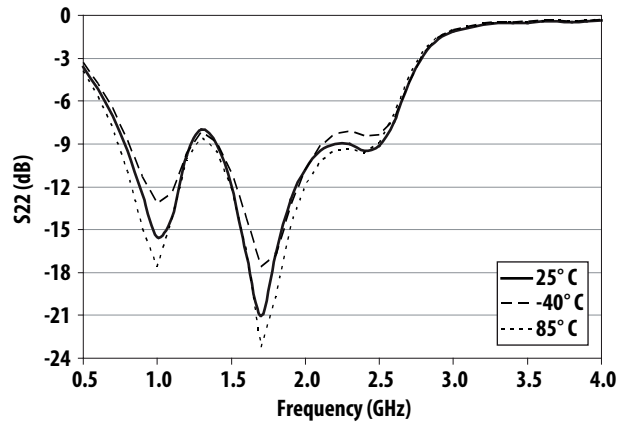

Figure 33. S22 vs Freq at 1960 MHz

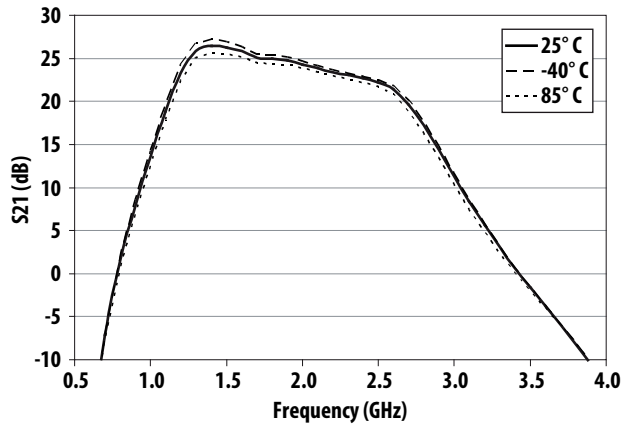

Figure 34. S21 vs Freq at 1960 MHz

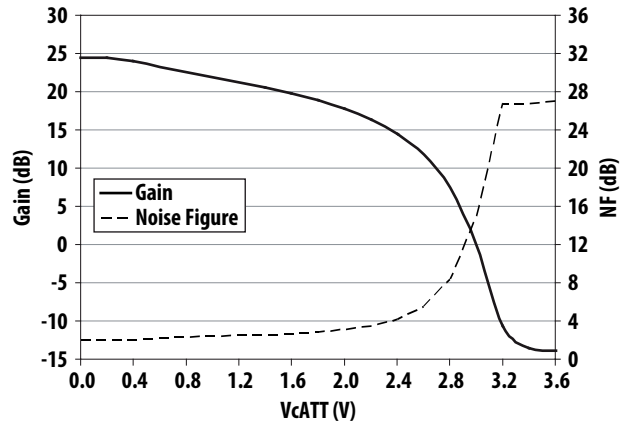

Figure 35. Gain & Noise Figure vs Vc_att at 1960 MHz at 25°C

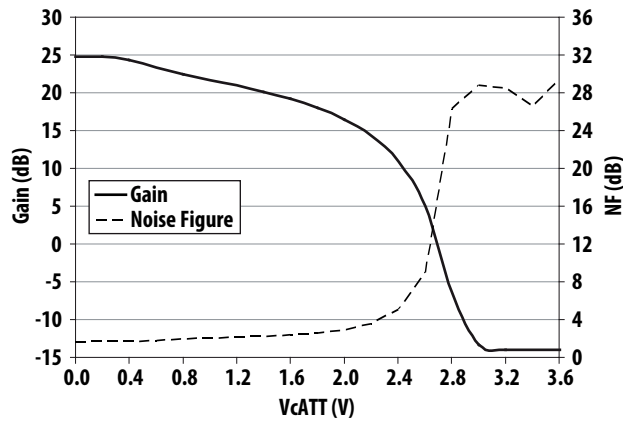

Figure 36. Gain & Noise Figure vs Vc_att at 1960 MHz at -40°C

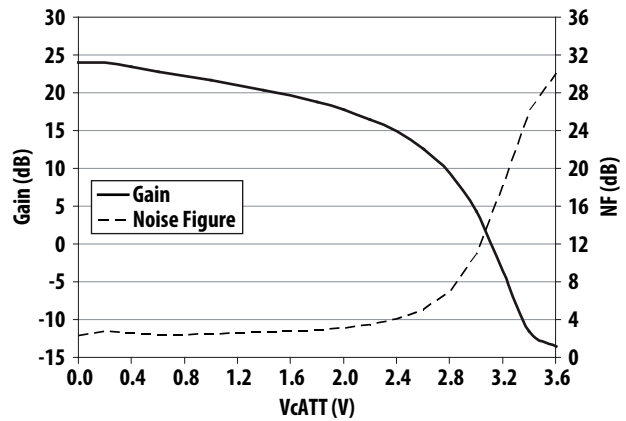

Figure 37. Gain & Noise Figure vs Vc_att at 1960 MHz at 85°C

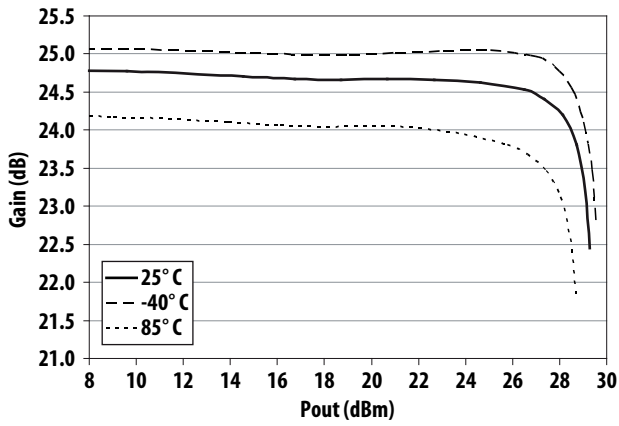

Figure 38. Gain vs Pout at 1960 MHz

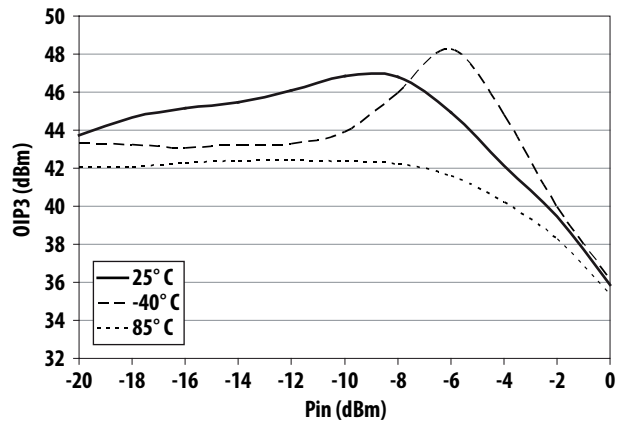

Figure 39. OIP3 vs Pin at 1960 MHz

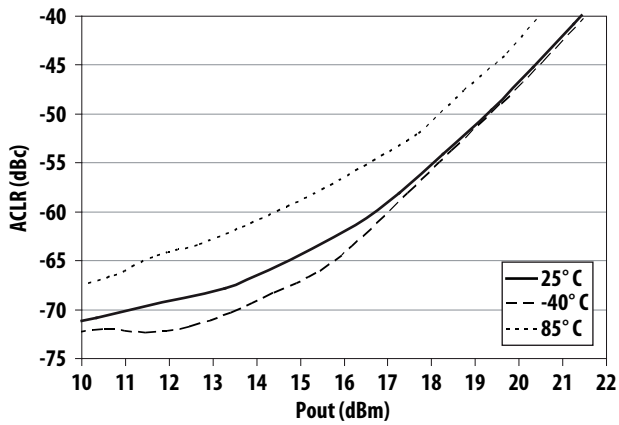

Figure 40. ACLR (Dual Carrier Signal) vs Pout at 1960 MHz

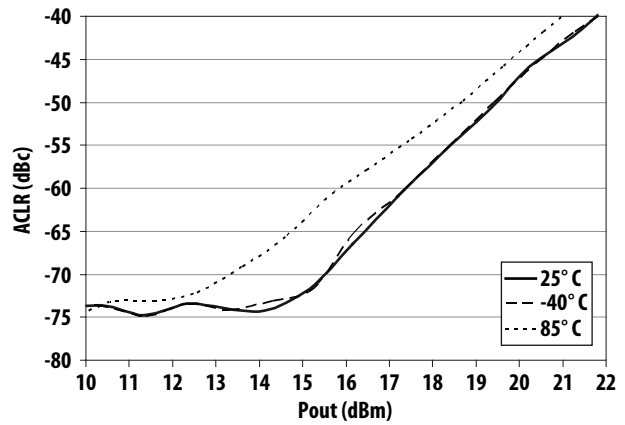

Figure 41. ACLR (Single Carrier Signal) vs Pout at 1960 MHz

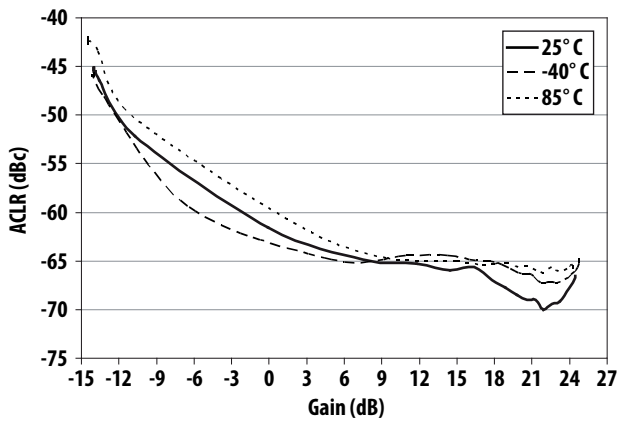

Figure 42. ACLR (Dual Carrier Signal) vs Gain at 1960 MHz

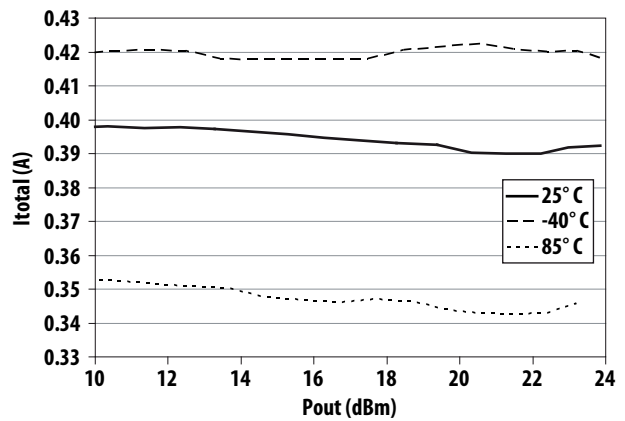

Figure 43. Idd_total vs Pout (Dual Carrier Signal) at 1960 MHz

Typical 2140 MHz RF Performance Plots

Application circuit and build of material can be seen in Figure 70 and Table 3 respectively.

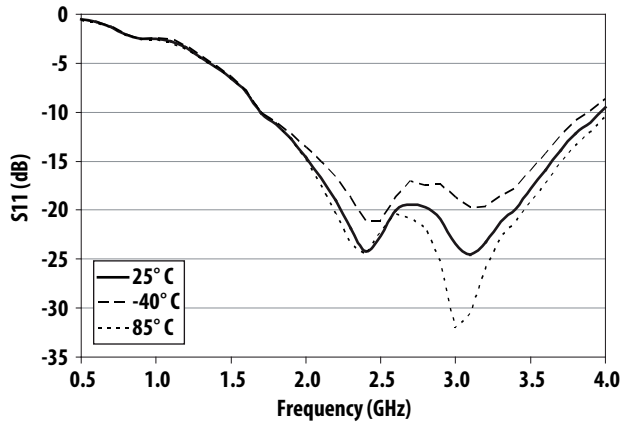

Figure 44. S11 vs Freq at 2140 MHz

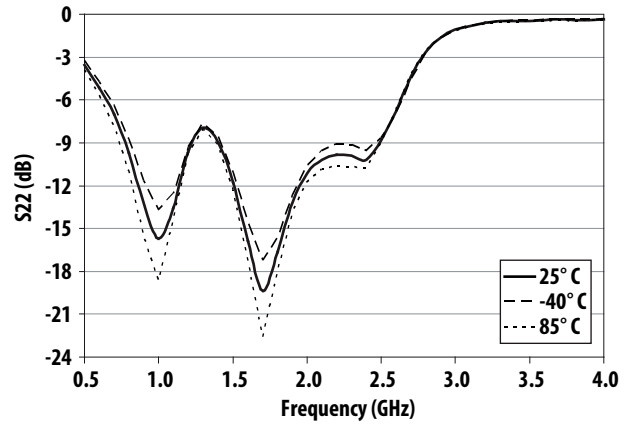

Figure 45. S22 vs Freq at 2140 MHz

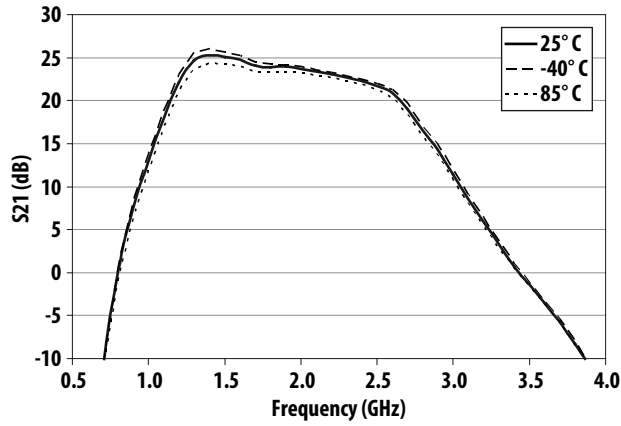

Figure 46. S21 vs Freq at 2140 MHz

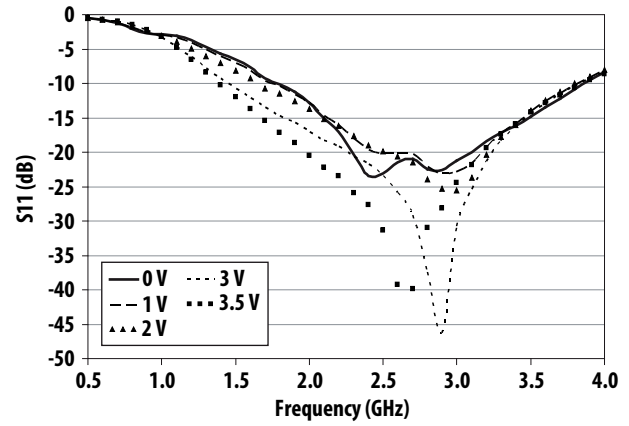

Figure 47. S11 vs Freq at different Vc_att at 2140 MHz at 25°C

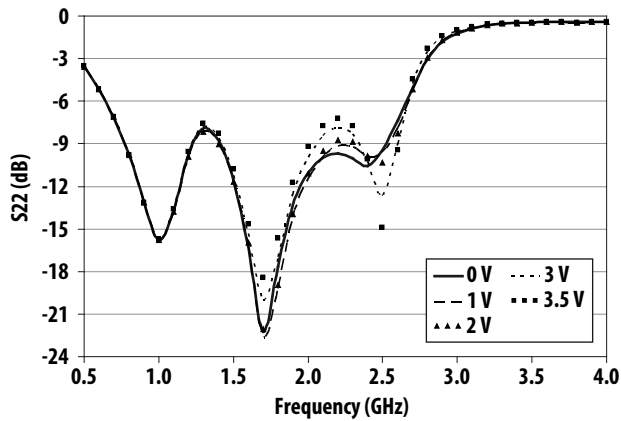

Figure 48. S22 vs Freq at different Vc_att at 2140 MHz at 25°C

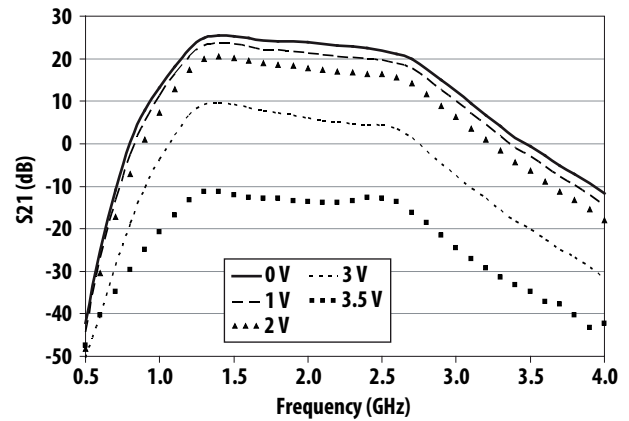

Figure 49. S21 vs Freq at different Vc_att at 2140 MHz at 25°C

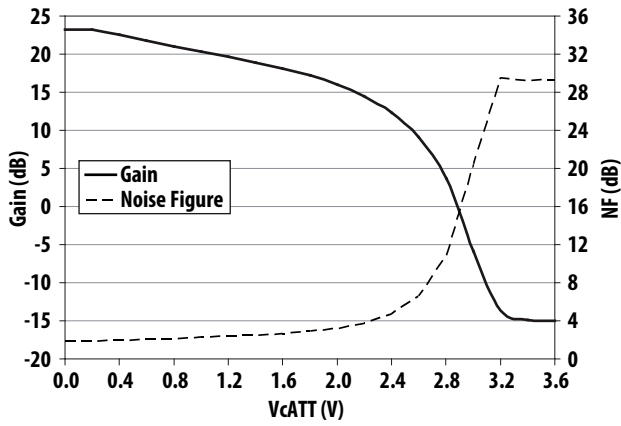

Figure 50. Gain & Noise Figure vs Vc_att at 2140 MHz at 25° C

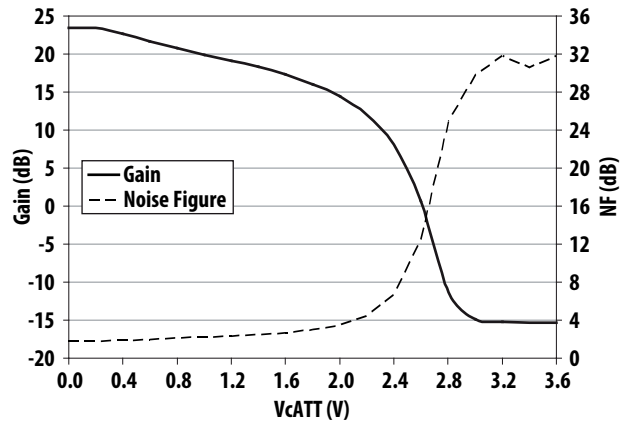

Figure 51. Gain & Noise Figure vs Vc_att at 2140 MHz at -40° C

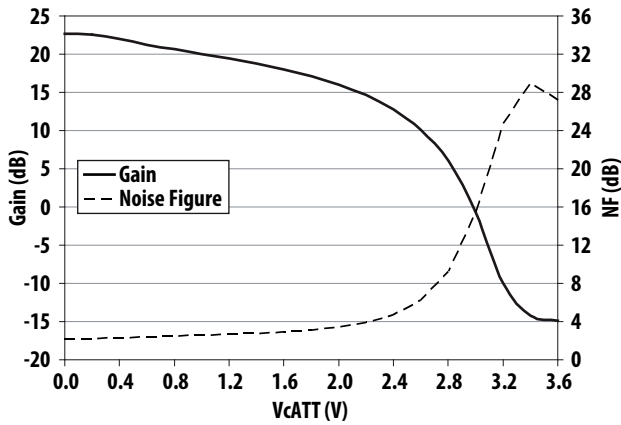

Figure 52. Gain & Noise Figure vs Vc_att at 2140 MHz at 85° C

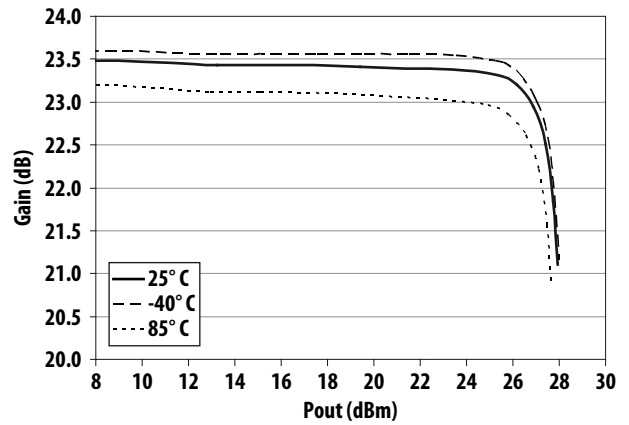

Figure 53. Gain vs Pout at 2140 MHz

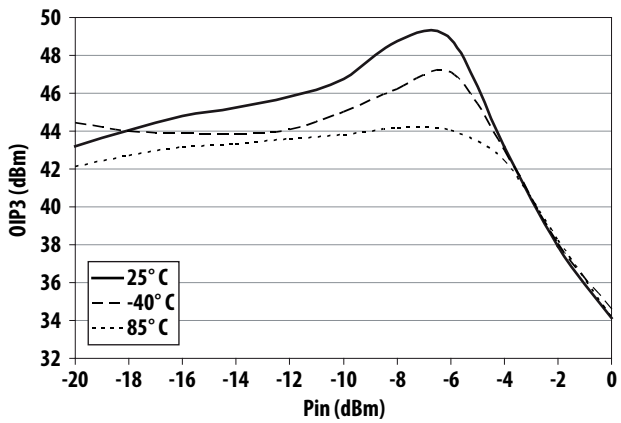

Figure 54. OIP3 vs Pin at 2140 MHz

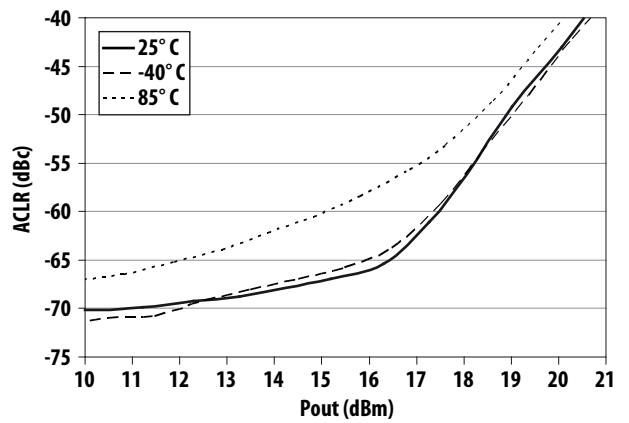

Figure 55. ACLR (Dual Carrier Signal) vs Pout at 2140 MHz

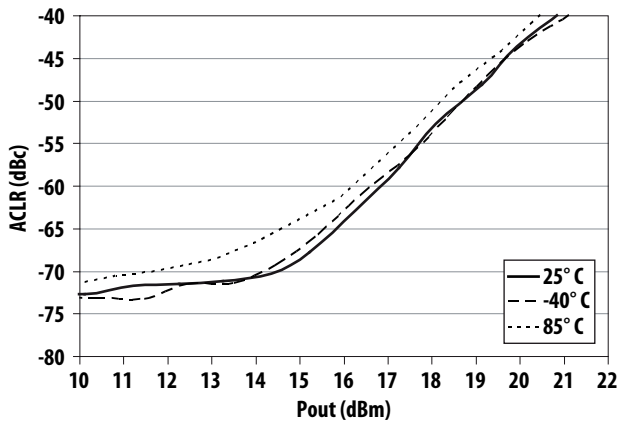

Figure 56. ACLR (Single Carrier Signal) vs Pout at 2140 MHz

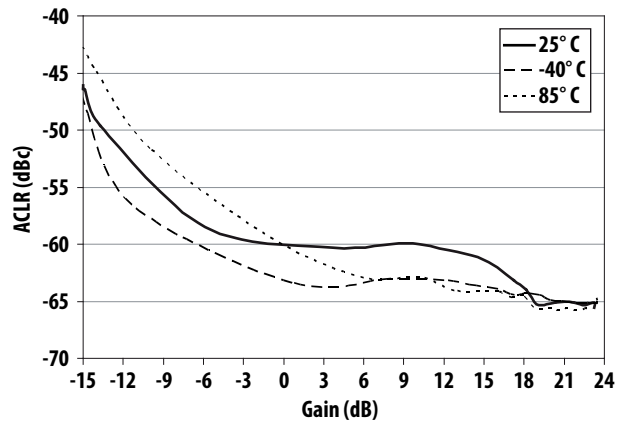

Figure 57. ACLR (Dual Carrier Signal) vs Gain at 2140 MHz

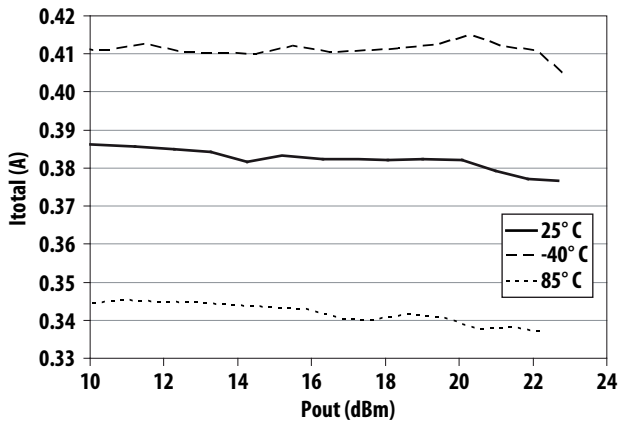

Figure 58. Idd_total vs Pout (Dual Carrier Signal) at 2140 MHz

Typical 2650 MHz RF Performance Plots

Application circuit and build of material can be seen in Figure 70 and Table 3 respectively.

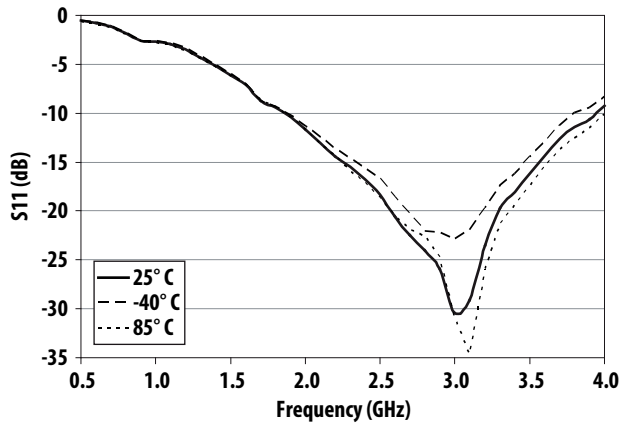

Figure 59. S11/S22/S21 vs Freq at 2650 MHz at 25° C

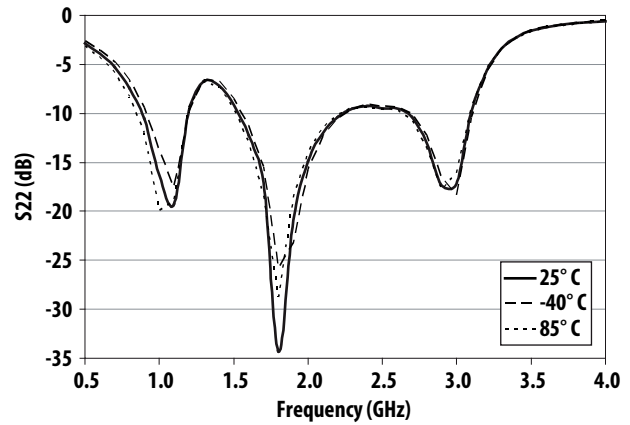

Figure 60. S11/S22/S21 vs Freq at 2650 MHz at -40° C

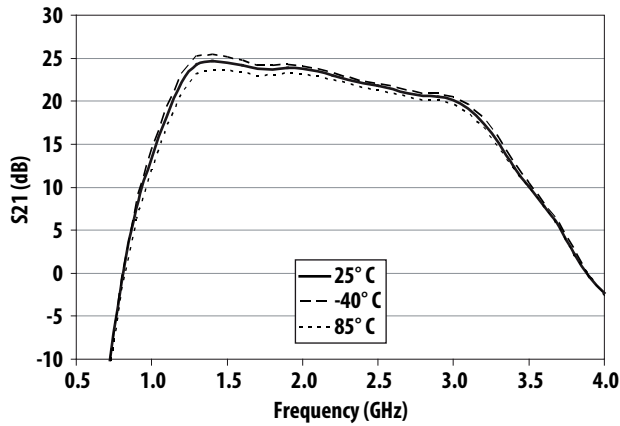

Figure 61. S11/S22/S21 vs Freq at 2650 MHz at 85° C

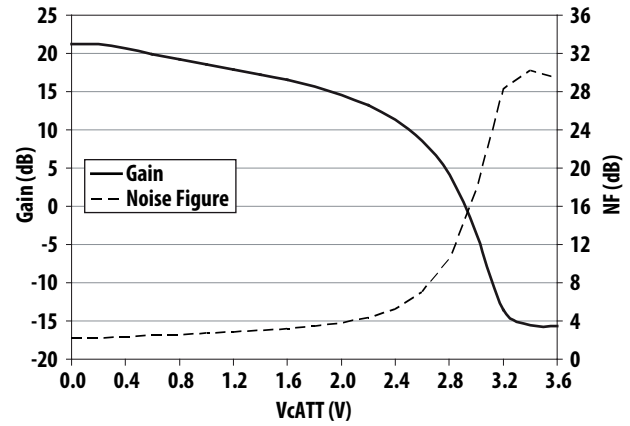

Figure 62. Gain & Noise Figure vs Vc_att at 2650 MHz at 25° C

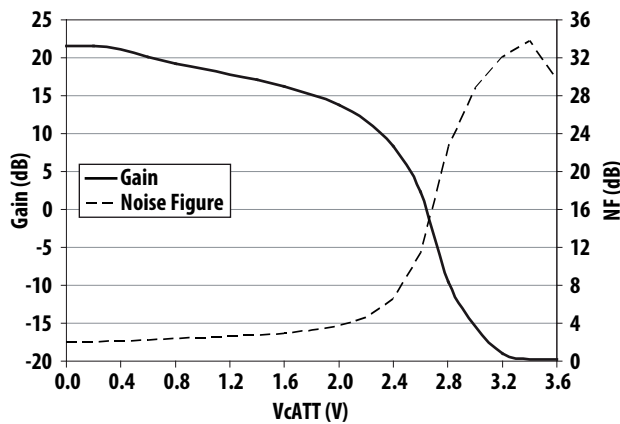

Figure 63. Gain & Noise Figure vs Vc_att at 2650MHz at -40° C

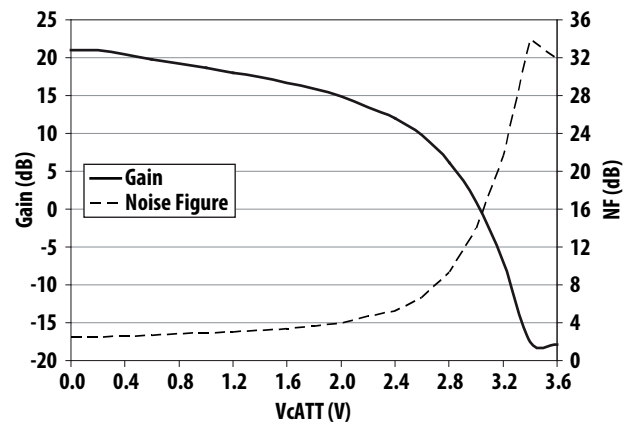

Figure 64. Gain & Noise Figure vs Vc_att at 2650 MHz at 85° C

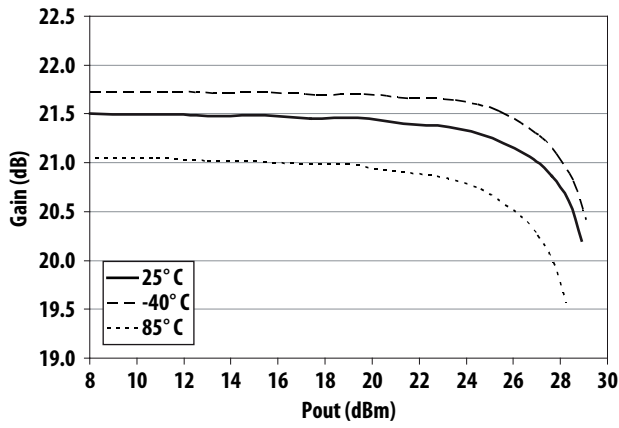

Figure 65. Gain vs Pout at 2650 MHz

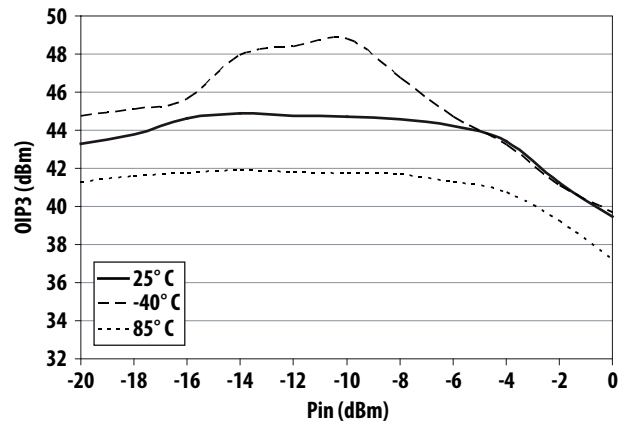

Figure 66. OIP3 vs Pin at 2650 MHz

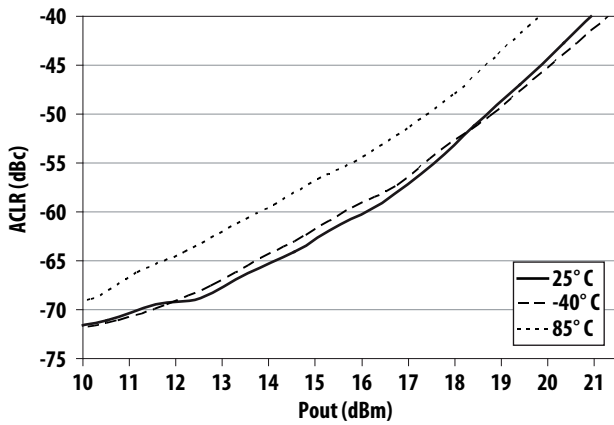

Figure 67. ACLR (Dual Carrier Signal) vs Pout at 2650 MHz

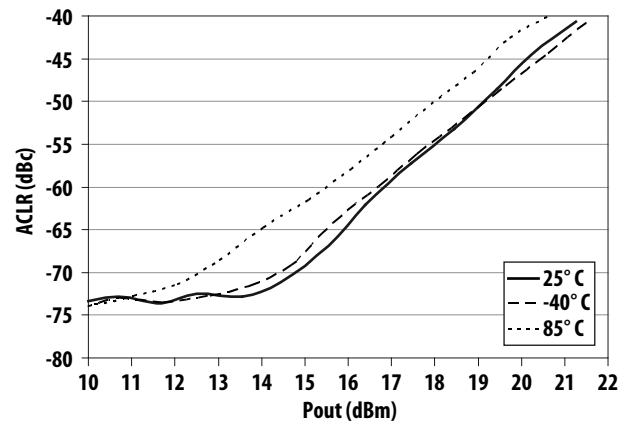

Figure 68. ACLR (Single Carrier Signal) vs Pout at 2650 MHz

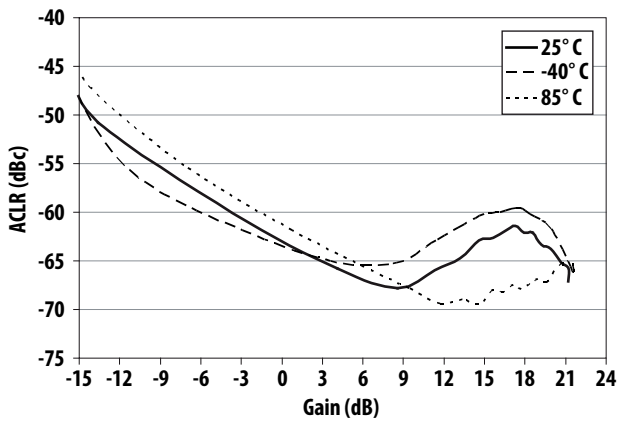

Figure 69. ACLR (Dual Carrier Signal) vs Gain at 2650 MHz

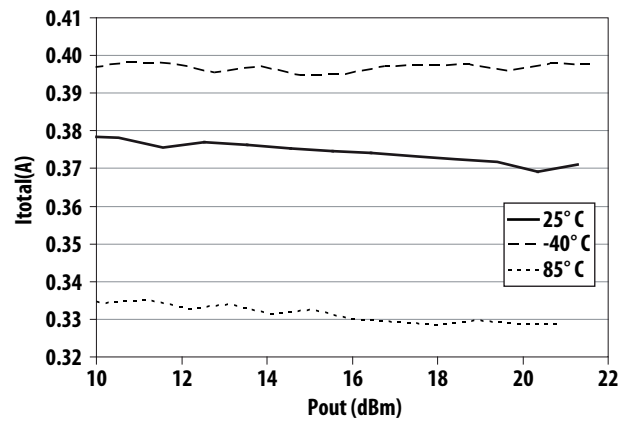

Figure 70. Idd_total vs Pout (Dual Carrier Signal) at 2650 MHz

Application Circuit Description and Layout

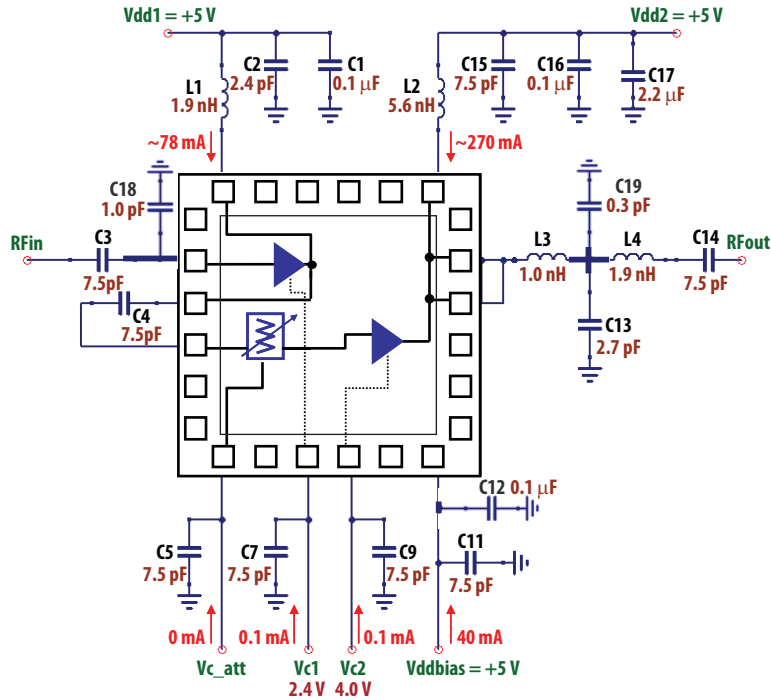

Figure 71. Application circuit tuned for 2140 MHz operation using 0402 size external SMT components

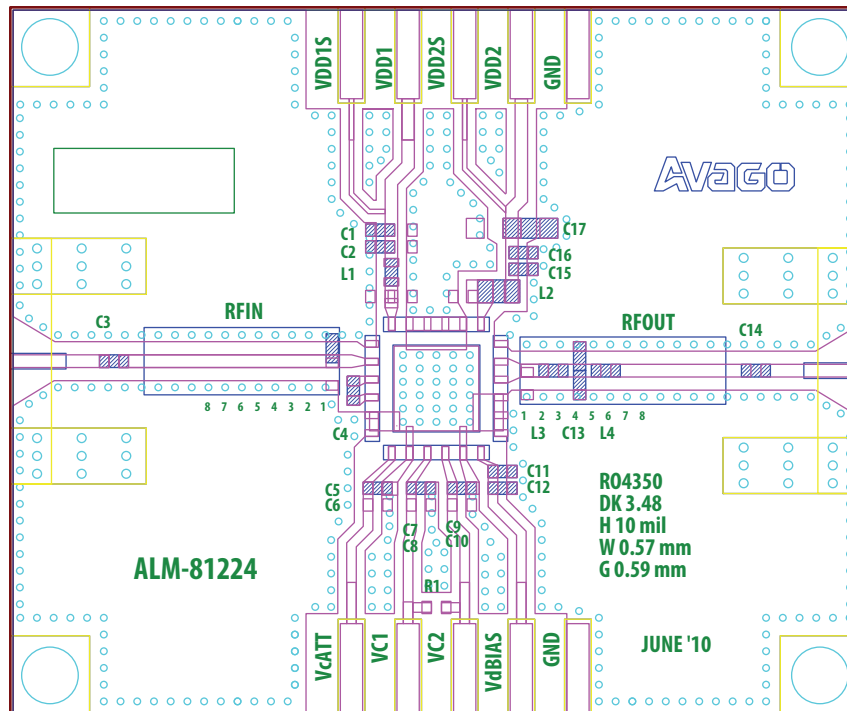

Figure 72. Demo board diagram of application circuit for 2140 MHz

Notes:

1. The VGA is capable of wideband operation from 1450-2750 MHz. Optimum linearity and Gain at different frequencies can be tuned by changing the values of L3, L4, C13, C19 at the output match and L1, L2 at the supply lines. Table 3 below shows the optimum linearity tuning components.
2. Optimum linearity is achieved by varying Vc1 and Vc2. Typical current is as shown in the figure above.
3. If lower output power for the same linearity is desired, then the bias currents Idd1 and Idd2 can be reduced by reducing Vc1 and Vc2 respectively.

Recommended Bill of Materials

Table 3. Component Values

Circuit Symbol	Freq (MHz)	Size	Description		
			Value	Part Number	Manufacturer
C1, C12, C16	All	0402	0.1 μ F	GRM155F51C104ZA01E	Murata
C2	All	0402	2.4 pF	GJM1555C1H2R4CB01	Murata
C3*, C4, C5, C7, C9, C11, C14*, C15	All	0402	7.5 pF	GJM1555C1H7R5DB01	Murata
C6, C8, C10	All	0402	NOT USED		
C13	1485	0402	3.3 pF	GJM1555C1H3R3CB01	Murata
	1840	0402	2.4 pF	GJM1555C1H2R4CB01	Murata
	1960 / 2140	0402	2.7 pF	GJM1555C1H2R7CB01	Murata
	2650	0402	2.0 pF	GJM1555C1H2R0CB01	Murata
C17	All	0603	2.2 μ F	GRM21BR61A225KA01L	Murata
C18	All	0402	1.0 pF	GJM1555C1H1R0CB01	Murata
C19	1485 / 1960 / 2140	0402	0.3 pF	GJM1555C1HR30BB	Murata
	1840 / 2650	0402	NOT USED		
L1	1485	0402	9.0 nH	0402CS-9N0X_LU	Coilcraft
	1840 / 1960	0402	5.6 nH	0402CS-5N6X_LU	Coilcraft
	2140	0402	1.9 nH	0402CS-1N9X_LU	Coilcraft
	2650	0402	1.0 nH	0402CS-1N0X_LU	Coilcraft
L2	1485 / 1840 / 1960 / 2140 / 2650	0402	5.6 nH	0402CS-5N6X_LU	Coilcraft
L3	1485	0402	2.2 nH	0402CS-2N2X_LU	Coilcraft
	1840	0402	1.9 nH	0402CS-1N9X_LU	Coilcraft
	1960 / 2140	0402	1.0 nH	0402CS-1N0X_LU	Coilcraft
	2650	0402	0 ohm	RMC1/16S-JPTH	Kamaya
L4	1485	0402	2.2 nH	0402CS-2N2X_LU	Coilcraft
	1840 / 1960 / 2140	0402	1.9 nH	0402CS-1N9X_LU	Coilcraft
	2650	0402	1.0 nH	0402CS-1N0X_LU	Coilcraft

Note: * Blocking capacitor not required in actual application circuit.

Scattering Parameters Measurement Schematic

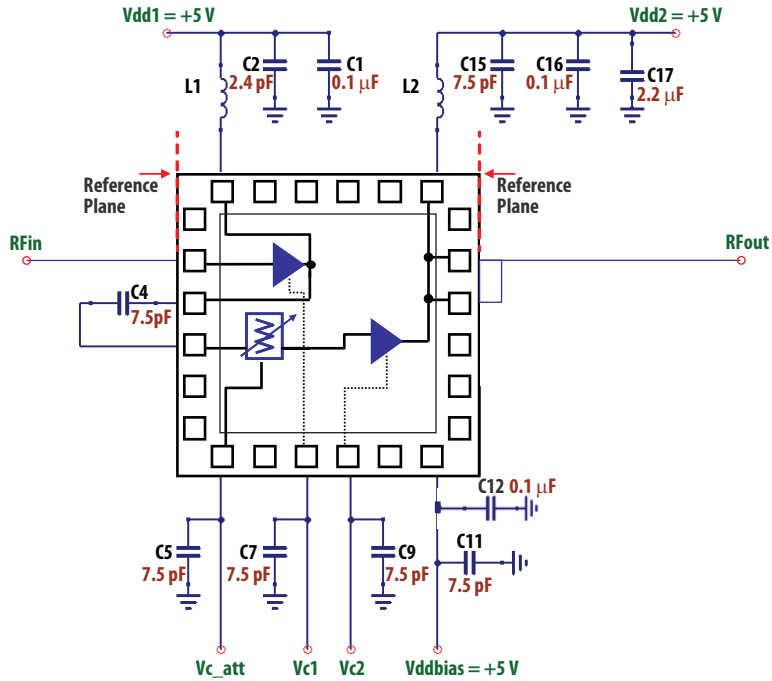

Figure 73. Scattering Parameters Measurement Schematic

Table 4. Scattering Parameters

Freq (MHz)	L1 (nH)	L2 (nH)	S11 (dB)	S11 (ang)	S21 (dB)	S21 (ang)	S12 (dB)	S12 (ang)	S22 (dB)	S22 (ang)
1485	9.0	5.6	-10.72	71.23	25.02	27.8	-59.77	-92.74	-4.22	73.69
1840 / 1960	5.6	5.6	-12.94	163.82	23.51	-97.11	-51.85	160.82	-8.02	156.35
2140	1.9	5.6	-11.37	158.91	22.40	-167.51	-47.88	108.65	-8.73	-177.21
2650	1.0	5.6	-8.42	141.80	16.59	88.91	-47.03	30.74	-3.63	178.28

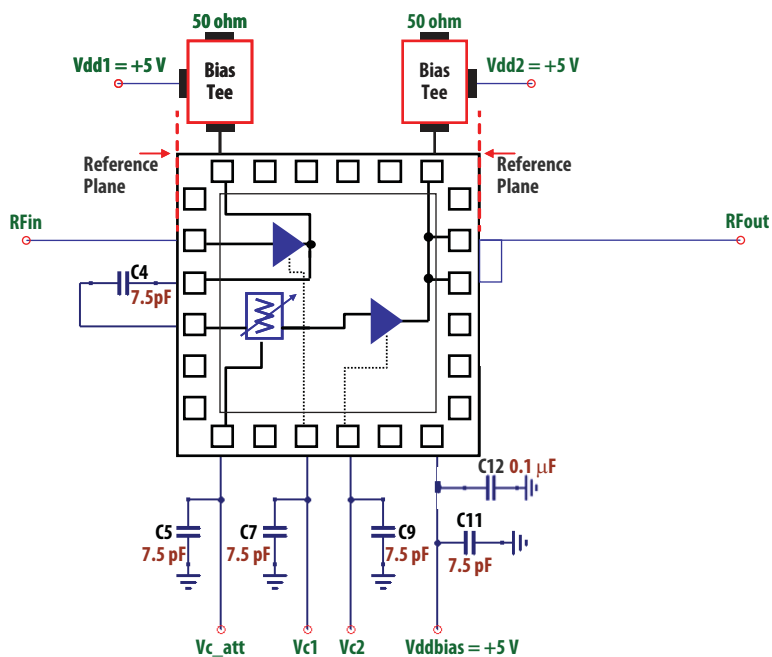

Figure 74. Broadband Scattering Parameters Measurement Schematic

Broadband Scattering Parameters

T_A = 25° C, V_{dd} = 5 V @ 390 mA, V_{c_att} = 0 V.

Table 5. Broadband Scattering Parameters

Freq (GHz)	S11 (dB)	S11 (ang)	S21 (dB)	S21 (ang)	S12 (dB)	S12 (ang)	S22 (dB)	S22 (ang)	K-Factor
0.1	-0.15	174.74	-19.59	-84.29	-50.35	-124.56	-2.48	172.57	1.33
0.2	-0.24	169.59	-14.81	-116.74	-60.20	-105.89	-2.43	172.90	1.32
0.3	-0.24	164.64	-11.82	-134.91	-53.30	91.20	-2.47	170.55	1.30
0.4	-0.16	159.79	-9.74	-151.46	-60.58	76.12	-2.56	168.24	1.32
0.5	-0.18	153.92	-8.86	-169.28	-58.53	-129.95	-2.69	165.19	1.35
0.6	-0.17	147.90	-9.91	179.40	-58.85	176.10	-2.89	161.99	1.37
0.7	-0.22	140.57	-10.88	-154.86	-59.67	107.05	-3.35	157.61	1.45
0.8	-0.27	133.45	-4.71	-132.01	-52.02	118.15	-4.25	154.89	1.54
0.9	-0.48	123.78	3.73	-138.94	-47.30	112.53	-5.85	154.28	1.64
1.0	-1.23	112.24	10.87	-173.28	-41.80	73.25	-7.28	171.62	1.56
1.5	-6.72	13.51	23.06	26.34	-35.76	-4.67	-2.49	135.98	1.03
2.0	-14.26	58.83	13.24	-132.55	-37.52	144.22	-2.08	170.71	1.19
2.5	-10.31	179.05	17.86	172.41	-44.72	39.03	-10.68	153.04	2.99
3.0	-7.60	135.55	15.86	46.95	-48.79	8.74	-2.91	174.31	1.35
3.5	-7.46	126.54	10.51	-36.77	-57.61	-33.76	-1.62	155.76	1.19
4.0	-6.98	113.14	6.96	-123.20	-64.13	-11.53	-1.34	143.37	1.16
4.5	-6.08	106.20	1.50	-167.60	-59.89	68.31	-1.95	134.83	1.25
5.0	-6.96	92.70	0.30	129.20	-58.49	67.22	-1.66	124.09	1.21
5.5	-7.40	91.38	-2.15	74.05	-56.22	94.83	-2.20	110.59	1.29
6.0	-6.94	86.79	-4.01	16.42	-54.68	74.14	-2.87	96.93	1.39
6.5	-5.34	74.29	-7.97	-45.83	-52.09	38.20	-3.98	82.92	1.58
7.0	-4.30	59.78	-6.18	-50.70	-49.44	66.89	-9.43	85.84	2.95
7.5	-3.82	46.52	-4.76	152.32	-42.01	-78.14	-5.67	103.73	1.89
8.0	-3.95	39.37	-3.62	78.93	-39.08	-148.01	-5.62	86.07	1.89
8.5	-3.65	28.51	-4.87	-34.66	-39.95	103.79	-3.48	45.97	1.46
9.0	-5.16	14.89	-21.22	134.88	-57.29	-158.37	-3.89	11.92	1.57
9.5	-6.01	10.44	-31.11	-81.49	-49.38	38.02	-5.57	-22.18	1.90
10.0	-5.32	-1.81	-18.20	84.23	-46.61	-124.71	-6.41	-55.46	2.09
10.5	-4.68	-13.51	-25.98	29.14	-49.48	168.14	-5.92	-95.79	1.98
11.0	-4.06	-23.94	-27.19	-5.31	-44.98	91.97	-5.91	-125.75	1.97
11.5	-3.75	-32.21	-26.26	-48.36	-40.95	36.99	-6.27	-149.16	2.06
12.0	-3.61	-40.81	-27.08	-100.85	-37.96	-14.04	-7.62	-169.54	2.40
12.5	-3.78	-50.19	-31.32	-148.93	-35.15	-80.36	-9.59	175.35	3.00
13.0	-3.93	-63.35	-34.03	177.13	-33.61	-138.02	-10.90	156.01	3.50
13.5	-4.32	-77.36	-31.37	172.05	-33.34	164.57	-21.71	80.39	11.97
14.0	-4.60	-88.67	-24.42	101.35	-32.14	122.35	-10.74	-129.03	3.42
14.5	-4.61	-95.93	-36.68	65.06	-39.12	37.76	-8.32	171.47	2.60
15.0	-4.25	-100.75	-33.67	73.09	-40.46	140.86	-8.03	136.71	2.52
15.5	-3.02	-107.48	-29.12	36.49	-32.63	71.82	-9.38	120.68	2.93
16.0	-2.11	-122.62	-27.58	-13.02	-31.00	15.73	-12.03	130.92	3.91
16.5	-2.00	-138.61	-27.70	-65.24	-30.69	-35.48	-11.14	153.69	3.58
17.0	-2.23	-153.52	-28.75	-117.11	-32.05	-88.63	-11.94	146.97	3.95
17.5	-2.42	-169.48	-32.44	-160.80	-36.31	-126.96	-19.64	176.08	9.49
18.0	-2.62	172.53	-35.14	176.56	-39.22	-147.58	-12.25	-142.03	4.08
18.5	-2.93	154.94	-35.55	112.11	-39.84	128.73	-15.75	-150.92	6.12
19.0	-3.18	137.14	-36.77	31.96	-42.48	36.33	-11.59	-162.42	3.79
19.5	-3.19	120.91	-38.03	-34.36	-38.82	-30.65	-9.27	162.78	2.90
20.0	-3.53	102.59	-36.22	-87.05	-34.51	-82.87	-9.34	128.95	2.93

CCDF of Dual Carrier Signal [1]

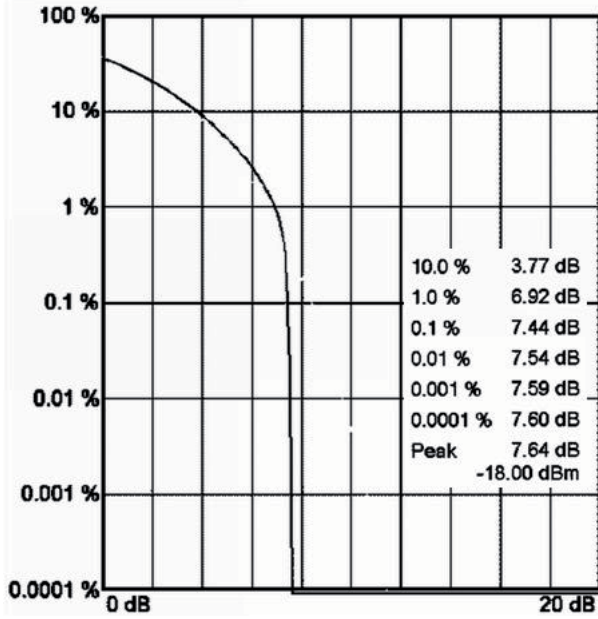
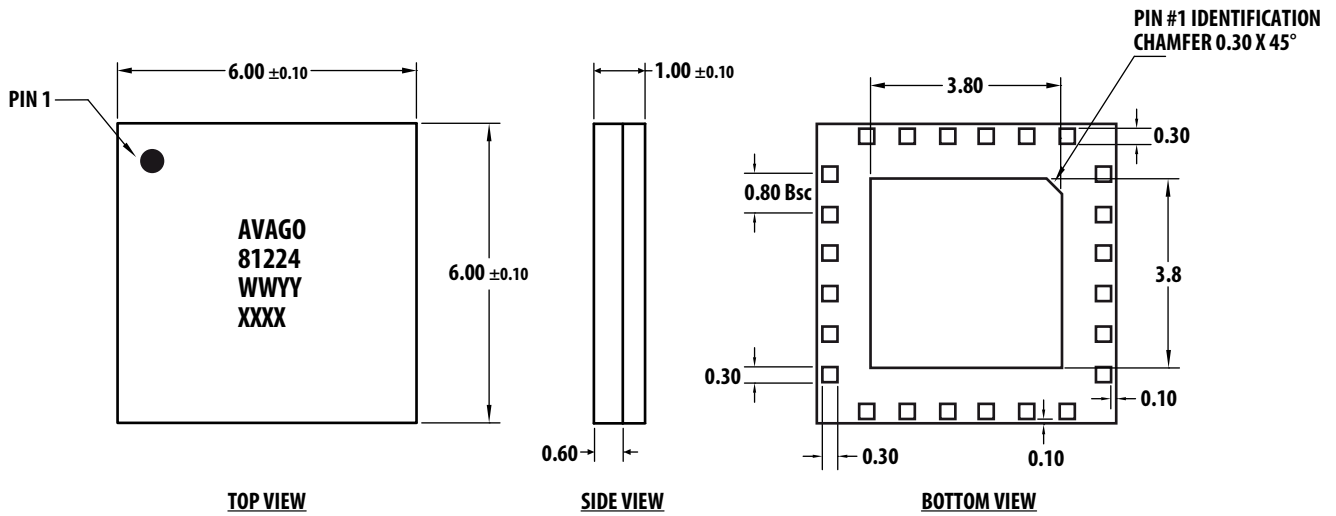

Figure 75. CCDF

Note:

1. W-CDMA modulation with 7.5 dB crest factor.

Package Dimensions



Dimensions are in millimeters.

Land Pattern and Stencil Opening Dimensions

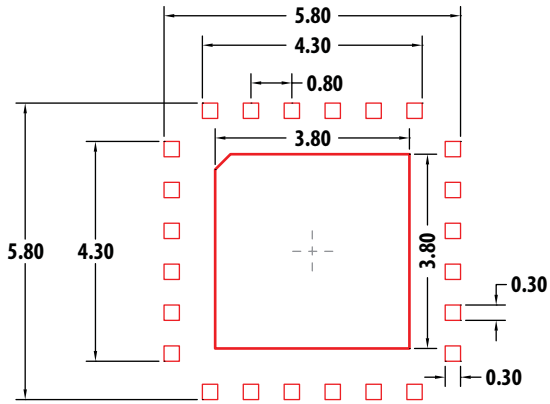

LAND PATTERN

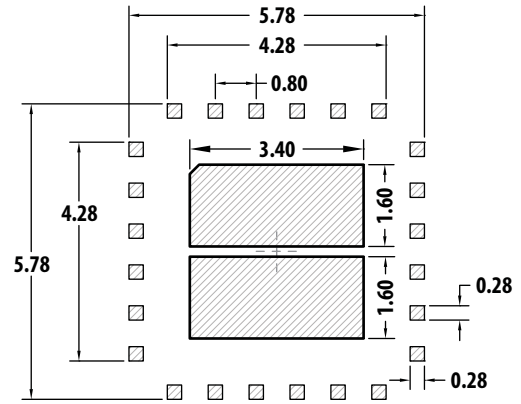

STENCIL OPENING

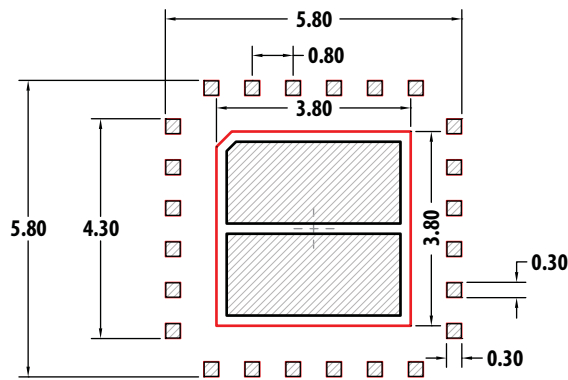

COMBINATION OF LAND PATTERN & STENCIL OPENING

Notes:

1. All dimensions are in MM
2. 0.1 mm or 4 mil stencil thickness is recommended

Device Orientation

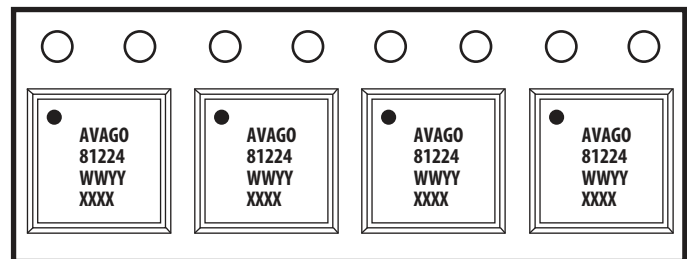
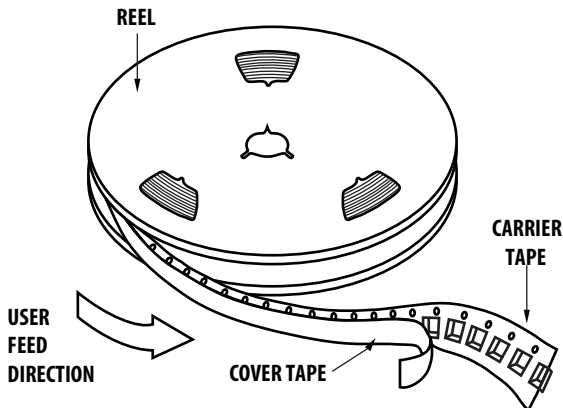

Tape Dimensions

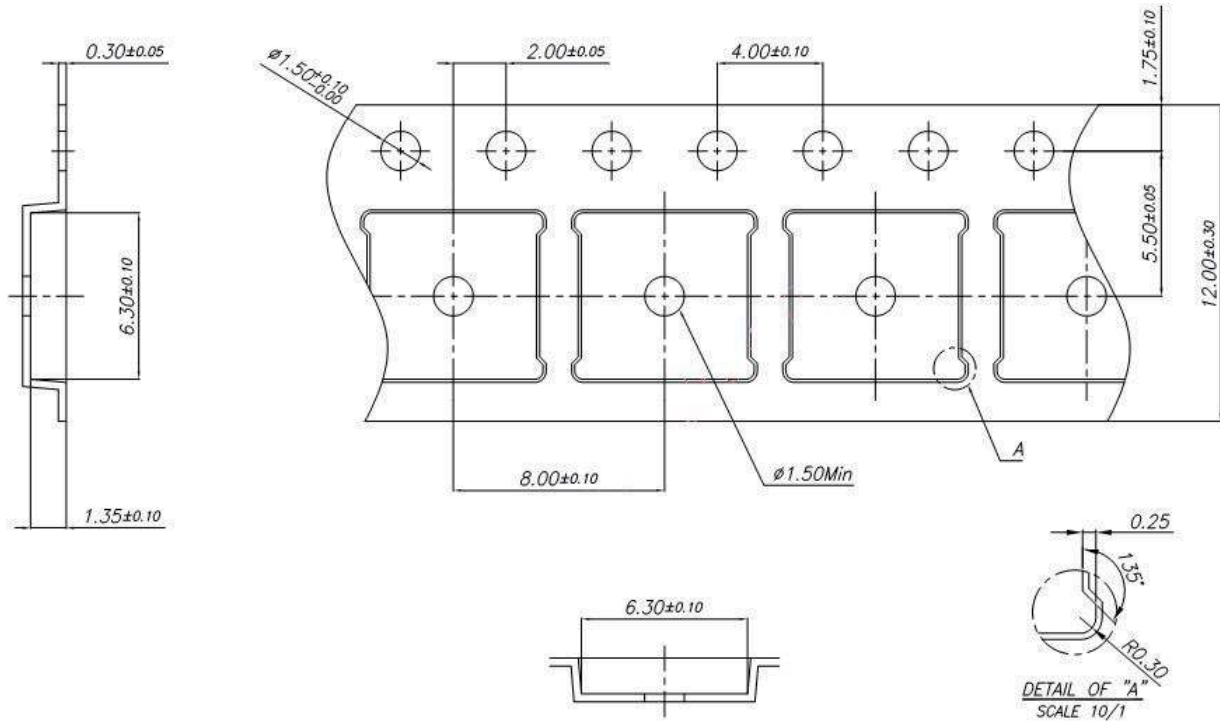

Dimensions are in millimeters.

Part Number Ordering Information

Part Number	No. of Devices	Container
ALM-81224 -BLKG	100	Antistatic Bag
ALM-81224-TR1G	3000	13" Tape/Reel

Reel Dimension – 13" Reel 12 mm Width

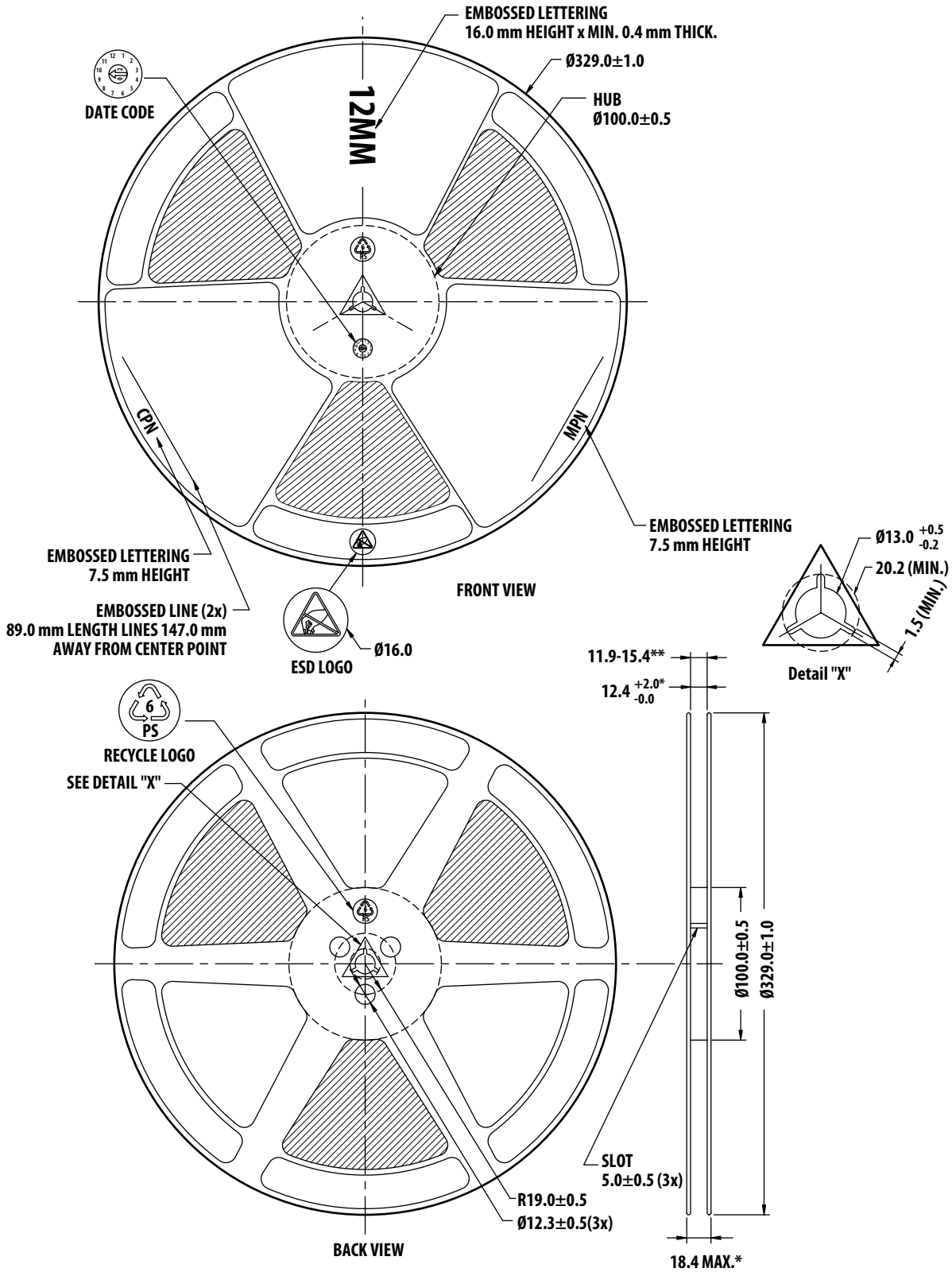

For product information and a complete list of distributors, please go to our web site: www.avagotech.com

Avago, Avago Technologies, and the A logo are trademarks of Avago Technologies in the United States and other countries.
Data subject to change. Copyright © 2005-2011 Avago Technologies. All rights reserved.
AV02-3150EN - September 19, 2011

