

TURBOSWITCH ULTRA-FAST HIGH VOLTAGE DIODE
MAIN PRODUCT CHARACTERISTICS

I_{F(AV)}	1A
V_{RRM}	600V
t_{rr} (typ)	20ns
V_F (max)	1.5V

FEATURES AND BENEFITS

- SPECIFIC TO FREEWHEEL MODE OPERATIONS : FREEWHEEL OR BOOSTER DIODE
- ULTRA-FAST AND SOFT RECOVERY
- VERY LOW OVERALL POWER LOSSES IN BOTH THE DIODE AND THE COMPANION TRANSISTOR
- HIGH FREQUENCY OPERATIONS

DESCRIPTION

The TURBOSWITCH is a very high performance series of ultra-fast high voltage power diodes. TURBOSWITCH family drastically cuts losses in both the diode and the associated switching IGBT and MOSFET in all freewheel mode operations and is particularly suitable and efficient in motor

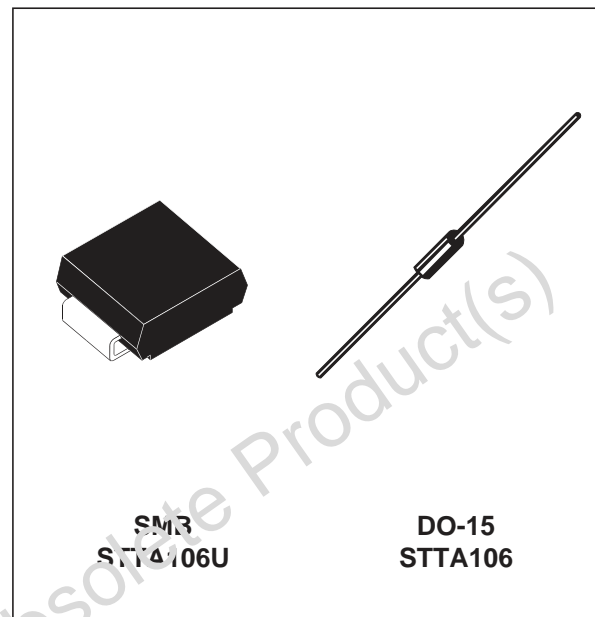

control freewheel applications and in booster diode applications in power factor control circuitries.

Available either in SMB or DO-15 axial package, these 600V devices are particularly intended for use on 240V domestic mains.

ABSOLUTE RATINGS (limiting values)

Symbol	Parameter	Value	Unit
V _{RRM}	Repetitive peak reverse voltage	600	V
i _{F(RMS)}	RMS forward current	6	A
I _{FRM}	Repetitive peak forward current	tp = 5 μs F = 5kHz square	A
I _{FSM}	Surge non repetitive forward current	tp = 10 ms sinusoidal	A
T _j	Maximum operating junction temperature	125	°C
T _{stg}	Storage temperature range	- 65 to + 150	°C

TM : TURBOSWITCH is a trademark of STMicroelectronics

STTA106/U

THERMAL AND POWER DATA

Symbol	Parameter	Test conditions	Value	Unit	
R _{th(j-l)}	Junction to lead	SMB	23	°C/W	
	Junction to lead L=5mm	DO-15	45	°C/W	
P ₁	Conduction power dissipation	I _{F(AV)} = 0.8A δ = 0.5 T _{lead} = 93°C	SMB	1.4	W
		I _{F(AV)} = 0.8A δ = 0.5 T _{lead} = 60°C	DO-15	1.4	W
P _{max}	Total power dissipation P _{max} = P ₁ + P ₃ (P ₃ = 10% P ₁)	T _{lead} = 90°C	SMB	1.5	W
		T _{lead} = 60°C	DO-15	1.5	W

STATIC ELECTRICAL CHARACTERISTICS

Symbol	Parameter	Test conditions	Min	Typ	Max	Unit
V _F *	Forward voltage drop	I _F = 1A T _j = 25°C T _j = 125°C		1.1	1.75 1.5	V
I _R **	Reverse leakage current	V _R = 0.8 x V _{RRM} T _j = 25°C T _j = 125°C		250	10 750	μA
V _{to}	Threshold voltage	I _p < 3.I _{F(AV)} T _j = 125°C			1.15	V
R _d	Dynamic resistance				350	mΩ

Test pulse : * tp = 380 μs, δ < 2%
** tp = 5 ms, δ < 2%

To evaluate the maximum conduction losses use the following equation :
 $P = V_{to} \times I_{F(AV)} + R_d \times I_{F(RMS)}^2$

DYNAMIC ELECTRICAL CHARACTERISTICS TURN-OFF SWITCHING

Symbol	Parameter	Test conditions	Min	Typ	Max	Unit
t _{rr}	Reverse recovery time	T _j = 25°C I _F = 0.5 A I _R = 1A I _{rr} = 0.25A I _F = 1 A dl _F /dt = -50A/μs V _R = 30V		20	50	ns
I _{RM}	Maximum recovery current	T _j = 125°C V _R = 400V I _F = 1A dl _F /dt = -8 A/μs dl _F /dt = -50 A/μs		1.6	0.6	A
S factor	Softness factor	T _j = 125°C V _R = 400V I _F = 1A dl _F /dt = -50 A/μs		1.1		/

TURN-ON SWITCHING

Symbol	Parameter	Test conditions	Min	Typ	Max	Unit
t _{fr}	Forward recovery time	T _j = 25°C I _F = 1 A, dl _F /dt = 8 A/μs			500	ns
V _{Fp}	Peak forward voltage	measured at 1.1 × V _F max			10	V

Fig. 1: Conduction losses versus average current.

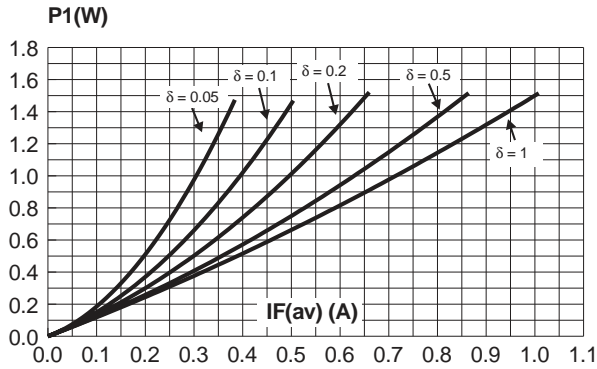

Fig. 2: Forward voltage drop versus forward current (maximum values).

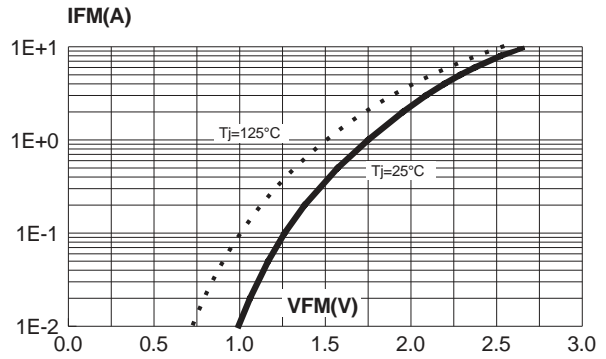

Fig. 3: Peak reverse recovery current versus dI_F/dt (90% confidence).

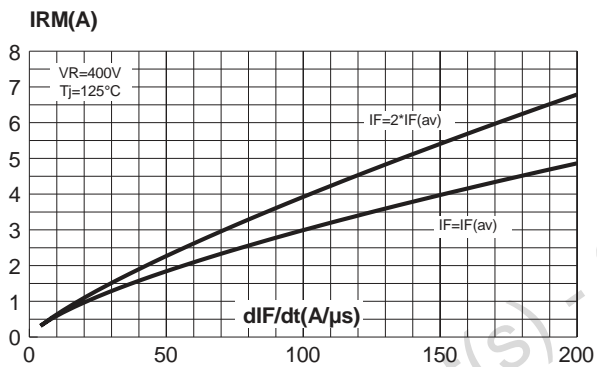

Fig. 4: Reverse recovery time versus dI_F/dt (90% confidence).

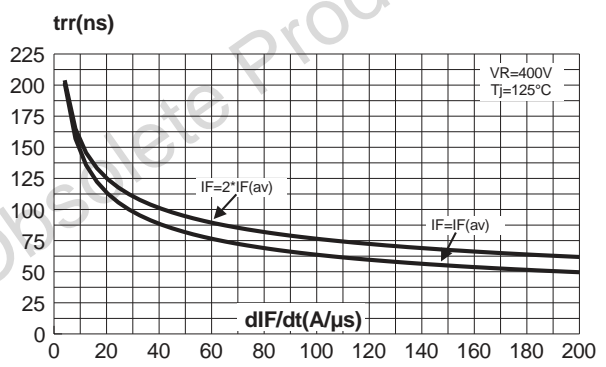

Fig. 5: Softness factor (tb/ta) versus dI_F/dt (typical values).

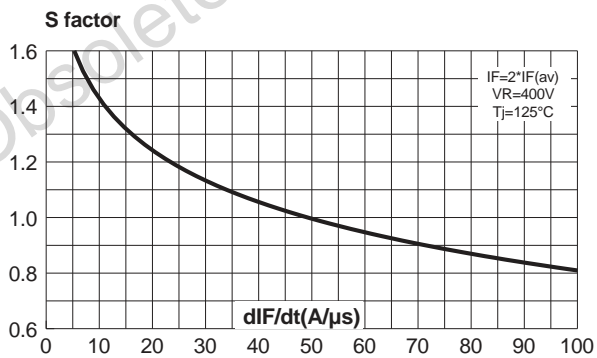

Fig. 6: Relative variation of dynamic parameters versus junction temperature (reference $T_j = 125^\circ\text{C}$). (Reference: $T_j = 125^\circ\text{C}$)

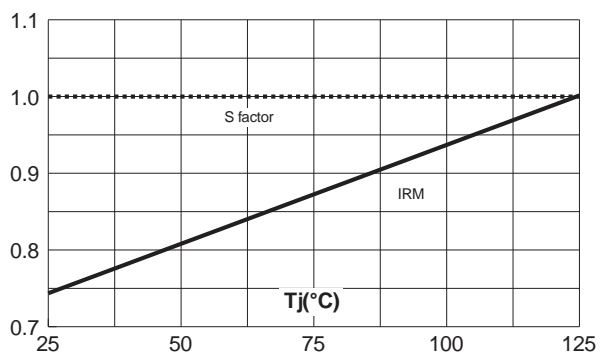

Fig. 7: Transient peak forward voltage versus dI_F/dt (90% confidence).

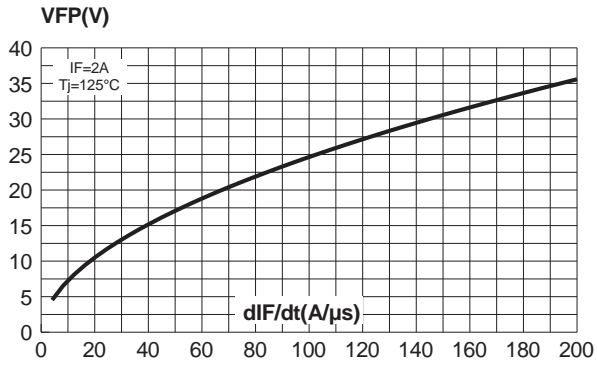

Fig. 8: Forward recovery time versus dI_F/dt (90% confidence).

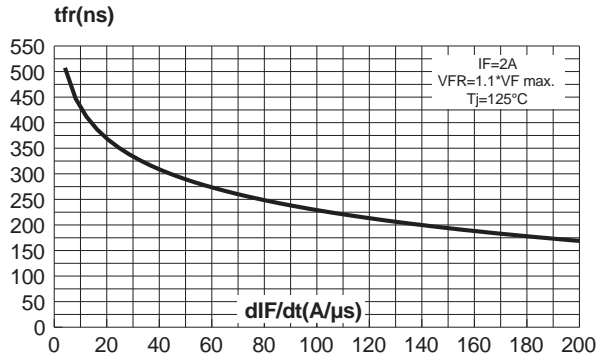
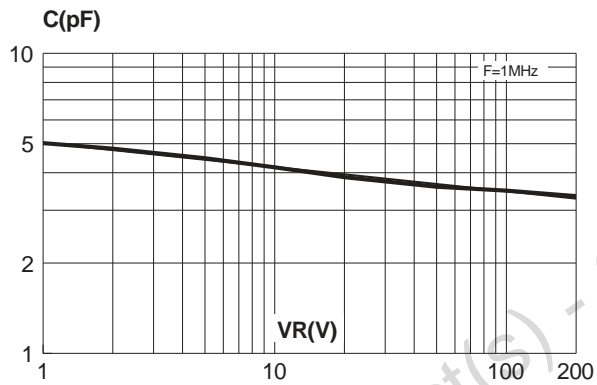

Fig. 9: Junction capacitance versus reverse voltage applied (typical values).



Obsolete Product(s) - Obsolete Product(s)

APPLICATION DATA

The TURBOSWITCH™ is especially designed to provide the lowest overall power losses in any "Freewheel Mode" application (see fig. A) considering both diode and companion transistor, thus optimizing the overall performance in the end application.

The way of calculating the power losses is given below :

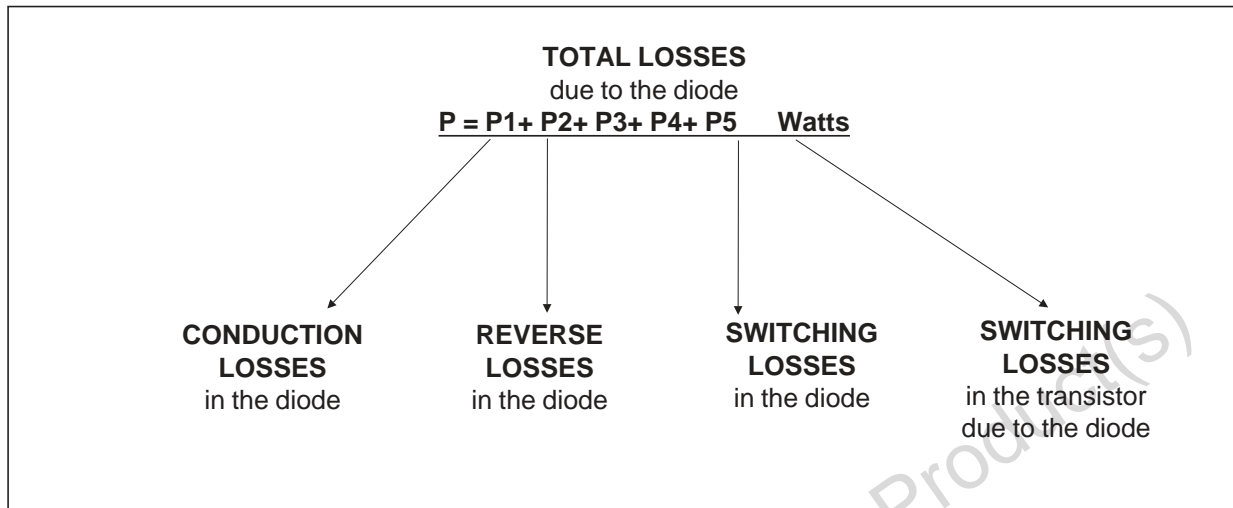
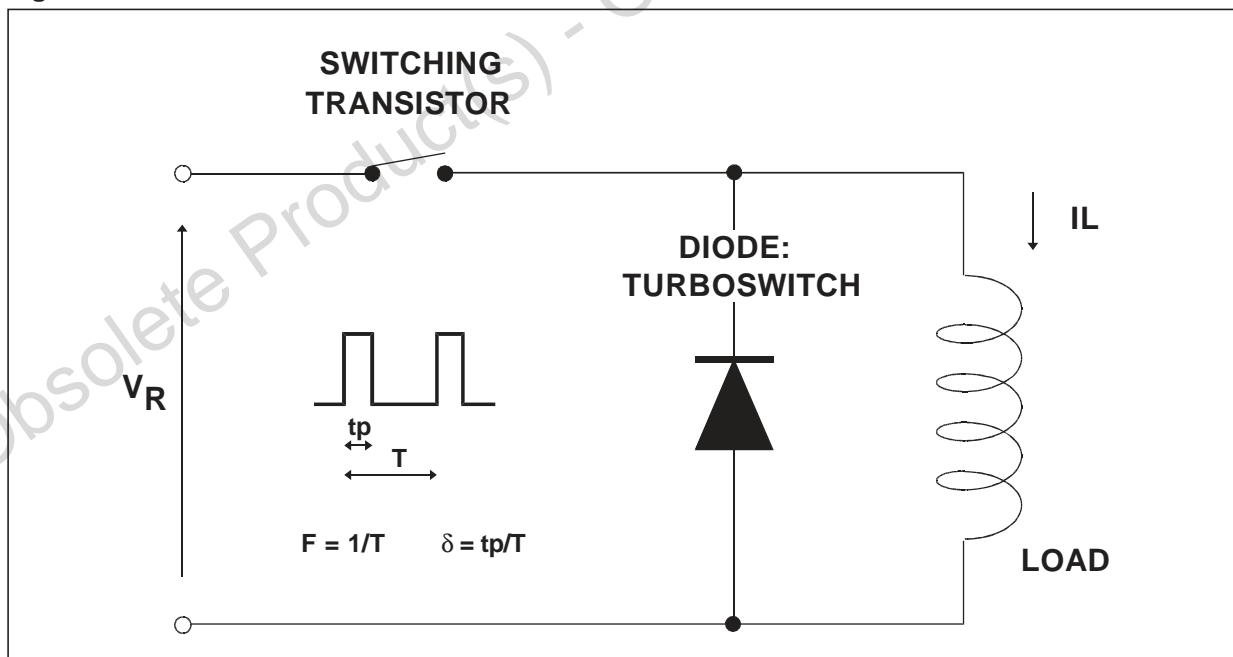
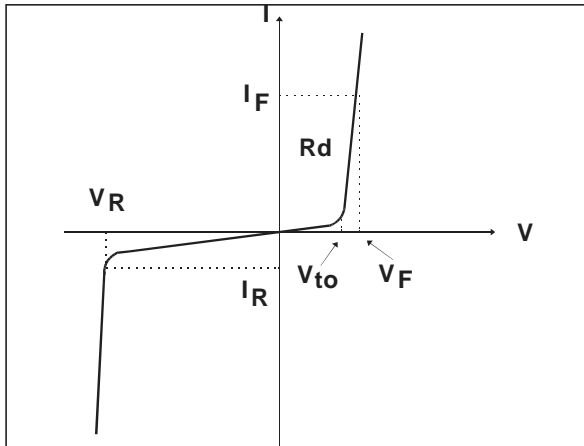

Fig. A : "FREEWHEEL" MODE



APPLICATION DATA (Cont'd)

Fig. B : STATIC CHARACTERISTICS



Conduction losses :

$$P1 = V_{to} \times I_F(AV) + R_d \times I_F^2(RMS)$$

Reverse losses :

$$P2 = V_R \times I_R \times (1 - \delta)$$

Fig. C : TURN-OFF CHARACTERISTICS

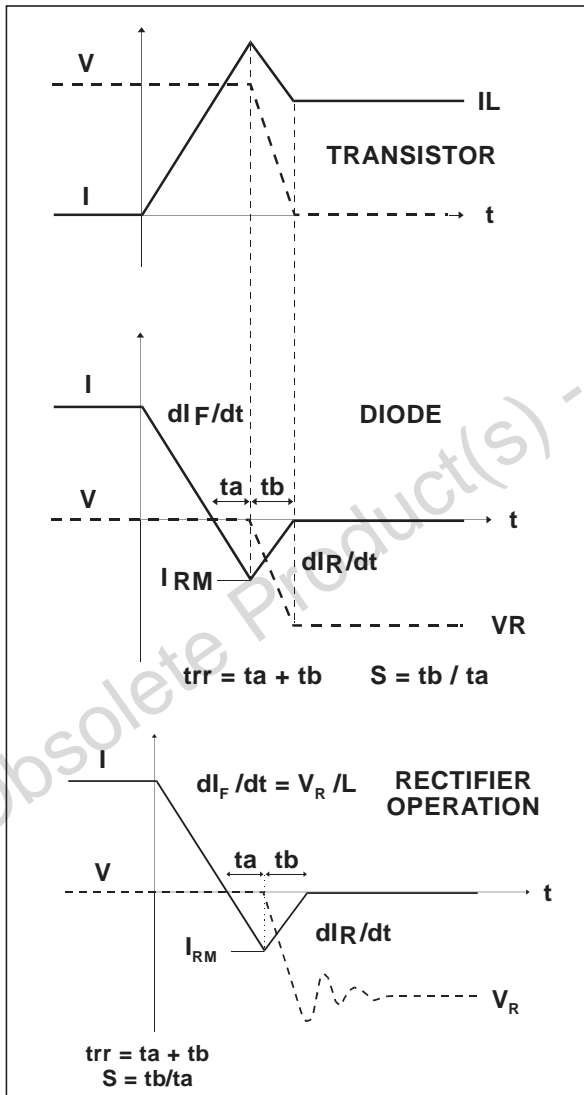

Turn-on losses :

(in the transistor, due to the diode)

$$P5 = \frac{V_R \times I_{RM}^2 \times (3 + 2 \times S) \times F}{6 \times dI_F/dt} + \frac{V_R \times I_{RM} \times I_L \times (S + 2) \times F}{2 \times dI_F/dt}$$

Turn-off losses (in the diode) :

$$P3 = \frac{V_R \times I_{RM}^2 \times S \times F}{6 \times dI_F/dt}$$

P3 and P5 are suitable for power MOSFET and IGBT

APPLICATION DATA (Cont'd)

Fig. D : TURN-ON CHARACTERISTICS

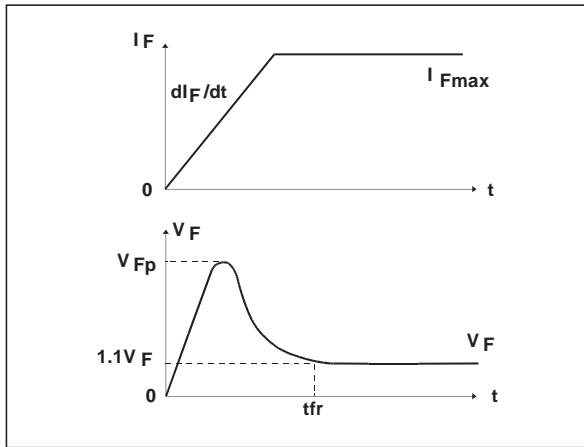

Turn-on losses :

$$P4 = 0.4 (V_{FP} - V_F) \times I_{Fmax} \times t_{fr} \times F$$

PACKAGE MECHANICAL DATA

SMB

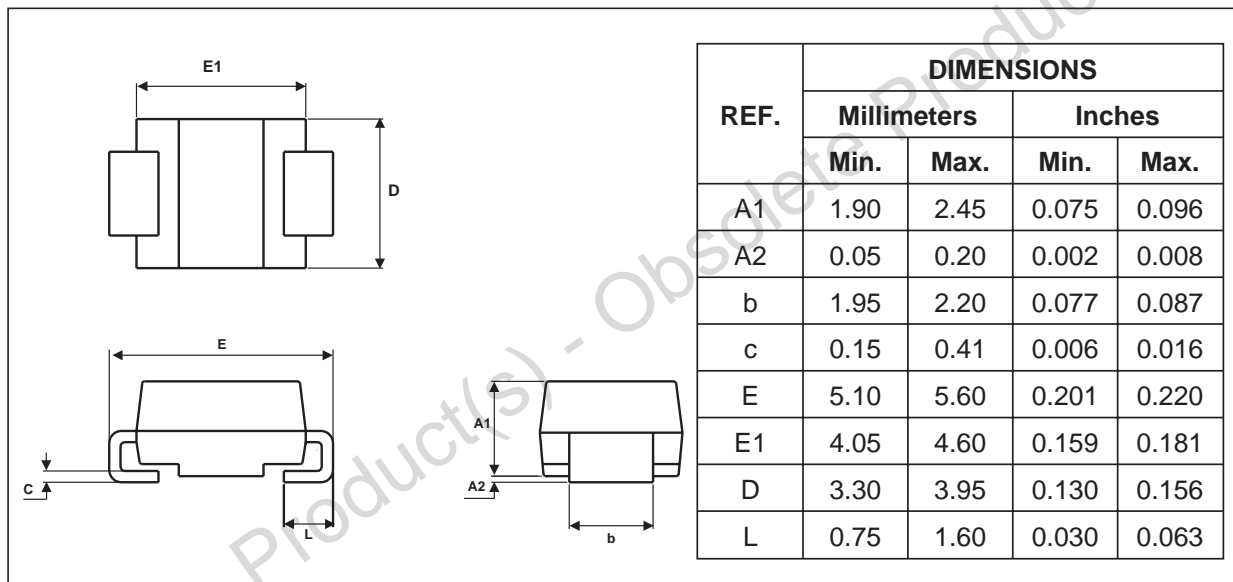

FOOTPRINT DIMENSIONS (in millimeters)

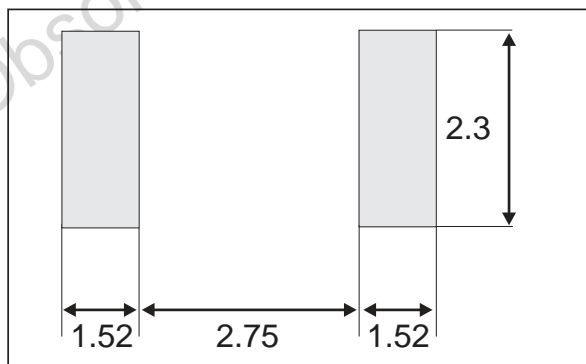

STTA106/U

PACKAGE MECHANICAL DATA

DO-15

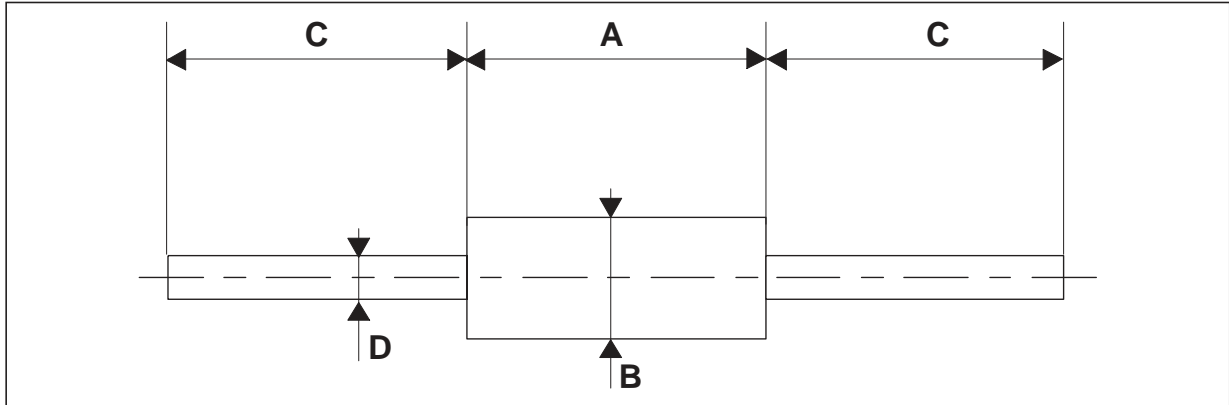

REF.	DIMENSIONS			
	Millimeters		Inches	
	Min.	Max.	Min.	Max.
A	6.05	6.75	0.238	0.266
B	2.95	3.53	0.116	0.139
C	26	31	1.024	1.220
D	0.71	0.88	0.028	0.035

MARKING

Type	Marking	Package	Weight	Base Qty	Delivery mode
STTA106U	T01	SMB	0.1 g	2500	tape & reel
STTA106	STTA106	DO-15	0.4 g	1000	Ammopack
STTA106RL	STTA106	DO-15	0.4 g	6000	tape & reel

- Band indicates cathode
- Epoxy meets UL94,V0

Information furnished is believed to be accurate and reliable. However, STMicroelectronics assumes no responsibility for the consequences of use of such information nor for any infringement of patents or other rights of third parties which may result from its use. No license is granted by implication or otherwise under any patent or patent rights of STMicroelectronics. Specifications mentioned in this publication are subject to change without notice. This publication supersedes and replaces all information previously supplied. STMicroelectronics products are not authorized for use as critical components in life support devices or systems without express written approval of STMicroelectronics.

The ST logo is a registered trademark of STMicroelectronics
 © 2001 STMicroelectronics - Printed in Italy - All rights reserved.

STMicroelectronics GROUP OF COMPANIES
 Australia - Brazil - China - Finland - France - Germany - Hong Kong - India - Italy - Japan - Malaysia
 Malta - Morocco - Singapore - Spain - Sweden - Switzerland - United Kingdom - U.S.A.

<http://www.st.com>