

1564 Series Sloped Console

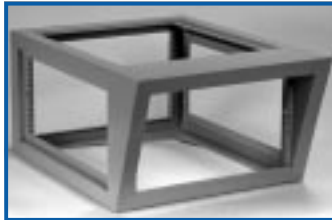

Top Console

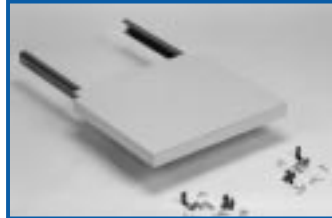

Desk



Wedge



K28

Application

- Designed to provide an attractive, durable console enclosure system for control center installations and for the protection of electronic, hydraulic, pneumatic or electrical equipment.
- The 20° viewing slope provides the optimum angle for a control or instrument panel.
- Integral CRT mounting angles and optional desk panel provide versatility for many applications.
- Can be ganged together for large system applications.

Standards

- EIA RS-310-D

Construction

- Available in Rapid Rack (2 sizes) or as a customized assembly which can be created using the various components in the 1564 Series.
- As a system rack, all components have been designed for a clean, modular interface.
- Major components are constructed of 14 gauge steel.
- Available with either 19" or 24" mounting capability.















Assemblies

- When assembling rack systems, please refer to master selection table for sizing information. 

Finish

- Rapid Rack is available in beige (CG1). Components are available in beige (CG1) or black (BK1).

Accessories

- Blowers 
- Casters 
- Desk units 
- Doors  
- Extra mounting rails 
- Fan trays 
- Filter fans 
- Side panels 
- Top consoles 
- Top panels 
- Wedges 
- 19"/24" rack mount accessories  



Rapid Rack

- For immediate delivery requirements, the *Rapid Rack* package can solve many sloped console needs. The package is finished with beige (CG1) frame and body.
- Package includes the following components and hardware:
 - 1 - 1564 frame with integral CRT mounting angles
 - 1 - pair of side panels
 - 1 - louvered rear door
 - 1 - solid top panel
 - 4 - upper black, punched combination rails
 - 4 - lower black, punched combination rails
 - 4 - adjustable levelling feet
 - 50 - 10-32 clip nuts



| PART No. | PANEL WIDTH | A | B | C | D | E | F |
|-----------|-------------|-------|------|-------|----|------|-------|
| RS4924CG1 | 19 | 22.56 | 24.5 | 19.06 | 14 | 17.5 | 21.31 |
| RS4931CG1 | 19 | 22.56 | 31.5 | 19.06 | 21 | 24.5 | 19.56 |

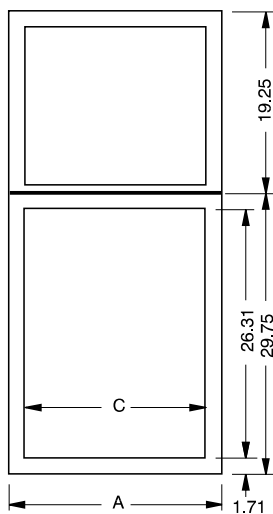
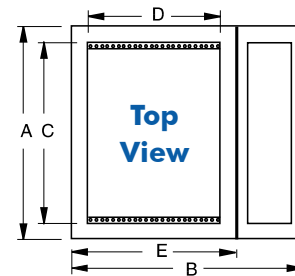

Front View

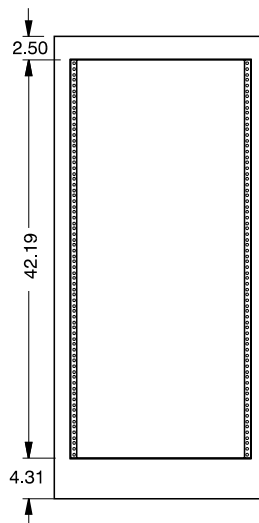

Rear View

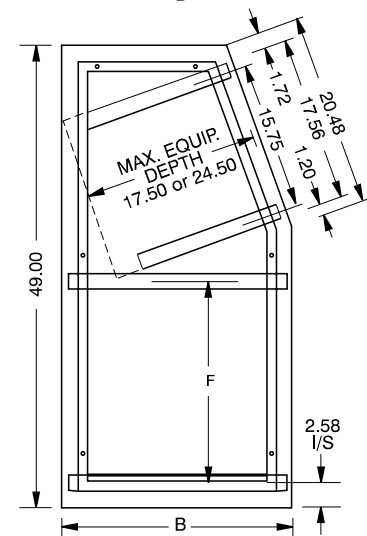

Side View

K29

All dimensions in inches unless specified otherwise

1564 Series Sloped Console Components



Frame

- The basic component of a 1564 Sloped Console system is the 14 gauge steel frame.
- Designed to accommodate standard 19" or 24" rack mountable equipment on two different panel surfaces.
- Integral CRT mounting angles are a standard feature.
- Frame comes complete with 4 upper black, punched combination rails, 4 lower black, punched combination rails, 4 adjustable levelling feet and clip nuts.
- Available in beige (CG1) or black (BK1).



| PART NO. | PANEL WIDTH | A | B | C | D | E | F |
|------------------------|-------------|-------|------|-------|----|------|-------|
| 1564A2... ¹ | 19 | 22.56 | 24.5 | 19.06 | 14 | 17.5 | 21.31 |
| 1564B2... | 19 | 22.56 | 31.5 | 19.06 | 21 | 24.5 | 19.56 |
| 1564A4... | 24 | 27.56 | 24.5 | 24.06 | 14 | 17.5 | 21.31 |
| 1564B4... | 24 | 27.56 | 31.5 | 24.06 | 21 | 24.5 | 19.56 |

¹ Specify 3 digit color code. Beige (CG1) or Black (BK1).

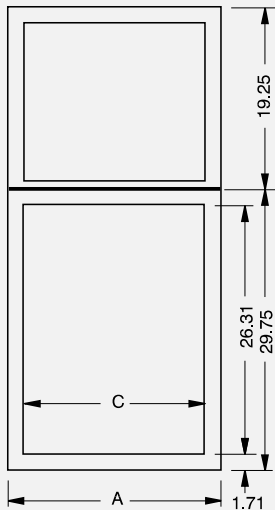
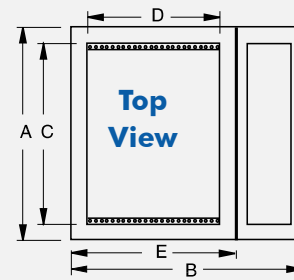

Front View

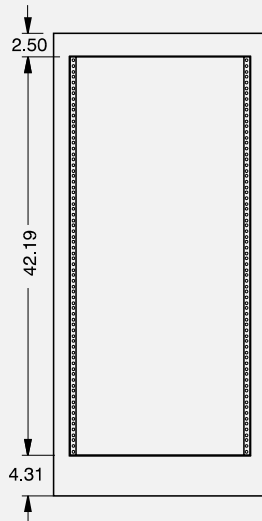

Rear View

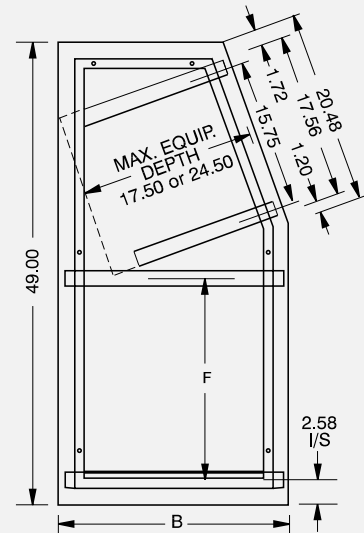

Side View

K30

All dimensions in inches unless specified otherwise



1564 Series Sloped Console Components

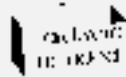

Side Panels

- Sold in pairs.
- Constructed of 16 gauge steel formed to 0.75" thick which hook over Amhal struts and can be secured from the inside.
- Panels fit flush with frame.
- Available in beige (CG1) or black (BK1).

| PART No. | USE WITH FRAME PART No. |
|------------------------|-------------------------|
| 1564AP... ¹ | 1564A2.../1564A4... |
| 1564BP... | 1564B2.../1564B4... |

¹ Specify 3 digit color code. Beige (CG1) or Black (BK1).

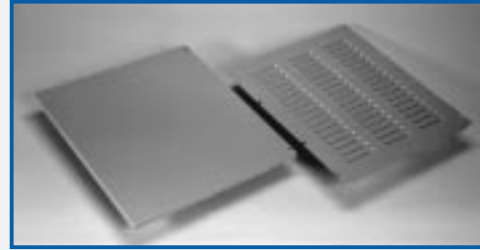

Top Panel

- Solid 16 gauge steel panel mounts flush with frame.
- Louvered 16 gauge steel panel is recessed.
- Any 19" (or 24" as applicable) panel of proper depth will fit opening.
- Available in beige (CG1) or black (BK1).
- Mounting hardware not included, please order separately.

| SOLID TOP PART No. | LOUVERED TOP PART No. | USE WITH FRAME PART No. |
|---------------------------|---------------------------|-------------------------|
| PBRS19014... ¹ | PVLK19014... ¹ | 1564A2... |
| PBRS19021... | PVLK19021... | 1564B2... |
| PBRS24014... | PVLK24014... | 1564A4... |
| PBRS24021... | PVLK24021... | 1564B4... |

¹ Specify 3 digit color code. Beige (CG1) or Black (BK1).



Rear Door

- Features lockable latch.
- Fills rear panel space and sits flush with frame.
- Solid door opens either left or right by inverting.
- Louvered door opens right hand only with louver vents facing down.
- Constructed of 18 gauge steel.
- Available in beige (CG1) or black (BK1).

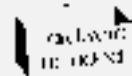

| SOLID DOOR PART No. | LOUVERED DOOR PART No. | USE WITH FRAME PART No. |
|---------------------------|---------------------------|-------------------------|
| RSDF19042... ¹ | RSDL19042... ¹ | 1564A2... |
| RSDF19042... | RSDL19042... | 1564B2... |
| RSDF24042... | RSDL24042... | 1564A4... |
| RSDF24042... | RSDL24042... | 1564B4... |

¹ Specify 3 digit color code. Beige (CG1) or Black (BK1).

K31

All dimensions in inches unless specified otherwise

1564 Series Sloped Console Components



Front Doors

- Features lockable latch.
- Fills front lower panel space and sits flush with frame.
- For optional desk units, use RSDF19022 or RSDF24022.
- Solid door opens either left or right by inverting.
- Louvered door opens right hand only with louver vents facing down.
- Available in beige (CG1) or black (BK1).

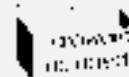

| SOLID DOOR PART No. | LOUVERED DOOR PART No. | USE W/FRAME PART No. |
|---------------------------|---------------------------|-------------------------|
| RSDF19022... ¹ | n/a | 1564A2... or 1564B2... |
| RSDF24022... | n/a | 1564A4... or 1564B4... |
| RSDF19026... | RSDL19026... ¹ | 1564A2... |
| RSDF19026... | RSDL19026... | 1564B2... |
| RSDF24026... | RSDL24026... | 1564A4... |
| RSDF24026... | RSDL24026... | 1564B4... |

¹ Specify 3 digit color code. Beige (CG1) or Black (BK1).



Wedges

- For wrap-around applications, 2 wedge sizes provide either 30° or 60° angles.
- Constructed of 14 gauge steel and comes complete with solid rear 16 gauge panel.
- Available in beige (CG1) or black (BK1).

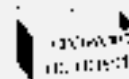

| PART No. | USE WITH FRAME PART No. | WEDGE ANGLE |
|--------------------------|----------------------------|----------------|
| 1564AW30... ¹ | 1564A2.../1564A4... | 30 |
| 1564BW30... | 1564B2.../1564B4... | 30 |
| 1564AW60... | 1564A2.../1564A4... | 60 |
| 1564BW60... | 1564B2.../1564B4... | 60 |

¹ Specify 3 digit color code. Beige (CG1) or Black (BK1).

K32

1564 Master Selection Table

| PANEL WIDTH | CABINET DEPTH | FRONT PANEL HEIGHT | | SLOPE PANEL HEIGHT | | SIDE PANELS (PAIR) | WEDGE | | TOP PANEL | | |
|----------------|------------------|-----------------------|-------|-----------------------|-------|--------------------------|------------------------|--------------------------|--------------------------|---------------------------|---------------------------|
| | | INCHES | UNITS | INCHES | UNITS | | FRAME | 30° | 60° | SOLID | LOUVERED |
| 19" | 24.5 | 26.25 | 15 | 17.5 | 10 | 1564A2... ¹ | 1564AP... ¹ | 1564AW30... ¹ | 1564AW60... ¹ | PBRS19014... ¹ | PVLK19014... ¹ |
| | | 31.5 | 15 | 17.5 | 10 | 1564B2... | 1564BP... | 1564BW30... | 1564BW60... | PBRS19021... | PVLK19021... |
| 24" | 24.5 | 26.25 | 15 | 17.5 | 10 | 1564A4... | 1564AP... | 1564AW30... | 1564AW60... | PBRS24014... | PVLK24014... |
| | | 31.5 | 15 | 17.5 | 10 | 1564B4... | 1564BP... | 1564BW30... | 1564BW60... | PBRS24021... | PVLK24021... |

¹ Specify 3 digit color code. Beige (CG1) or Black (BK1).

All dimensions in inches unless specified otherwise



1564 Series Sloped Console Components

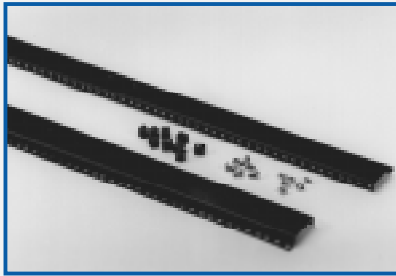

Photo shows combination rails

Extra Mounting Rails

- Rails are sold in **pairs**.
- Available as **punched** combination (same as supplied with 1564 rack), panel and accessory rails.
- All rails have full EIA panel mounting (0.28" dia.) for ¼-20 bolts or 10-32 clip nuts.
- Each rail is adjustable in a 1.0" x 0.281" slot.
- Constructed of 14 gauge and finished in black.
- Clip nuts are provided with rails.

| PART No. | PANEL HEIGHT OF RACK | |
|---------------------|----------------------|-------|
| | INCHES | UNITS |
| RSR_00017BK3 | 17.50 | 10 |
| RSR_00026BK3 | 26.25 | 15 |

" - Specify rail type in blank space.
(C) Combination, (A) Accessory, (P) Panel

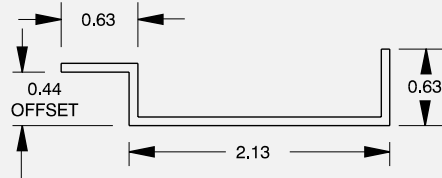

Combination Rails

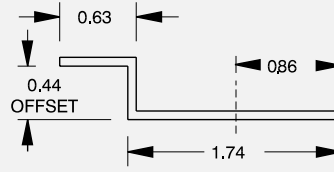

Accessory Rails



Panel Rails



Castors

- Casters supplied in a set of 4.
- Features a manufacturer's specified capacity of 400 lbs. per set.
- Constructed of twin nylon swivel wheels with zinc axles and hoods.
- Wheel has a 2.37" diameter with a final mounting height of 2.75".
- 5/16-18 threaded stem mounts into existing holes in base.

| PART No. | 1425P |
|----------|-------|
|----------|-------|

K33

| DOOR | | | | TOP CONSOLE | | | |
|---------------------------|---------------------------|---------------------------|---------------------------|----------------------------|---------------------------|---------------------------|---------------------------|
| REAR | | FRONT | | FLUSH SOLID | | SIDE | TILT |
| SOLID | LOUVERED | SOLID | LOUVERED | FRAME | TOP PANEL | PANELS (PAIR) | BASE |
| RSDF19042... ¹ | RSDL19042... ¹ | RSDF19026... ¹ | RSDL19026... ¹ | 1564TC1917... ¹ | PBRS19014... ¹ | 1564TCP17... ¹ | 564CB1917... ¹ |
| RSDF19042... | RSDL19042... | RSDF19026... | RSDL19026... | 1564TC1924... | PBRS19021... | 1564TCP24... | 1564CB1924... |
| RSDF24042... | RSDL24042... | RSDF24026... | RSDL24026... | 1564TC2417... | PBRS24014... | 1564TCP17... | 1564CB2417... |
| RSDF24042... | RSDL24042... | RSDF24026... | RSDL24026... | 1564TC2424... | PBRS24021... | 1564TCP24... | 1564CB2424... |

All dimensions in inches unless specified otherwise