

## TYPICAL INDICATOR ORDERING EXAMPLE

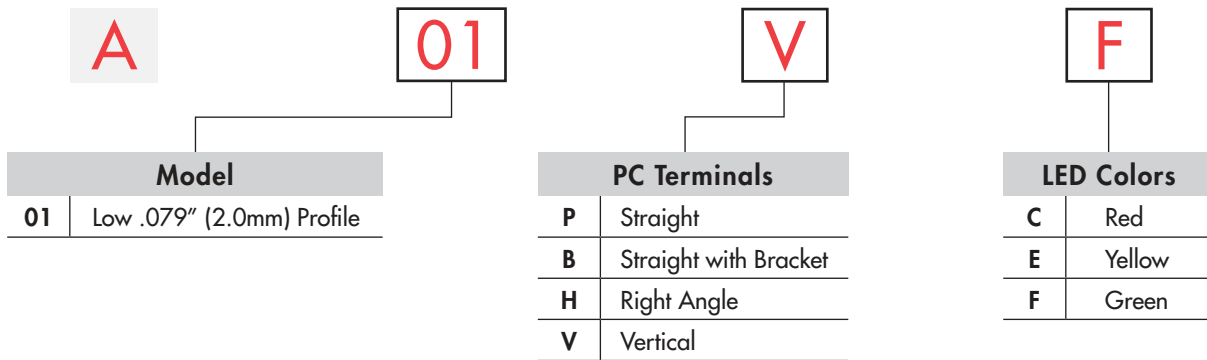

DESCRIPTION FOR TYPICAL ORDERING EXAMPLE

**A01VF**

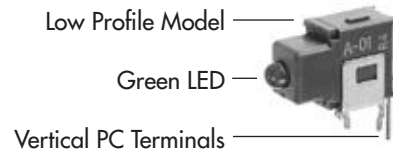

## PC TERMINALS

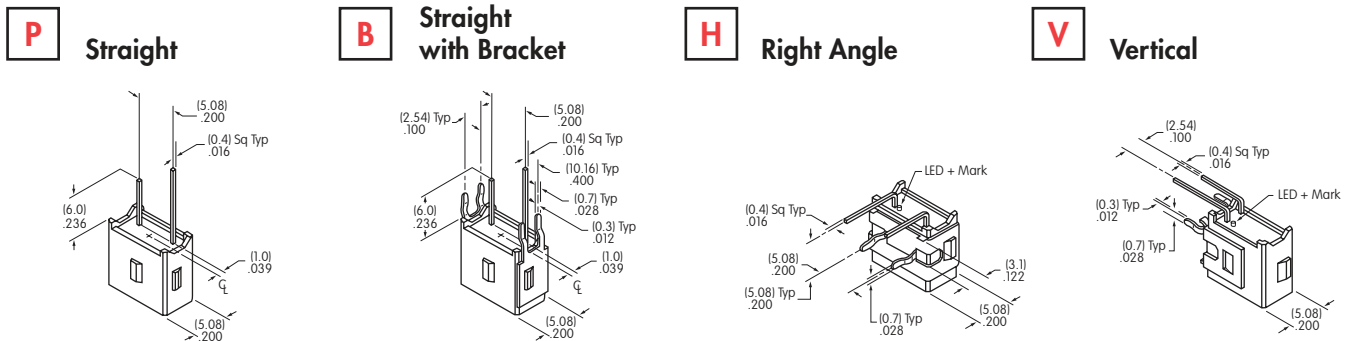

## LED COLORS & SPECIFICATIONS

		<b>A01</b> Indicator		
		<b>C</b>	<b>E</b>	<b>F</b>
LED is colored in OFF state	Color	Red	Yellow	Green
Maximum Forward Current	$I_{FM}$	50mA	50mA	50mA
Typical Forward Current	$I_F$	30mA	30mA	30mA
Forward Voltage	$V_F$	1.7V	2.2V	2.1V
Maximum Reverse Voltage	$V_{RM}$	4V	4V	4V
Current Reduction Rate Above 25°C	$\Delta I_F$	0.67mA/°C	0.67mA/°C	0.67mA/°C
Ambient Temperature Range		-30°C ~ +85°C		

Electrical specifications are determined at a basic temperature of 25°C.  
 If the source voltage is greater than the LED's rated voltage, a ballast resistor must be connected in series with the LED.  
 The ballast resistor value can be calculated by using the formula shown in the Supplement section.

Toggle  
 Rockers  
 Pushbuttons  
 Illuminated PB  
 Programmable  
 Keylocks  
 Rotaries  
 Slides  
 Tactiles  
 Tilt  
 Touch  
 Indicators  
 Accessories  
 Supplement

## TYPICAL INDICATOR DIMENSIONS

### Straight PC

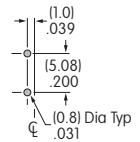
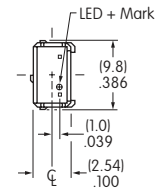
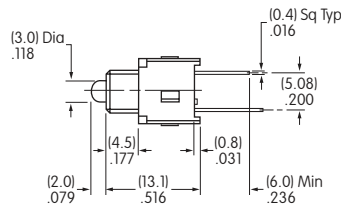
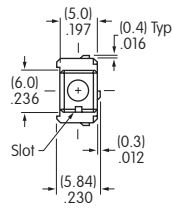

**A01PF**

### Straight PC • Bracket

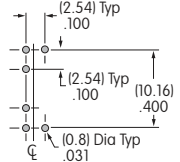
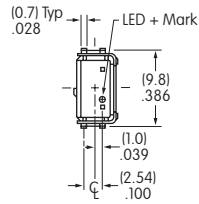
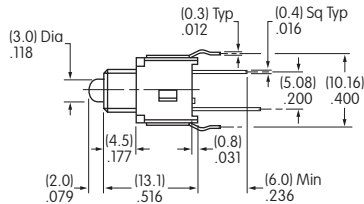
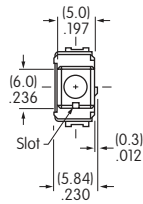

**A01BF**

### Right Angle PC

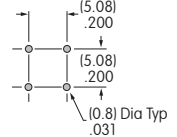
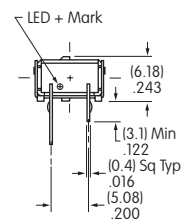
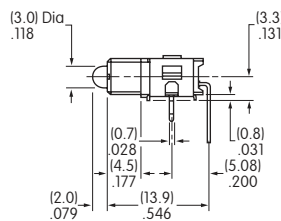
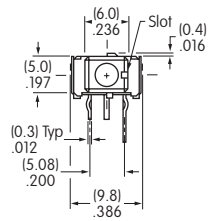

**A01HF**

### Vertical PC

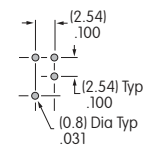
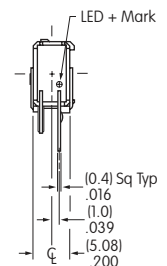
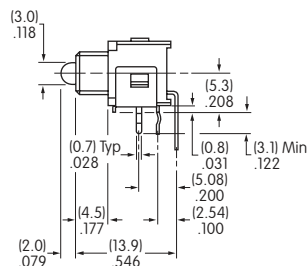
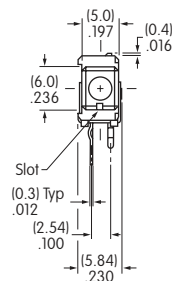

**A01VF**

Toggles  
Rockers  
Pushbuttons  
Illuminated PB  
Programmable  
Keylocks  
Rotaries  
Slides  
Tactiles  
Tilt  
Touch  
Indicators  
Accessories  
Supplement