

④ **USB 2.0 COMPLIANT**

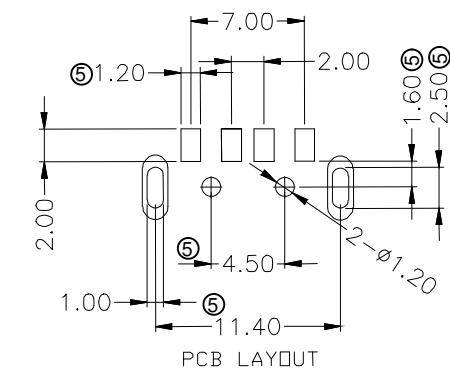
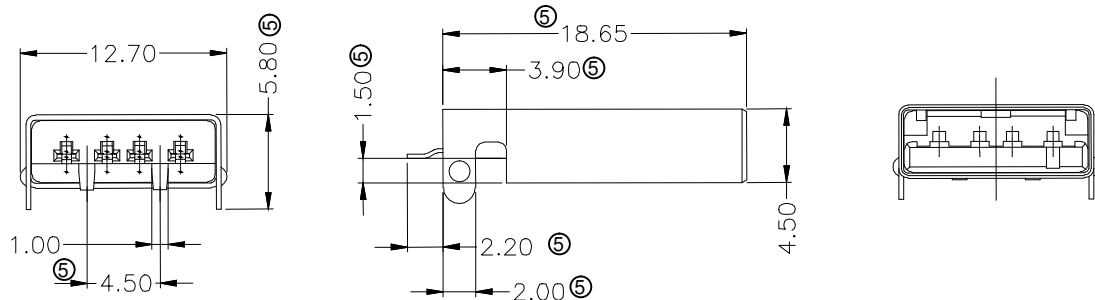
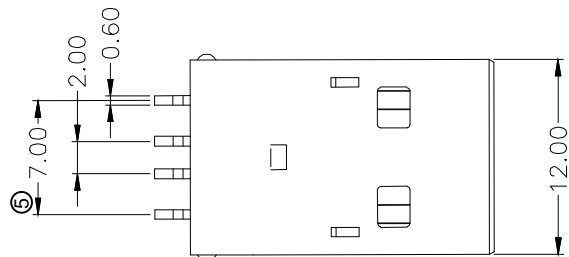

**NOTES:**  
**MATERIAL:**

⑤ 1. Insulation: LCP UL94V-0, Color as below:  
A-USB A-LP-SMT-C-xx

NONE: White  
BK: Black ⑥

2. Contact : Brass

3. Plating : Selective Gold Flash over 50µ" Nickel

⑤ 4. Shell Plating: SPCC , 50µ" Nickel

5. Packing: 100pcs/Tray

⑤ **MECHANICAL:**

1. MATING FORCE:3.57KG MAX

2. UNMATING FORCE:1.02KG MIN

3. DURABILITY:1500 CYCLES MIN

⑤ **ELECTRICAL:**

1. CURRENT RATING:1.5A

2. DIELECTRIC STRENGTH: 500V AC FOR 1MINUTE

3. CONTACT RESISTANCE: 30MΩ MAX

4. INSULATION RESISTANCE: 1000MΩ MIN

⑦ **OPERATING TEMPERATURE: -55°C TO +90°C**

**RoHS compliant**

Unit: mm

| Scale            | Free  | ⑦   | Update operating temperature   | 26.07.2021 | Luca |          | Date       | Name    |
|------------------|-------|-----|--------------------------------|------------|------|----------|------------|---------|
| <b>TOLERANCE</b> |       | ⑥   | Add new PN for black insulator | 17.07.2020 | Luca | Drawn    | 25.03.2006 | Hellwig |
| .X               | ±0.30 | ⑤   | Update to new spec and page 2  | 06.03.2018 | Tom  | Approved | 26.07.2021 | Luca    |
| .XX              | ±0.20 | ④   | Add USB 2.0 compliant          | 27.08.2013 | Ray  |          |            |         |
| .XXX             | ±0.10 | ③   | Correct the packing            | 22.03.2011 | Rale |          |            |         |
| DIM              | TOL   | ②   | Update                         | 07.07.2009 | Dean |          |            |         |
| X.°              | ±5°   |     |                                |            |      |          |            |         |
| Angle            | TOL   |     |                                |            |      |          |            |         |
| UNIT             | mm    | Id. | Modification                   | Date       | Name |          |            |         |
|                  |       |     |                                |            |      |          |            |         |

|  |             |
|--|-------------|
| Description: <b>USB 2.0</b>                |             |
| <b>A TYPE/MALE/SMT</b>                     |             |
| ASSMANN WSW-No. <b>A-USB A-LP-SMT-C-xx</b> |             |
| Drawing-No. <b>ASS 1452A CO</b>            | rev07       |
| Customer-No.                               | SHEET 1 / 2 |



**USB 2.0 COMPLIANT**

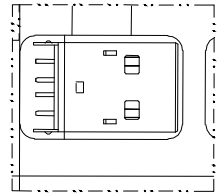

5:1

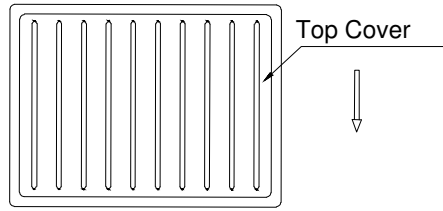

Top Cover

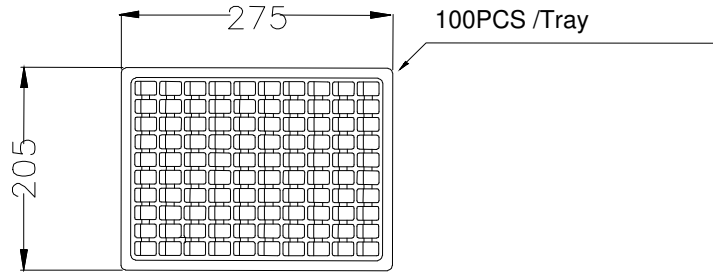

100PCS /Tray

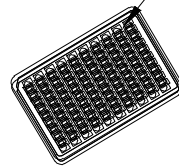
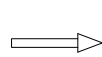

40 trays /carton



drying agent

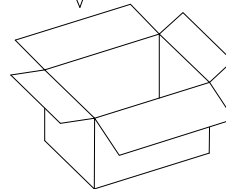

Label

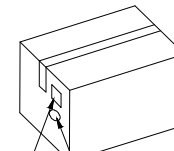

RoHS Label

NOTES:

Packing quantity :4KPCS / Carton .  
Carton Size: 49\*29\*19cm

**RoHS compliant**

Unit: mm

| Scale            | Free  | ⑦   | Update operating temperature   | 26.07.2021 | Luca |          | Date       | Name    |
|------------------|-------|-----|--------------------------------|------------|------|----------|------------|---------|
| <b>TOLERANCE</b> |       | ⑥   | Add new PN for black insulator | 17.07.2020 | Luca | Drawn    | 25.03.2006 | Hellwig |
| .X               | ±0.30 | ⑤   | Update to new spec and page 2  | 06.03.2018 | Tom  | Approved | 26.07.2021 | Luca    |
| .XX              | ±0.20 | ④   | Add USB 2.0 compliant          | 27.08.2013 | Ray  |          |            |         |
| .XXX             | ±0.10 | ③   | Correct the packing            | 22.03.2011 | Rale |          |            |         |
| DIM              | TOL   | ②   | Update                         | 07.07.2009 | Dean |          |            |         |
| X.°              | ±5°   | Id. | Modification                   | Date       | Name |          |            |         |
| Angle            | TOL   |     |                                |            |      |          |            |         |
| UNIT             | mm    |     |                                |            |      |          |            |         |

Description: USB 2.0  
A TYPE/MALE/SMT

ASSMANN WSW-No.  
A-USB A-LP-SMT-C-xx

Drawing-No.  
ASS 1452A CO rev07

Customer-No. SHEET 1 / 2

