

EVK-W262U

Evaluation kit for ODIN-W2 series

User Guide

Abstract

This document describes how to set up the EVK-W262U evaluation kit to evaluate u-blox ODIN-W2 series with UART communication.



www.u-blox.com

UBX-15020900 - R04

Document Information	
Title	EVK-W262U
Subtitle	Evaluation kit for ODIN-W2 series
Document type	User Guide
Document number	UBX-15020900
Revision, date	R04 26-May-2017
Disclosure restriction	

This document applies to the following products:

Product name	Type number	Firmware version	PCN reference
EVK-W262U	EVK-W262U-00	1.0.0	N/A

u-blox reserves all rights to this document and the information contained herein. Products, names, logos and designs described herein may in whole or in part be subject to intellectual property rights. Reproduction, use, modification or disclosure to third parties of this document or any part thereof without the express permission of u-blox is strictly prohibited.

The information contained herein is provided "as is" and u-blox assumes no liability for the use of the information. No warranty, either express or implied, is given, including but not limited, with respect to the accuracy, correctness, reliability and fitness for a particular purpose of the information. This document may be revised by u-blox at any time. For most recent documents, please visit www.u-blox.com.

Copyright © 2017, u-blox AG.

u-blox® is a registered trademark of u-blox Holding AG in the EU and other countries.

Contents

Contents.....	3
1 Introduction.....	4
1.1 Overview	4
1.1.1 Features.....	4
1.1.2 System requirements.....	4
1.1.3 Specifications.....	5
1.2 Block diagram.....	5
1.3 Connectors.....	5
1.4 LEDs	5
1.5 System modes	6
1.6 Buttons.....	6
2 Getting started	7
2.1 Software installation.....	7
2.2 Hardware installation.....	7
2.3 Basic operations using s-center	7
2.3.1 Connect to the ODIN-W2.....	7
2.3.2 Using the s-center.....	8
2.3.3 Get and set configuration	9
2.3.4 Basic Bluetooth operation	10
2.3.5 Basic Wi-Fi operation	12
2.4 Further information	12
2.5 Restoring default factory settings.....	13
Appendix	14
A List of acronyms	14
Related documents.....	15
Revision history.....	15
Contact.....	16

1 Introduction

This document describes how to set up the u-blox EVK-W262U evaluation kit to evaluate the ODIN-W2 series modules with UART communication.

1.1 Overview

The ODIN-W2 is a compact and powerful stand-alone multiradio module, designed for Internet-of-Things gateway applications. The module includes embedded Bluetooth® stack, Wi-Fi driver, IP stack, and an application for wireless data transfer, all configurable using AT commands. The wireless support includes dual-mode Bluetooth v4.0 (BR/EDR and low energy) and dual-band Wi-Fi (2.4 and 5 GHz bands).

The EVK-W262U evaluation kit enables easy evaluation of the u-blox ODIN-W2 series stand-alone IoT gateway modules. All configurations are handled over a single USB interface that provides both power supply and high-speed data transfer thus eliminating the need for an external power supply. A powerful software tool is also included so evaluation can start immediately. The u-blox EVK-W262U evaluation kit is compact and mobile and does not require any cables or extra antennas. Its user friendly interface makes it ideally suited for use in laboratories and vehicles alike.

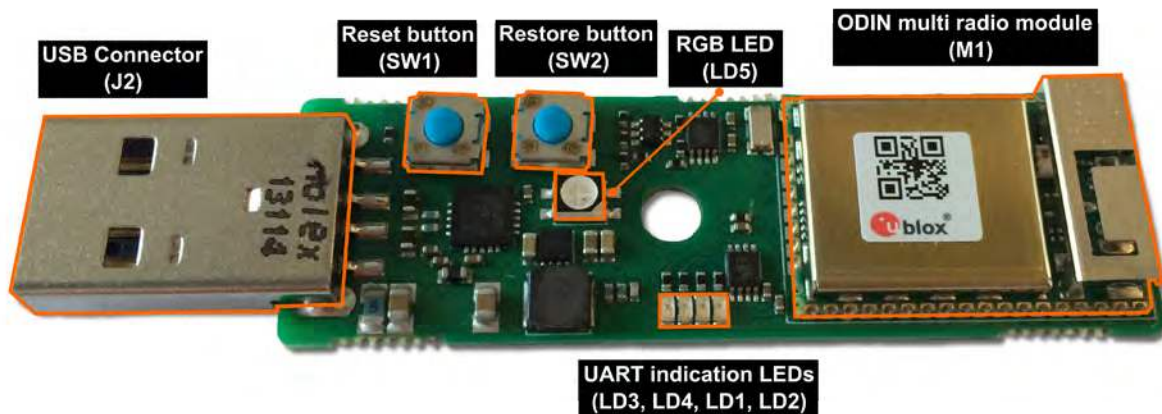

Figure 1: Overview of EVK-W262U evaluation kit

1.1.1 Features

- ODIN-W262 multiradio module with internal antenna
- USB 2.0 connector for virtual COM port interface and power
- 5 LED indicators for status and activity
- Reset button for quick rebooting
- Factory restore button for easy recovery from non-standard settings

1.1.2 System requirements

- PC with USB interface
- Operating system: Windows Vista, 7, 8, and 10
- Internet connection for downloading the FTDI driver

1.1.3 Specifications

Parameter	Specification
Serial Interfaces	1 USB 2.0
Dimensions	55.5 x 17.0 mm
Power Supply	5 V through USB
Normal Operating Conditions	-40 °C to +65 °C

Table 1: EVK-W262U specifications

1.2 Block diagram

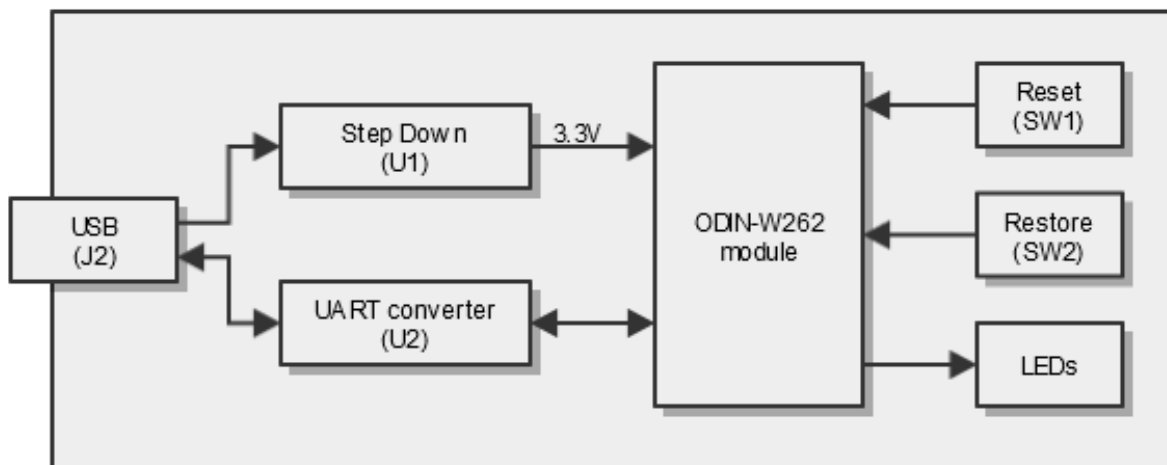

Figure 2: Block diagram of main components of EVK-W262U

The EVK-W262U evaluation kit uses only one USB interface to communicate with the evaluation software and for power supply. A DC/DC step down voltage converter (U1) supplies the ODIN module with a 3.3 V system voltage. To transform the USB data signals to a common UART interface used by the module, a UART converter chip (U2) is used. To help in the evaluation process, a reset and system restore button is featured as well as five LEDs to indicate system status.

1.3 Connectors

A USB 2.0 compatible serial port is featured for data communication and power supply.

Function	Description	Name
UART over USB	USB Type A connector, power source and interface for sending AT commands	J2

Table 2: Available connectors in EVK-W262U

1.4 LEDs

The evaluation board has five LEDs to indicate status of system and communication link. The LEDs LD1 to LD4 are located on the side of the PCB and indicate when the UART signals TXD, RXD, RTS and CTS are active as shown in Table 3. The LD5 is an RGB LED located in the middle of the board that changes color according to the current system mode.

Function	Description	Name	Color
TXD	Blinks when data is being transmitted to the PC	LD2	Yellow
RXD	Blinks when data is being received from the PC	LD1	Green
RTS	Lit when the UART RTS signal is asserted	LD4	Yellow
CTS	Lit when the UART CTS signal is asserted	LD3	Green
Mode	RGB diode indicates the current system mode	LD5	RGB

Table 3: Available LED indicators and their functions

1.5 System modes

The ODIN-W2 series modules can enter different modes of operation. The EVK includes an RGB LED to indicate the current mode. See *ODIN-W2 AT Commands manual* [1] for more information about the modes.

Mode	Status	RGB LED color
Data mode	IDLE	Green
AT mode	IDLE	Orange
Data or AT mode	CONNECTING ¹	Purple
Data or AT mode	CONNECTED ¹	Blue

Table 4: Different operational modes

1.6 Buttons

The evaluation board has two push-buttons located at the edge of the PCB as shown in **Figure 1**. Pressing the Reset button will force a reset of the host CPU on the ODIN module. The Restore button will, in combination with a reset, restore the settings of the serial interface and the current AT-configuration to its factory default as described in the **Restoring default factory settings** section.

Function	Description	Name
Reset host	Forced reset of the host CPU	SW1
Restore factory settings / External connect	Restores all the factory settings of the ODIN-W262 module ² / External input for multiple use, see the ODIN-W2 AT Commands manual [1] for detailed use.	SW2

Table 5: Available push-buttons on the evaluation board



Be careful not to damage the electrical components through electrostatic discharge.

¹ The LED will flash in this state indicating data activity

² Restore function is enabled during startup. After starting up, SW2 is used as External connect.

2 Getting started



Internet connection is required for downloading the FTDI driver in the EVK-W262U evaluation kit.

2.1 Software installation

The EVK-W262U can be used together with the s-center software tool. The s-center software tool can be downloaded from u-blox website. Download and run the executable. The software components will be installed on your system and placed under the "u-blox" folder in the "Start -> All Programs" menu.

2.2 Hardware installation



Connecting the unit to a USB powered hub is not recommended. The unit may draw more power than the USB hub can supply, thus resulting in a power failure in all connected USB devices.

1. Connect the unit to a PC running Microsoft Windows through an empty USB port.
2. If connected to the internet, the operating system will install the correct drivers automatically. The drivers will only need to be installed the first time you connect the unit to a new computer.
3. A COM port will automatically be assigned to the unit by Windows. On Windows 7, open the Control Panel, click Hardware and Sound and click Device Manager to view the assigned COM ports.

2.3 Basic operations using s-center

2.3.1 Connect to the ODIN-W2

Start the s-center evaluation software and assigned COM port of the unit using the default settings as mentioned in Table 6. Refer to the *ODIN-W2 User Guide* [4] for more information.

Parameter	Configuration
USB Virtual COM port	115200 baud, 8 data bits, no parity, 1 stop bit, hardware flow control

Table 6: Default settings for the virtual COM port

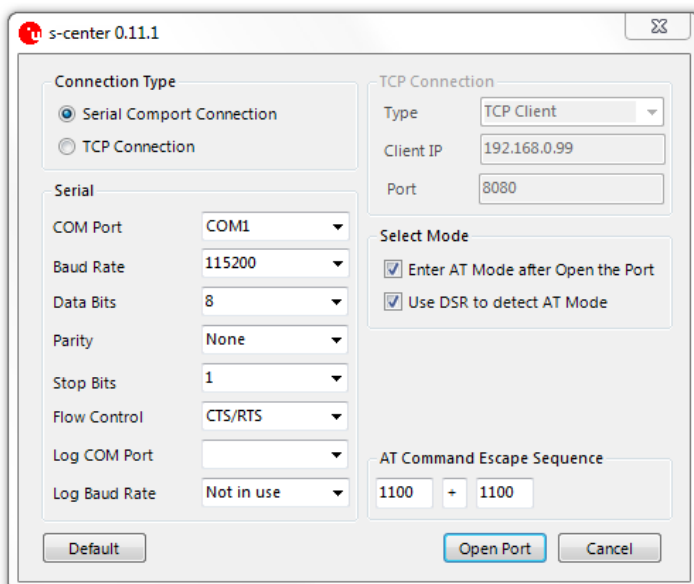

Figure 3: COM port settings in s-center

2.3.2 Using the s-center

Once you establish connection with the COM port, the main screen will be shown. The Basic Connection tab enables you to perform some simple tasks like finding other devices and setting up connections.

The s-center will start up by trying to set the module in AT-Mode. If successful, it will read out the basic information like Bluetooth, Wi-Fi address, and firmware version.

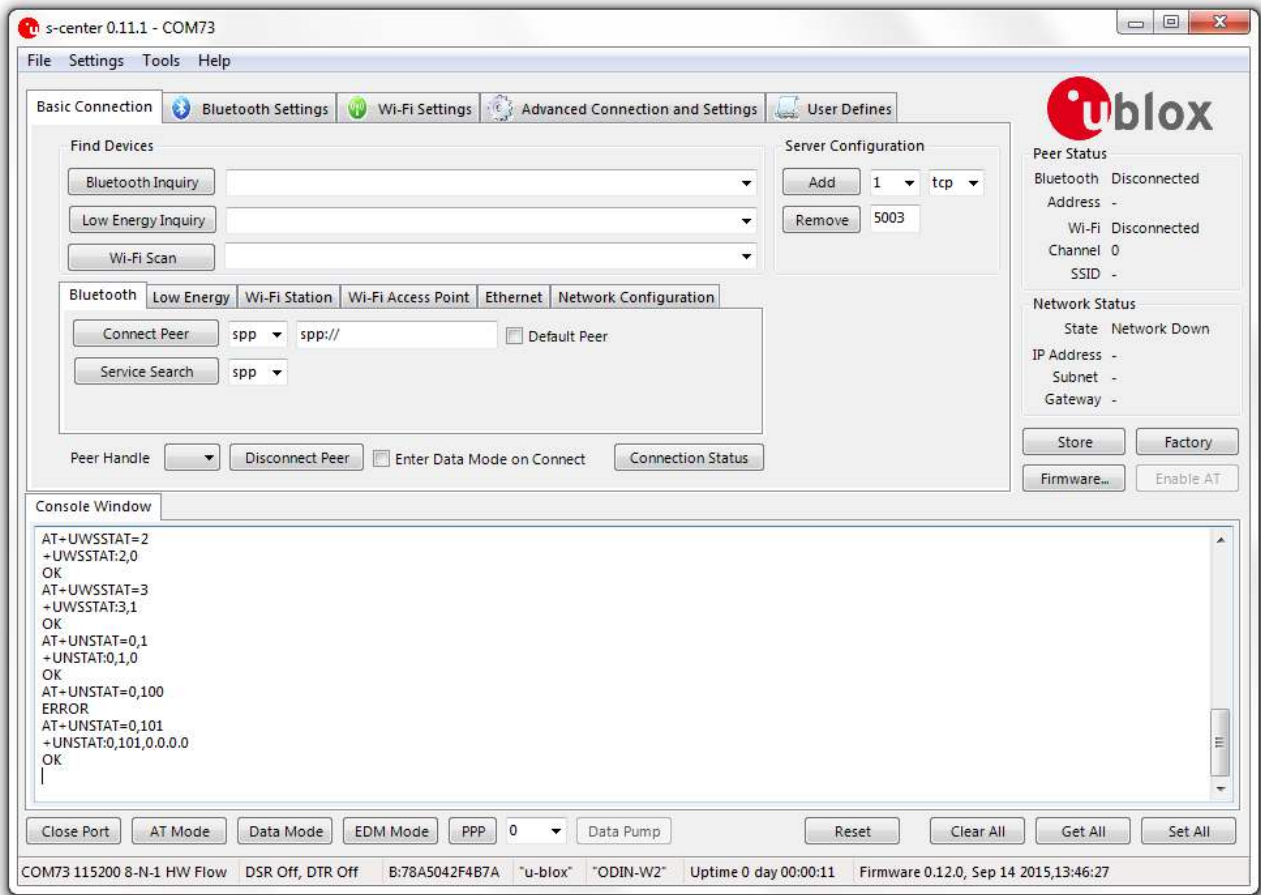

Figure 4: Main screen in s-center

2.3.3 Get and set configuration

The Get All and Set All are used to get and set a complete configuration to the ODIN-W2.



Nothing will be stored in flash until the *Store* button is clicked. That will store the current configuration into the flash of the ODIN-W2 and will be used when the module starts up after a reset. Some commands like +UWSCA stores the settings without the need of using the *Store* button.

Use the *Factory* Button if you need a complete reset (of the configuration).

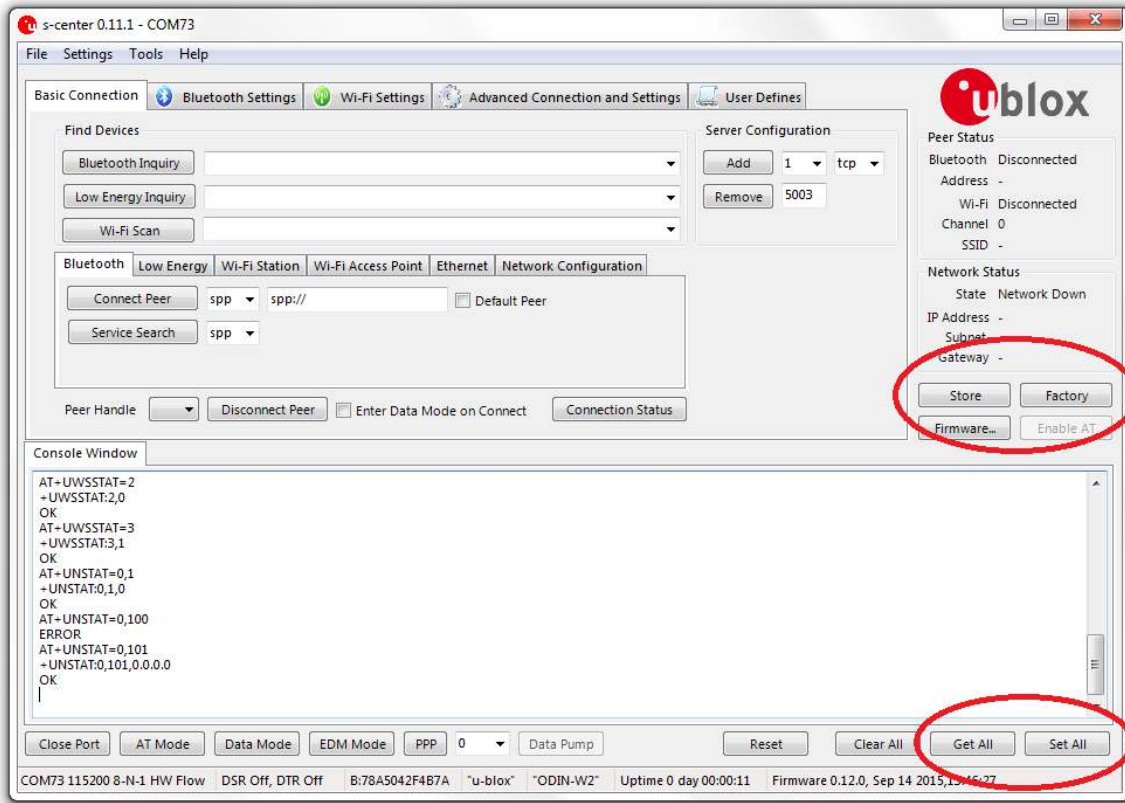

Figure 5: Main screen in s-center

2.3.4 Basic Bluetooth operation

Finding other units

Clicking the Bluetooth Inquiry initiates a search for other Bluetooth devices and the results are shown after 5 seconds.

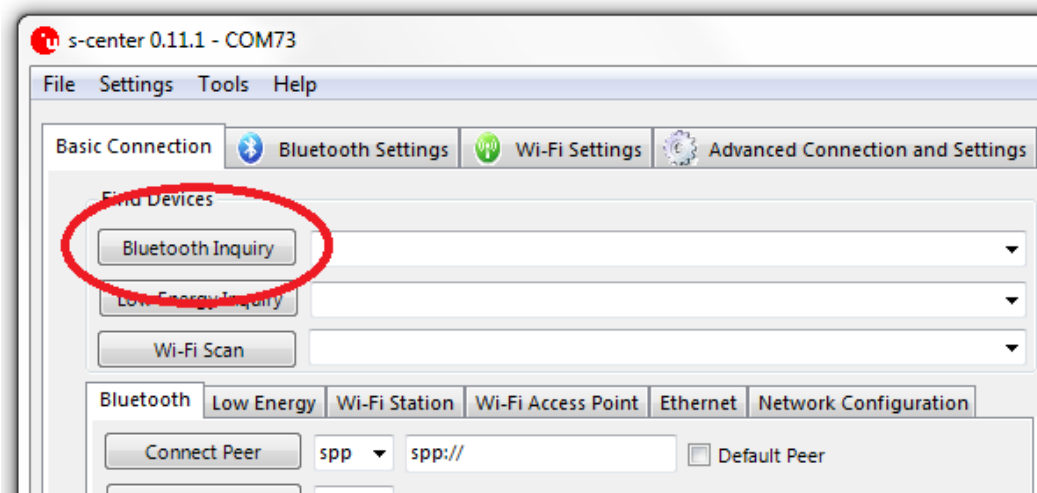

Figure 6: Bluetooth inquiry in s-center

Select device

If the s-center finds some Bluetooth devices, it will be shown in the list as shown in Figure 7.

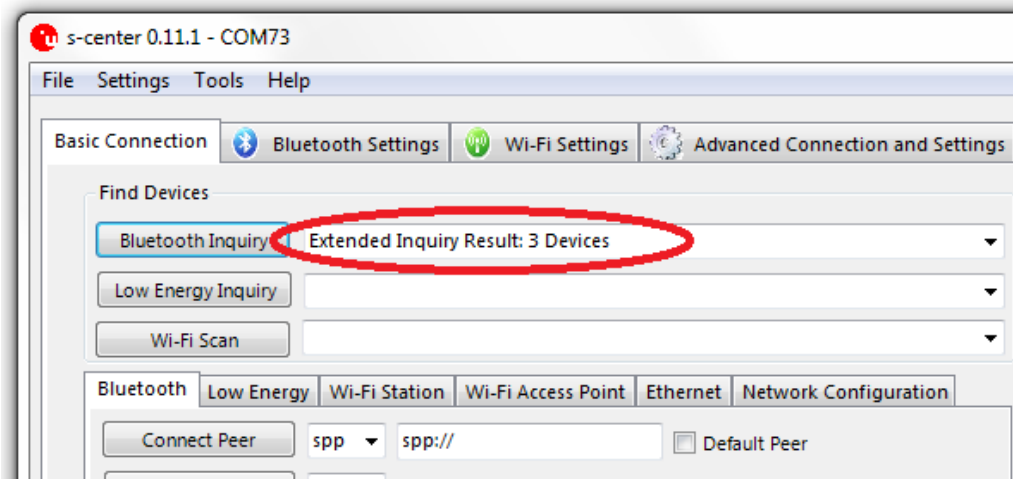

Figure 7: Response to Bluetooth inquiry in s-center

Connect to device

Select the device you want to connect to and press Connect Peer to establish a connection. If the other device is also an ODIN-W2, it accepts and establishes the connection. If there are other devices, some actions must be taken.

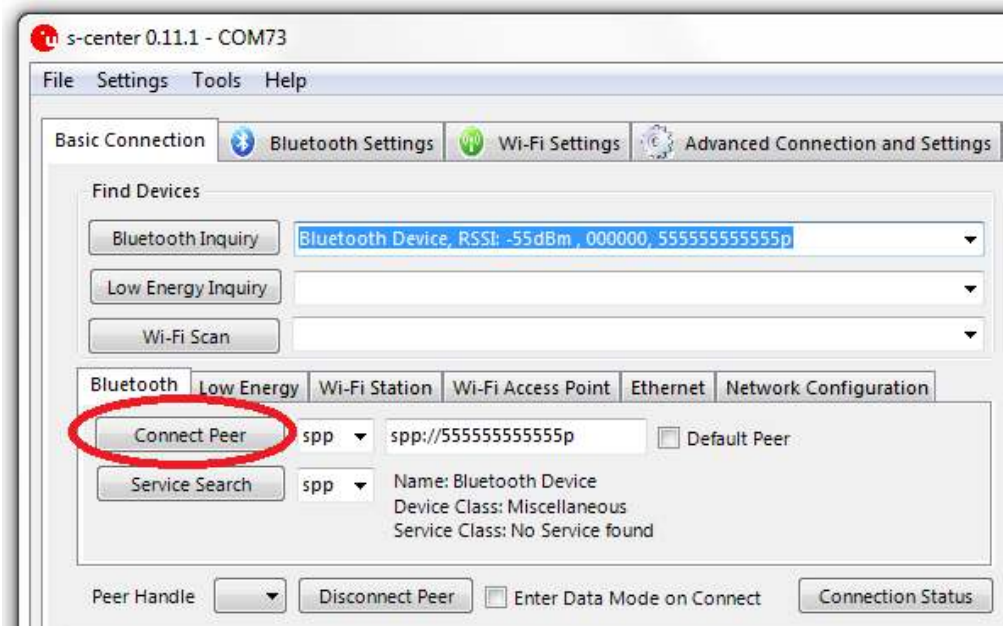

Figure 8: Connecting to peer in s-center

Send data to other device

The easiest way is to enter data mode by clicking the Data Mode button or type ATO1. All the data that is typed in the console window is sent to the other device.



If ODIN-W2 is in AT-Mode it is unable to send or receive any data.

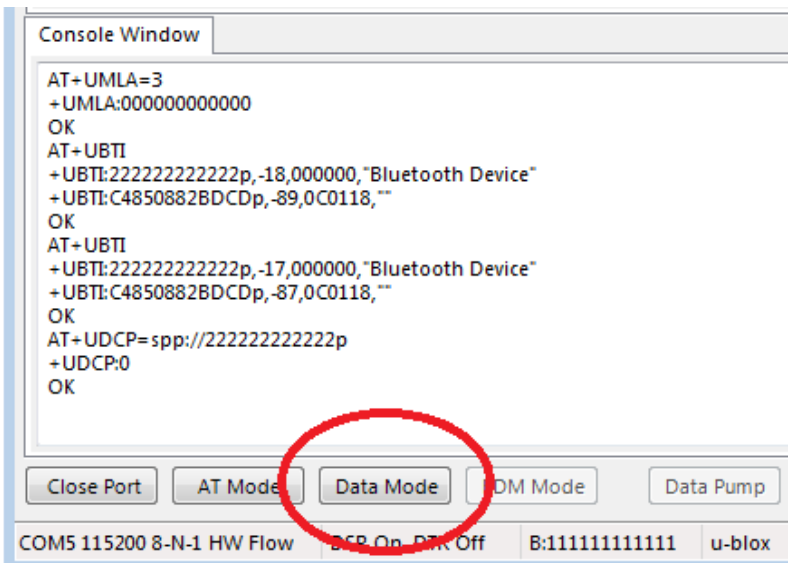

Figure 9: Switching to data mode in s-center

2.3.5 Basic Wi-Fi operation

Finding other units

Clicking the Wi-Fi Scan initiates a search for other Wi-Fi Access Points and the results are shown after about 5 seconds..

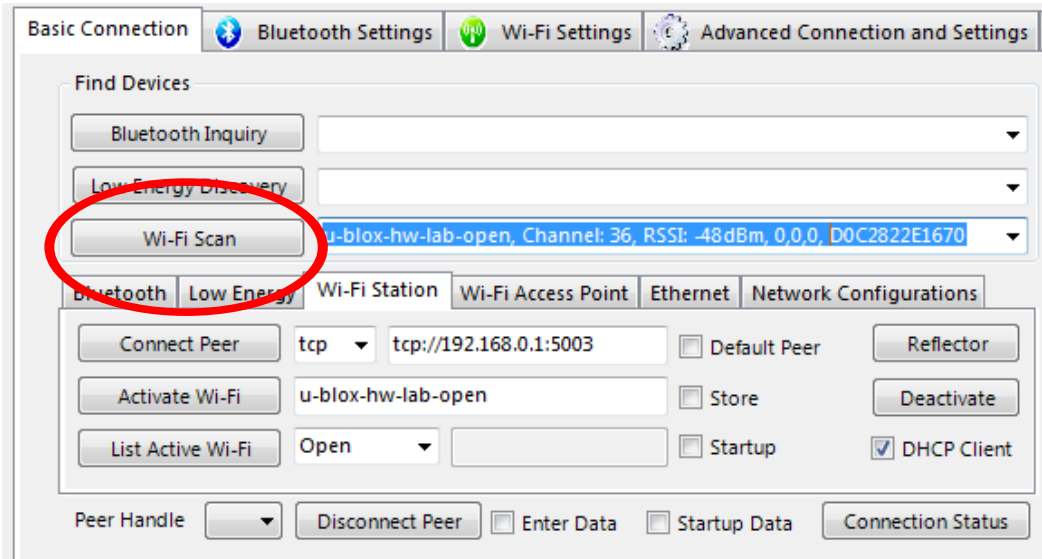

Figure 10: Scanning for Wi-Fi Networks in s-center

Connect to device

Select the Wi-Fi Access Point, enter the SSID, and if needed, enter the Password, and then press Activate Wi-Fi. Wait for the network interface to go up, and make sure an IP Address has been received. Then click Connect Peer to connect a TCP or UDP connection.

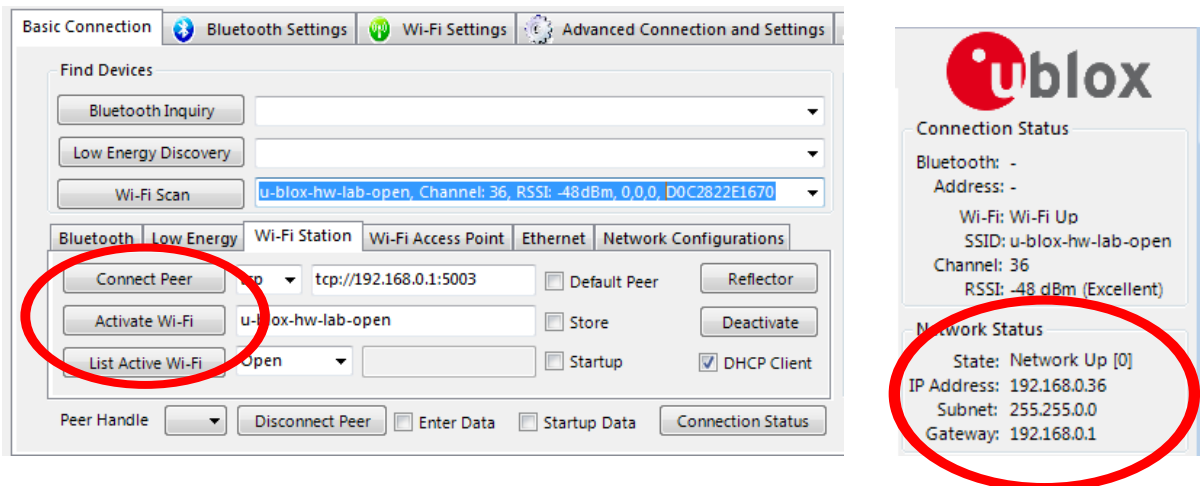

Figure 11: Activating Wi-Fi, TCP connection, and checking network status in s-center

2.4 Further information

See the *ODIN-W2 Getting started* [4] and *ODIN-W2 AT Commands manual* [1] for further settings.

2.5 Restoring default factory settings

While evaluating, if the current serial interface settings are lost or the interface becomes unresponsive, it might be necessary to perform a factory settings restore. Following the steps mentioned below will result in a complete restore of the settings of the serial interface and the current AT-configuration to factory defaults.

1. Press and hold the Restore button (SW2).
2. Press once on the Reset button (SW1).
3. The system mode LED will turn green. Continue holding the Restore button for around 5 seconds until the system mode LED turns orange.
4. Release the Restore button. The serial settings are now restored and the evaluation board is ready for use.

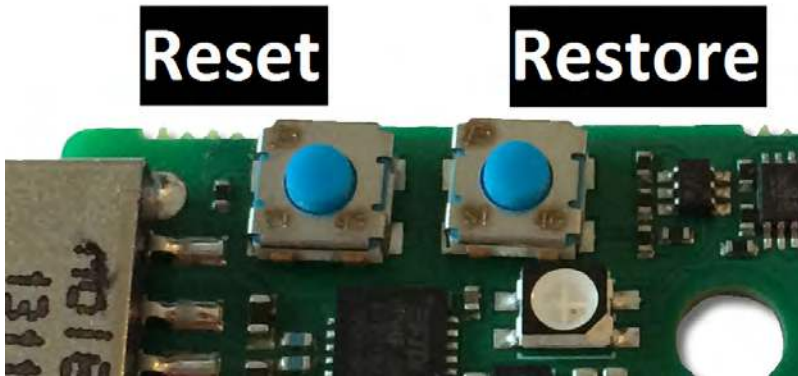

Figure 12: Position of the reset and restore buttons on the evaluation board

Appendix

A List of acronyms

Abbreviation / Term	Explanation / Definition
BT	Bluetooth
CAN	Controller Area Network
DHCP	Dynamic Host Configuration Protocol
FW	Firmware
GND	Ground
GPIO	General Purpose Input Output
H	High
I	Input (means that this is an input port of the module)
IEEE	Institute of Electrical and Electronics Engineers
L	Low
LPO	Low Power Oscillator
MIMO	Multi-Input Multi-Output
N/A	Not Applicable
O	Output (means that this is an output port of the module)
PCN / IN	Product Change Notification / Information Note
PD	Pull-Down
PU	Pull-Up
RXD	Receive Data
TCP	Transmission Control Protocol
TXD	Transmit Data
UART	Universal Asynchronous Receiver-Transmitter serial interface
UDP	User Datagram Protocol
USB	Universal Serial Bus

Table 7: Explanation of abbreviations used

Related documents

- [1] u-blox Short Range Modules AT Commands Manual, Document Number UBX-14044127
- [2] ODIN-W2 series Data Sheet, Document Number UBX-14039949
- [3] ODIN-W2 series System Integration Manual, Document Number UBX-14040040
- [4] ODIN-W2 Getting started, Document Number UBX-15017452

Revision history

Revision	Date	Name	Comments
R01	31-July-2015	ajoh	Initial release.
R02	21-Sep-2015	fbro	Update to Advance Information status.
R03	19-Mar-2016	cmag	Updated document status to Early Production Information. Added Basic Wi-Fi operation (section 2.3.5). Minor changes in section 1.1.
R04	26-May-2017	kgom	Minor updates.

Contact

For complete contact information visit us at www.u-blox.com.

u-blox Offices

North, Central and South America

u-blox America, Inc.

Phone: +1 703 483 3180
E-mail: info_us@u-blox.com

Regional Office West Coast:

Phone: +1 408 573 3640
E-mail: info_us@u-blox.com

Technical Support:

Phone: +1 703 483 3185
E-mail: support_us@u-blox.com

Headquarters Europe, Middle East, Africa

u-blox AG

Phone: +41 44 722 74 44
E-mail: info@u-blox.com
Support: support@u-blox.com

Asia, Australia, Pacific

u-blox Singapore Pte. Ltd.

Phone: +65 6734 3811
E-mail: info_ap@u-blox.com
Support: support_ap@u-blox.com

Regional Office Australia:

Phone: +61 2 8448 2016
E-mail: info_anz@u-blox.com
Support: support_ap@u-blox.com

Regional Office China (Beijing):

Phone: +86 10 68 133 545
E-mail: info_cn@u-blox.com
Support: support_cn@u-blox.com

Regional Office China (Chongqing):

Phone: +86 23 6815 1588
E-mail: info_cn@u-blox.com
Support: support_cn@u-blox.com

Regional Office China (Shanghai):

Phone: +86 21 6090 4832
E-mail: info_cn@u-blox.com
Support: support_cn@u-blox.com

Regional Office China (Shenzhen):

Phone: +86 755 8627 1083
E-mail: info_cn@u-blox.com
Support: support_cn@u-blox.com

Regional Office India:

Phone: +91 80 4050 9200
E-mail: info_in@u-blox.com
Support: support_in@u-blox.com

Regional Office Japan (Osaka):

Phone: +81 6 6941 3660
E-mail: info_jp@u-blox.com
Support: support_jp@u-blox.com

Regional Office Japan (Tokyo):

Phone: +81 3 5775 3850
E-mail: info_jp@u-blox.com
Support: support_jp@u-blox.com

Regional Office Korea:

Phone: +82 2 542 0861
E-mail: info_kr@u-blox.com
Support: support_kr@u-blox.com

Regional Office Taiwan:

Phone: +886 2 2657 1090
E-mail: info_tw@u-blox.com
Support: support_tw@u-blox.com