

Order Code	TCK-117
Inductance (each winding)	52 μ H \pm 25% (at 10 kHz / 50 mV)
Impedance (DCR)	15 m Ω max.
Rated Current	3.14 A max.
Rated Voltage	500 VDC max. (between windings)
Operating Temperature	-40°C to +105°C
RoHS Exemptions	No Exemptions

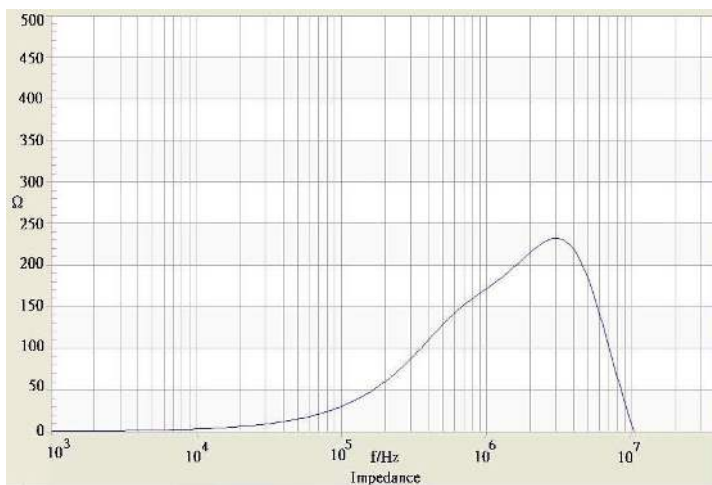

Impedance Curve



Outline Dimensions

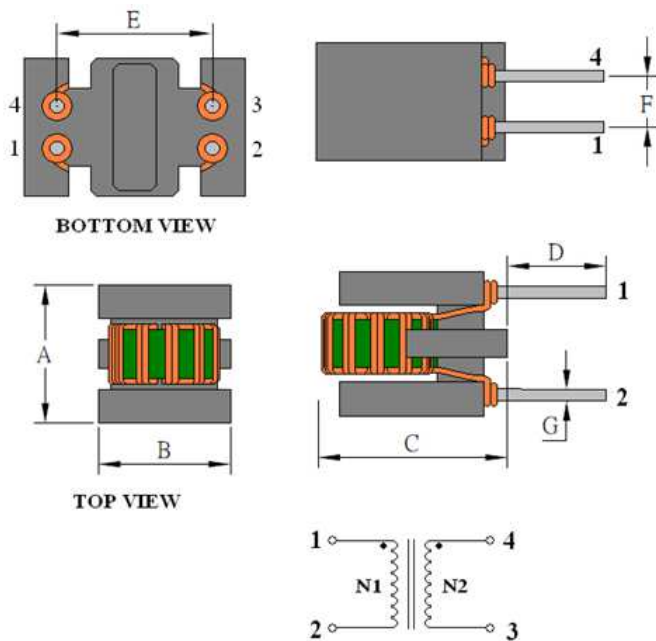

Dimensions [mm]	
A	7.5 max.
B	8.5 max.
C	10.5 max.
D	3.5 \pm 1.0
E	5.08 \pm 0.5
F	2.54 \pm 0.3
G	\varnothing 0.6 \pm 0.1

All specifications valid at +25°C, unless otherwise stated.