

**DDR4 DIMM
Memory Card
Extraction Tool**

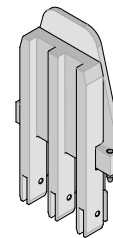

**Application Tooling
Specification Sheet**



Order No. 62100-1910

FEATURES

- Assists in ejecting the memory card from the 78839 series sockets
- Tool ejects four positions at the same time

SCOPE

Products: Four (4), DDR4 DIMM 0.85mm Pitch Sockets 288 circuits, mounted on 9.91mm (0.39in) centers.

Product List

The following is a partial list of the product order numbers and their specifications this tool is designed to be used on. Updates to this list are available on www.molex.com.

Series No.	Circuit Size	Assembly Order Number			
78839	288	78839-0100	78839-0200	78839-1101	78839-1102

DESCRIPTION

The 62100-1910 Memory Card Extraction Tool is a manual tool for ejecting DDR4 memory cards from four 78839 series card sockets.

This tool is intended for use only for sockets mounted on 9.91mm (0.39in) centers.

TOOL SETUP

This tool will extract four 288 circuit DDR4 memory cards without any adjustments. The tool cannot be adjusted for other size memory card sockets or sockets mounted on different spacing.

TOOL OPERATION

1. Locate the group of four memory cards to be removed.
2. Orient the tool before placing it on the sockets. Note that the tool frame has a lip on one side. This lip goes against the outside of the socket. The lip also prevents the tool from being placed backwards on the socket. See Figure 1.

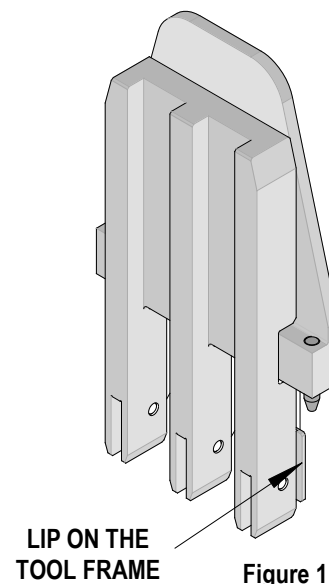

3. Approach the socket from the side with the extraction tool (the tool cannot be placed on the sockets directly from the top). See Figure 2.

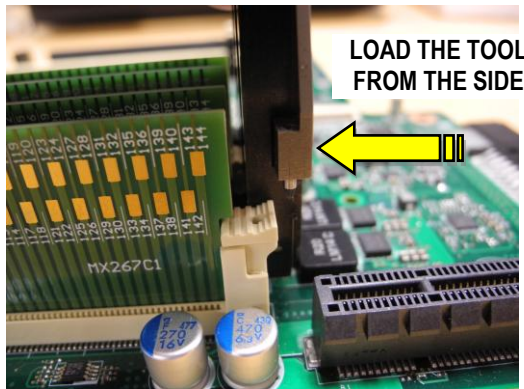

Figure 2

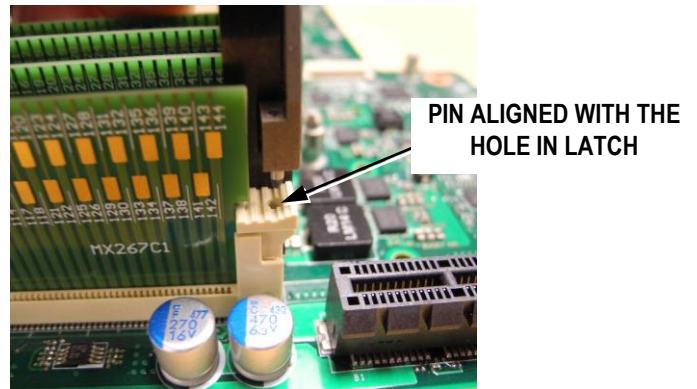

Figure 3

4. The lips on the tool frame will stop on the socket housing. At this point, the pins of the extraction tool should align to the holes in the socket latches. See Figure 3.
5. Gently push the extraction tool down until the tool rests on the socket latches. See Figure 4.

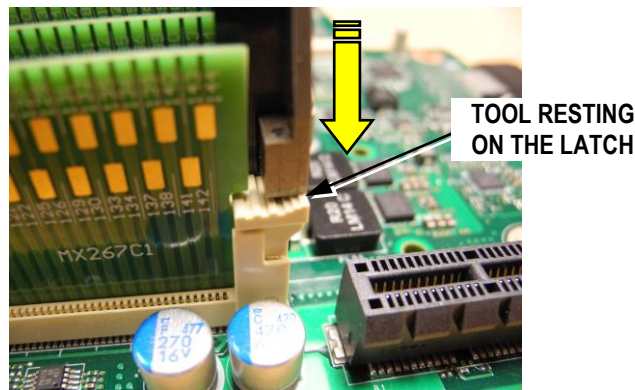

Figure 4

6. Grasp the extraction tool lever and pivot it away from the socket to extract one side of the memory modules. There is a built-in stop on the tool to prevent the latches from being swung too far open. See Figure 5.
7. Lift the extraction tool up until its pins are out of the socket latches. Then slide the tool out from the side. See Figure 6.

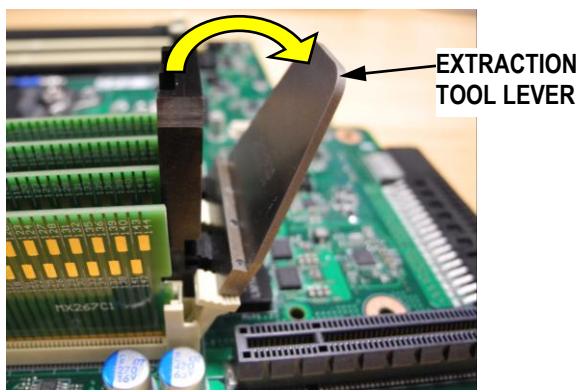

Figure 5

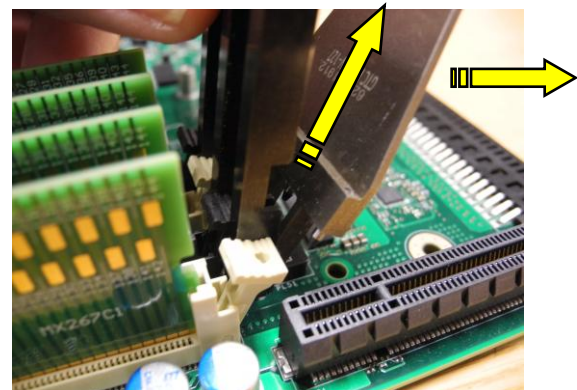

Figure 6

8. Repeat steps 3 – 7 for the other side of the memory module.

Maintenance

It is recommended that each operator of the tool be made aware of, and responsible for, the following maintenance steps:

1. Remove dust, moisture, and other contaminants with a clean brush, or soft, lint free cloth.
2. Do not use any abrasive materials that could damage the tool.
3. When tool is not in use, store in a clean, dry area.
4. There are no repair parts available for this tool. Should the tool be damaged a new tool is required.

CAUTION: Molex specifications are valid only when used with Molex connectors and tooling.

Contact Information

For more information on Molex application tooling please contact Molex at 1-800-786-6539.

Visit our Web site at <http://www.molex.com>