

## IGBT

High speed 5 IGBT in TRENCHSTOP™ 5 technology

## IGZ75N65H5

650V IGBT high speed series fifth generation

Data sheet

### High speed 5 IGBT in TRENCHSTOP™ 5 technology

#### Features and Benefits:

High speed H5 technology offering

- Ultra low loss switching thanks to Kelvin emitter pin in combination with TRENCHSTOP™ 5
- Best-in-class efficiency in hard switching and resonant topologies
- Plug and play replacement of previous generation IGBTs
- 650V breakdown voltage
- Low gate charge  $Q_G$
- Maximum junction temperature 175°C
- Qualified according to JEDEC for target applications
- Pb-free lead plating; RoHS compliant
- Complete product spectrum and PSpice Models:  
<http://www.infineon.com/igbt/>

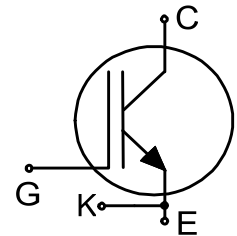

#### Applications

- Uninterruptible power supplies
- Welding converters
- Mid to high range switching frequency converters
- Solar string inverters

#### Package pin definition:

- Pin C & backside - collector
- Pin E - emitter
- Pin K - Kelvin emitter
- Pin G - gate

Please note: The emitter and Kelvin emitter pins are not exchangeable. Their exchange might lead to malfunction.



#### Key Performance and Package Parameters

| Type       | $V_{CE}$ | $I_C$ | $V_{CEsat}, T_{vj}=25^{\circ}C$ | $T_{vjmax}$ | Marking | Package    |
|------------|----------|-------|---------------------------------|-------------|---------|------------|
| IGZ75N65H5 | 650V     | 75A   | 1.65V                           | 175°C       | G75EH5  | PG-TO247-4 |

**Table of Contents**

|   |     |
|---|-----|
| Description .....                         | 2   |
| Table of Contents .....                   | 3   |
| Maximum Ratings .....                     | 4   |
| Thermal Resistance .....                  | 4   |
| Electrical Characteristics .....          | 4   |
| Electrical Characteristics Diagrams ..... | 6   |
| Package Drawing .....                     | .11 |
| Testing Conditions .....                  | .12 |
| Revision History .....                    | .13 |
| Disclaimer .....                          | .13 |

**Maximum Ratings**

For optimum lifetime and reliability, Infineon recommends operating conditions that do not exceed 80% of the maximum ratings stated in this datasheet.

| Parameter   | Symbol      | Value                | Unit               |
|---|-------------|----------------------|--------------------|
| Collector-emitter voltage, $T_{vj} \geq 25^{\circ}\text{C}$   | $V_{CE}$    | 650                  | V                  |
| DC collector current, limited by $T_{vjmax}$<br>$T_C = 25^{\circ}\text{C}$<br>$T_C = 100^{\circ}\text{C}$                 | $I_C$       | 119.0<br>75.0        | A                  |
| Pulsed collector current, $t_p$ limited by $T_{vjmax}^{1)}$   | $I_{Cpuls}$ | 300.0                | A                  |
| Turn off safe operating area<br>$V_{CE} \leq 650\text{V}$ , $T_{vj} \leq 175^{\circ}\text{C}$ , $t_p = 1\mu\text{s}^{1)}$ | -           | 300.0                | A                  |
| Gate-emitter voltage<br>Transient Gate-emitter voltage ( $t_p \leq 10\mu\text{s}$ , $D < 0.010$ )                         | $V_{GE}$    | $\pm 20$<br>$\pm 30$ | V                  |
| Power dissipation $T_C = 25^{\circ}\text{C}$<br>Power dissipation $T_C = 100^{\circ}\text{C}$                             | $P_{tot}$   | 395.0<br>197.0       | W                  |
| Operating junction temperature  | $T_{vj}$    | -40...+175           | $^{\circ}\text{C}$ |
| Storage temperature   | $T_{stg}$   | -55...+150           | $^{\circ}\text{C}$ |
| Soldering temperature,<br>wave soldering 1.6mm (0.063in.) from case for 10s   |             | 260                  | $^{\circ}\text{C}$ |
| Mounting torque, M3 screw<br>Maximum of mounting processes: 3   | $M$         | 0.6                  | Nm                 |

**Thermal Resistance**

| Parameter                                   | Symbol        | Conditions | Max. Value | Unit |
|---|---------------|------------|------------|------|
| <b>Characteristic</b>                       |               |            |            |      |
| IGBT thermal resistance,<br>junction - case | $R_{th(j-c)}$ |            | 0.38       | K/W  |
| Thermal resistance<br>junction - ambient    | $R_{th(j-a)}$ |            | 40         | K/W  |

**Electrical Characteristic, at  $T_{vj} = 25^{\circ}\text{C}$ , unless otherwise specified**

| Parameter                            | Symbol        | Conditions  | Value       |                      |                | Unit          |
|--------------------------------------|---------------|---|-------------|----------------------|----------------|---------------|
|                                      |               |   | min.        | typ.                 | max.           |               |
| <b>Static Characteristic</b>         |               |   |             |                      |                |               |
| Collector-emitter breakdown voltage  | $V_{(BR)CES}$ | $V_{GE} = 0\text{V}$ , $I_C = 0.20\text{mA}$  | 650         | -                    | -              | V             |
| Collector-emitter saturation voltage | $V_{CEsat}$   | $V_{GE} = 15.0\text{V}$ , $I_C = 75.0\text{A}$<br>$T_{vj} = 25^{\circ}\text{C}$<br>$T_{vj} = 100^{\circ}\text{C}$<br>$T_{vj} = 150^{\circ}\text{C}$ | -<br>-<br>- | 1.65<br>1.82<br>1.90 | 2.10<br>-<br>- | V             |
| Gate-emitter threshold voltage       | $V_{GE(th)}$  | $I_C = 0.75\text{mA}$ , $V_{CE} = V_{GE}$   | 3.2         | 4.0                  | 4.8            | V             |
| Zero gate voltage collector current  | $I_{CES}$     | $V_{CE} = 650\text{V}$ , $V_{GE} = 0\text{V}$<br>$T_{vj} = 25^{\circ}\text{C}$<br>$T_{vj} = 175^{\circ}\text{C}$                                    | -<br>-      | -<br>850.0           | 75.0<br>-      | $\mu\text{A}$ |
| Gate-emitter leakage current         | $I_{GES}$     | $V_{CE} = 0\text{V}$ , $V_{GE} = 20\text{V}$  | -           | -                    | 100            | nA            |
| Transconductance                     | $g_{fs}$      | $V_{CE} = 20\text{V}$ , $I_C = 75.0\text{A}$  | -           | 104.0                | -              | S             |

<sup>1)</sup> Defined by design. Not subject to production test.

**Electrical Characteristic, at  $T_{vj} = 25^{\circ}\text{C}$ , unless otherwise specified**

| Parameter   | Symbol    | Conditions  | Value |       |      | Unit |
|---|-----------|---|-------|-------|------|------|
|   |           |   | min.  | typ.  | max. |      |
| <b>Dynamic Characteristic</b>   |           |   |       |       |      |      |
| Input capacitance   | $C_{ies}$ | $V_{CE} = 25\text{V}, V_{GE} = 0\text{V}, f = 1\text{MHz}$      | -     | 4300  | -    | pF   |
| Output capacitance  | $C_{oes}$ |   | -     | 75    | -    |      |
| Reverse transfer capacitance  | $C_{res}$ |   | -     | 16    | -    |      |
| Gate charge   | $Q_G$     | $V_{CC} = 520\text{V}, I_C = 75.0\text{A}, V_{GE} = 15\text{V}$ | -     | 166.0 | -    | nC   |
| Internal emitter inductance <sup>1)</sup><br>measured 5mm (0.197 in.) from case | $L_E$     |   | -     | 13.0  | -    | nH   |

**Switching Characteristic, Inductive Load**

| Parameter | Symbol | Conditions | Value |      |      | Unit |
|-----------|--------|------------|-------|------|------|------|
|           |        |            | min.  | typ. | max. |      |

**IGBT Characteristic, at  $T_{vj} = 25^{\circ}\text{C}$** 

|                        |              |   |  |      |     |    |    |
|------------------------|--------------|---|--|------|-----|----|----|
| Turn-on delay time     | $t_{d(on)}$  | $T_{vj} = 25^{\circ}\text{C}, V_{CC} = 400\text{V}, I_C = 37.5\text{A}, V_{GE} = 0.0/15.0\text{V}, R_{G(on)} = 10.0\Omega, R_{G(off)} = 18.0\Omega, L_{\sigma} = 30\text{nH}, C_{\sigma} = 25\text{pF}$<br>$L_{\sigma}, C_{\sigma}$ from Fig. E | -  | 26   | -   | ns |    |
| Rise time              | $t_r$        |   | -  | 11   | -   | ns |    |
| Turn-off delay time    | $t_{d(off)}$ |   | Energy losses include "tail" and diode reverse recovery. Diode from IKZ75N65EH5. | -    | 347 | -  | ns |
| Fall time              | $t_f$        |   | -  | 15   | -   | ns |    |
| Turn-on energy         | $E_{on}$     |   | -  | 0.68 | -   | mJ |    |
| Turn-off energy        | $E_{off}$    |   | -  | 0.43 | -   | mJ |    |
| Total switching energy | $E_{ts}$     |   | -  | 1.11 | -   | mJ |    |

**Switching Characteristic, Inductive Load**

| Parameter | Symbol | Conditions | Value |      |      | Unit |
|-----------|--------|------------|-------|------|------|------|
|           |        |            | min.  | typ. | max. |      |

**IGBT Characteristic, at  $T_{vj} = 150^{\circ}\text{C}$** 

|                        |              |  |  |      |     |    |    |
|------------------------|--------------|--|--|------|-----|----|----|
| Turn-on delay time     | $t_{d(on)}$  | $T_{vj} = 150^{\circ}\text{C}, V_{CC} = 400\text{V}, I_C = 37.5\text{A}, V_{GE} = 0.0/15.0\text{V}, R_{G(on)} = 10.0\Omega, R_{G(off)} = 18.0\Omega, L_{\sigma} = 30\text{nH}, C_{\sigma} = 25\text{pF}$<br>$L_{\sigma}, C_{\sigma}$ from Fig. E | -  | 24   | -   | ns |    |
| Rise time              | $t_r$        |  | -  | 13   | -   | ns |    |
| Turn-off delay time    | $t_{d(off)}$ |  | Energy losses include "tail" and diode reverse recovery. Diode from IKZ75N65EH5. | -    | 400 | -  | ns |
| Fall time              | $t_f$        |  | -  | 15   | -   | ns |    |
| Turn-on energy         | $E_{on}$     |  | -  | 1.10 | -   | mJ |    |
| Turn-off energy        | $E_{off}$    |  | -  | 0.48 | -   | mJ |    |
| Total switching energy | $E_{ts}$     |  | -  | 1.58 | -   | mJ |    |

<sup>1)</sup> The internal emitter inductance does not affect the gate control circuitry if bypassed by using the emitter sense pin.

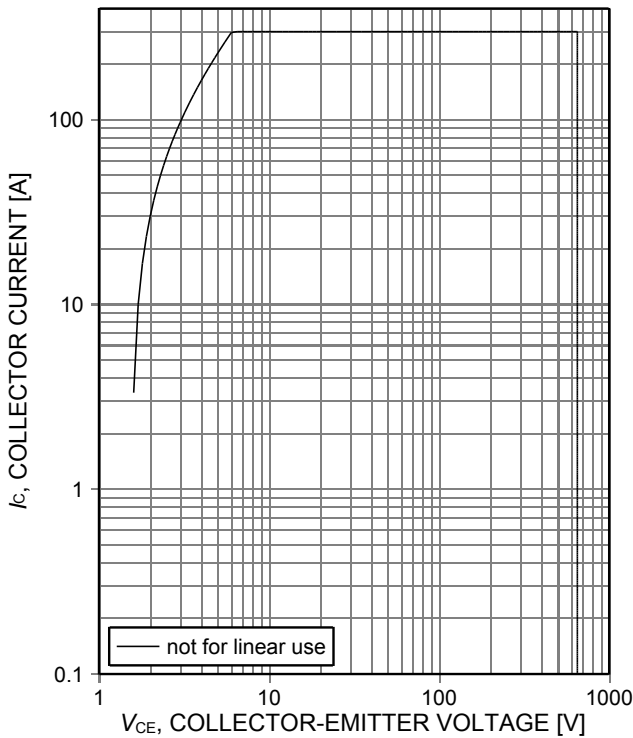

Figure 1. **Forward bias safe operating area**  
 ( $D=0$ ,  $T_C=25^\circ\text{C}$ ,  $T_{vj}\leq 175^\circ\text{C}$ ,  $V_{GE}=15\text{V}$ ,  $t_p=1\mu\text{s}$ ,  
 $I_{Cmax}$  defined by design - not subject to production test)

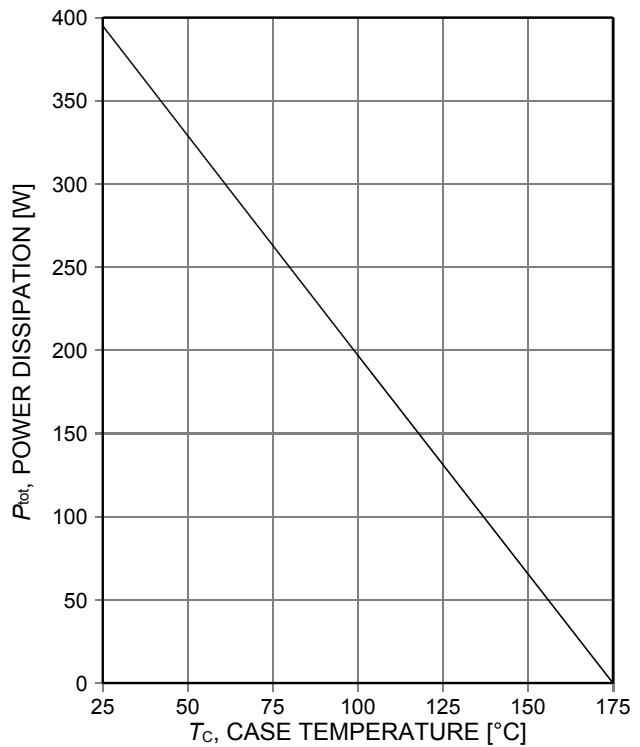

Figure 2. **Power dissipation as a function of case temperature**  
 ( $T_{vj}\leq 175^\circ\text{C}$ )

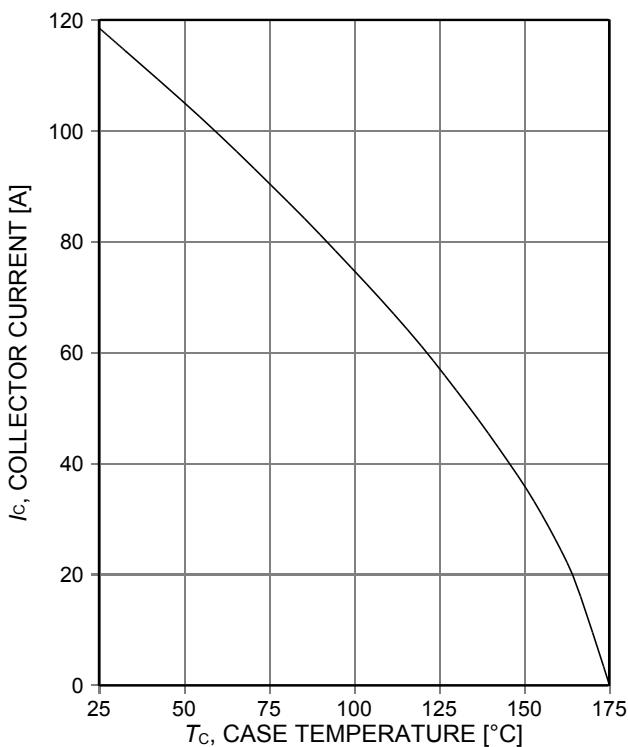

Figure 3. **Collector current as a function of case temperature**  
 ( $V_{GE}\geq 15\text{V}$ ,  $T_{vj}\leq 175^\circ\text{C}$ )

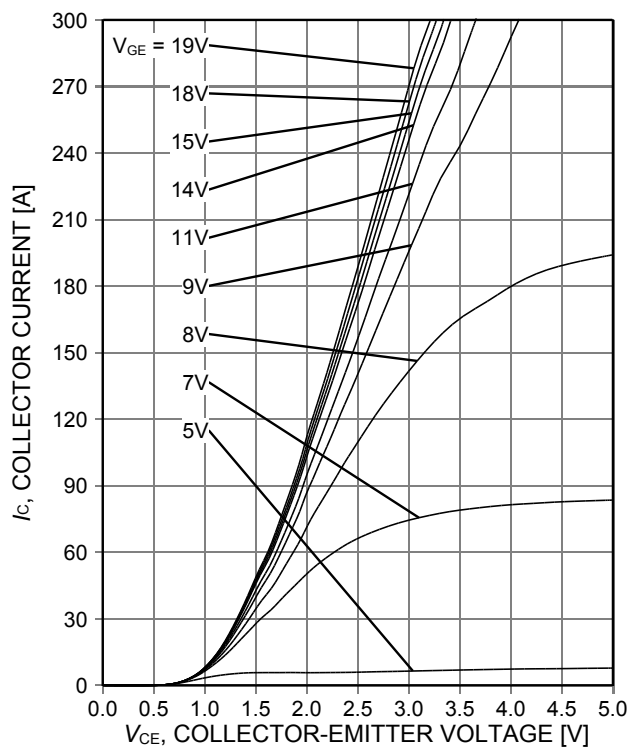

Figure 4. **Typical output characteristic**  
 ( $T_{vj}=25^\circ\text{C}$ )

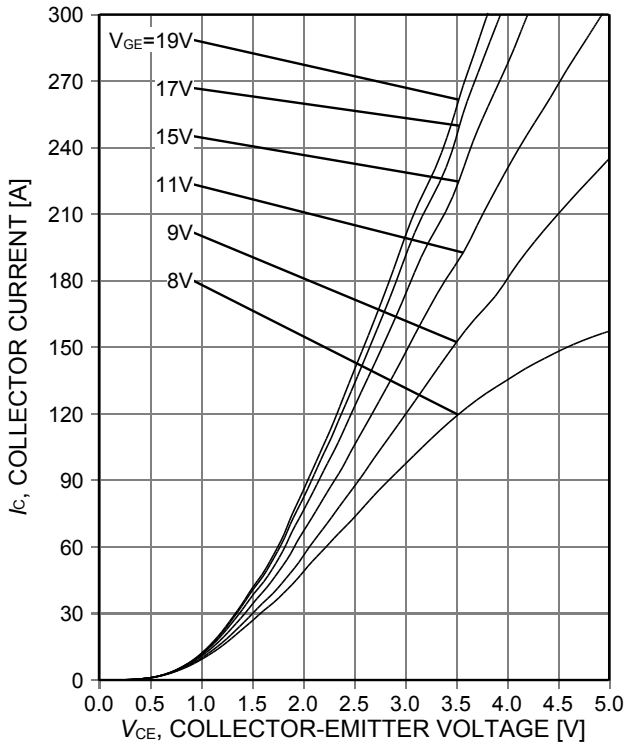

Figure 5. **Typical output characteristic**  
( $T_{vj}=175^{\circ}\text{C}$ )

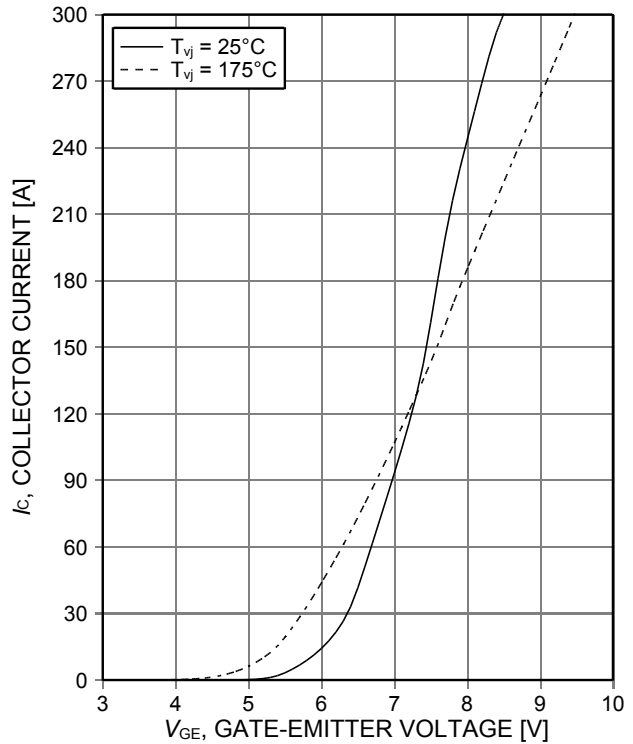

Figure 6. **Typical transfer characteristic**  
( $V_{CE}=20\text{V}$ )

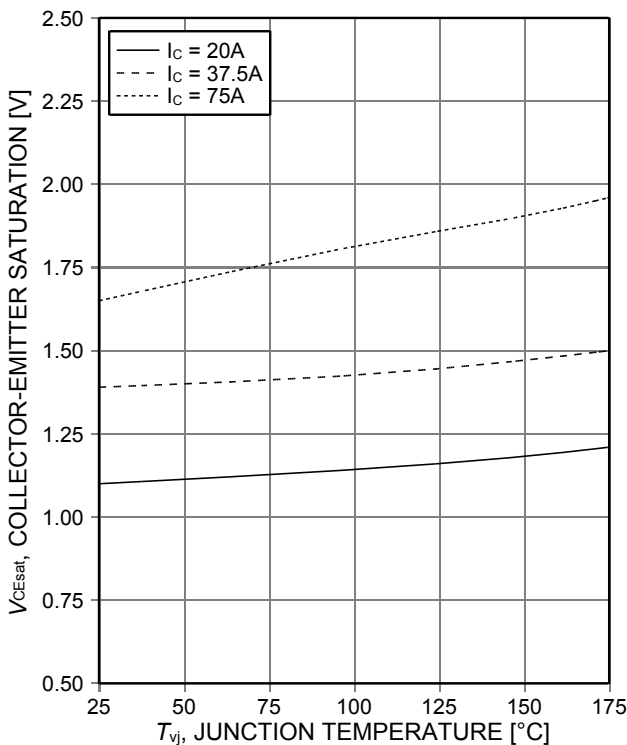

Figure 7. **Typical collector-emitter saturation voltage as a function of junction temperature**  
( $V_{GE}=15\text{V}$ )

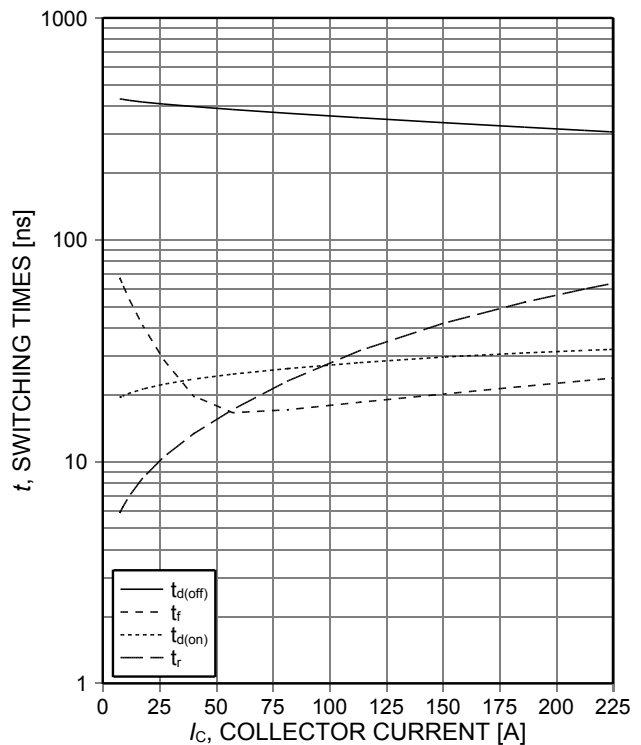

Figure 8. **Typical switching times as a function of collector current**  
(inductive load,  $T_{vj}=150^{\circ}\text{C}$ ,  $V_{CE}=400\text{V}$ ,  $V_{GE}=0/15\text{V}$ ,  $R_{G(on)}=10\Omega$ ,  $R_{G(off)}=18\Omega$ , dynamic test circuit in Figure E)

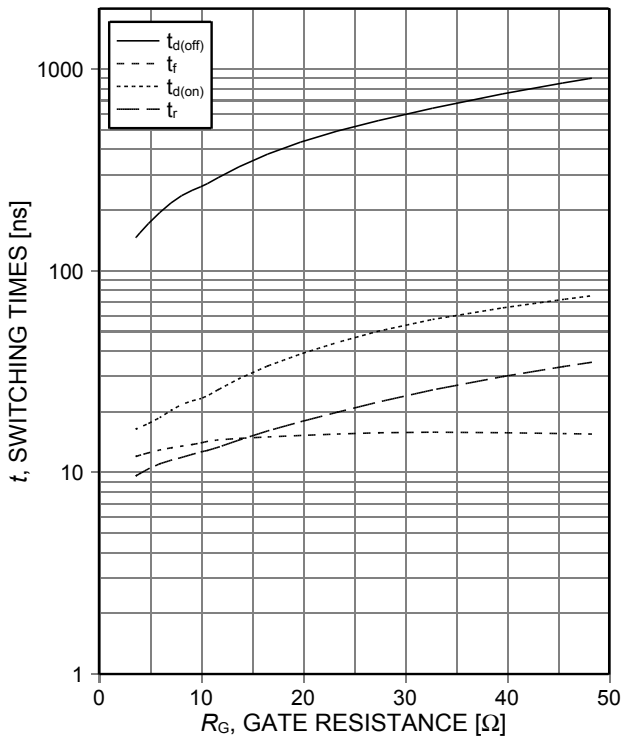

Figure 9. **Typical switching times as a function of gate resistance**  
 (inductive load,  $T_{vj}=150^{\circ}\text{C}$ ,  $V_{CE}=400\text{V}$ ,  $V_{GE}=0/15\text{V}$ ,  $I_C=37.5\text{A}$ , dynamic test circuit in Figure E)

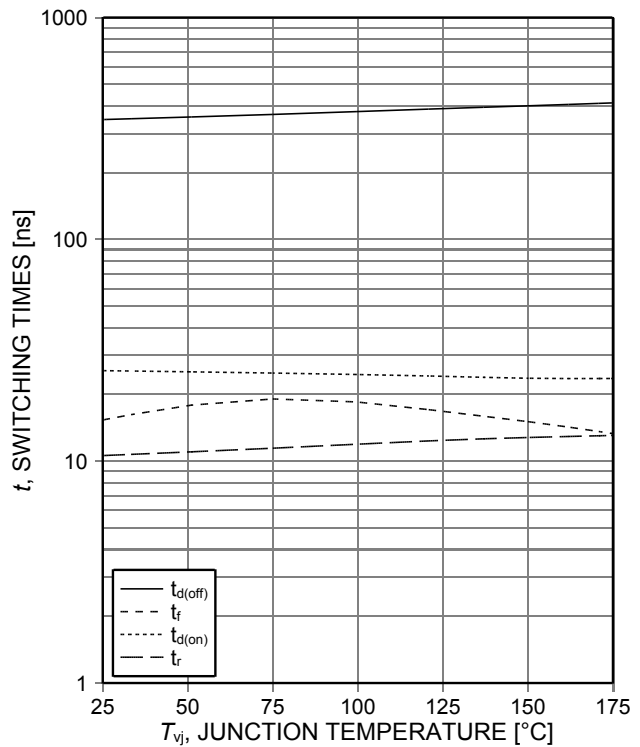

Figure 10. **Typical switching times as a function of junction temperature**  
 (inductive load,  $V_{CE}=400\text{V}$ ,  $V_{GE}=0/15\text{V}$ ,  $I_C=37.5\text{A}$ ,  $R_{G(on)}=10\Omega$ ,  $R_{G(off)}=18\Omega$ , dynamic test circuit in Figure E)

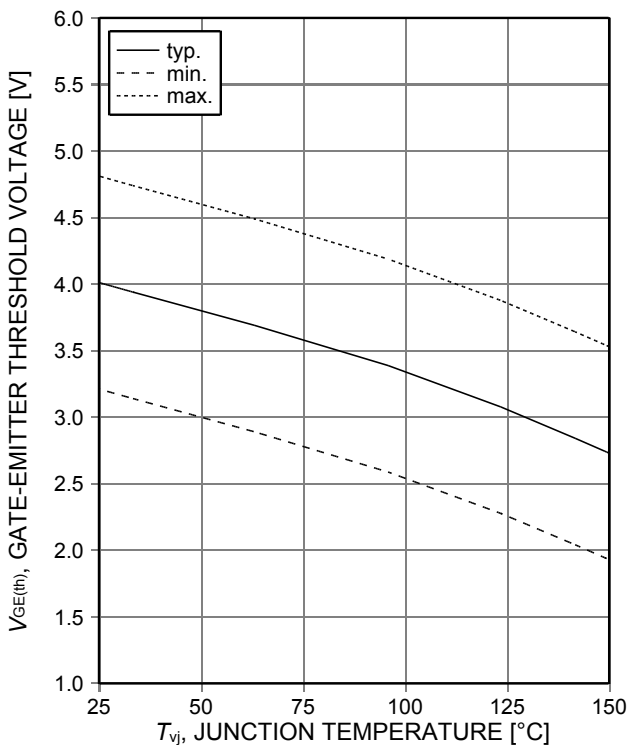

Figure 11. **Gate-emitter threshold voltage as a function of junction temperature**  
 ( $I_C=0.75\text{mA}$ )

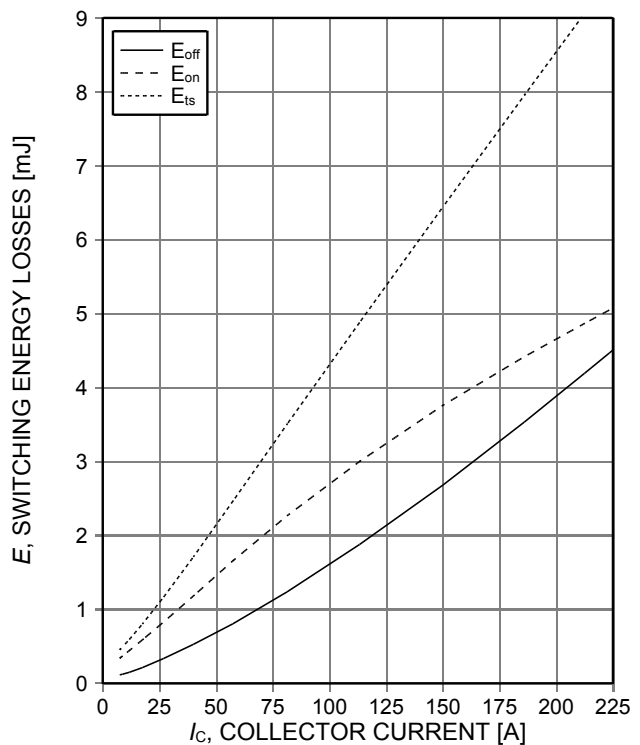

Figure 12. **Typical switching energy losses as a function of collector current**  
 (inductive load,  $T_{vj}=150^{\circ}\text{C}$ ,  $V_{CE}=400\text{V}$ ,  $V_{GE}=0/15\text{V}$ ,  $R_{G(on)}=10\Omega$ ,  $R_{G(off)}=18\Omega$ , dynamic test circuit in Figure E)



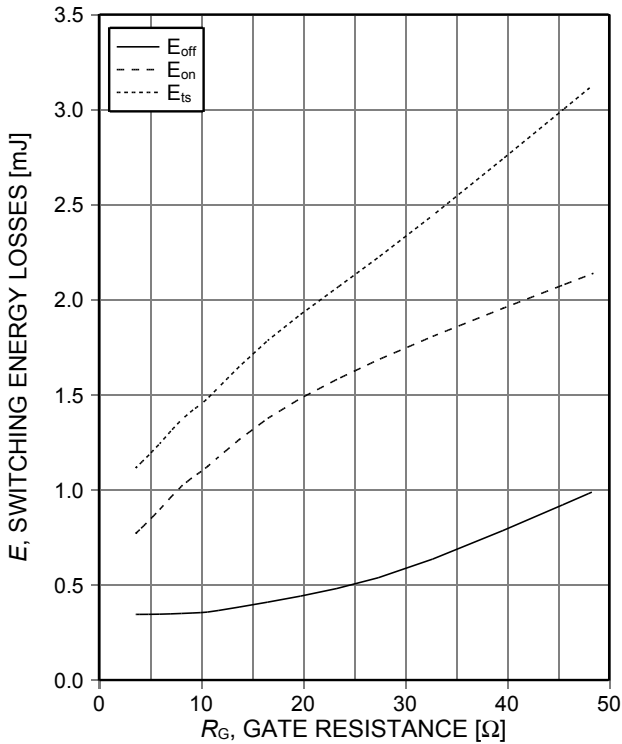

Figure 13. **Typical switching energy losses as a function of gate resistance**  
 (inductive load,  $T_{vj}=150^{\circ}\text{C}$ ,  $V_{CE}=400\text{V}$ ,  $V_{GE}=0/15\text{V}$ ,  $I_C=37.5\text{A}$ , dynamic test circuit in Figure E)

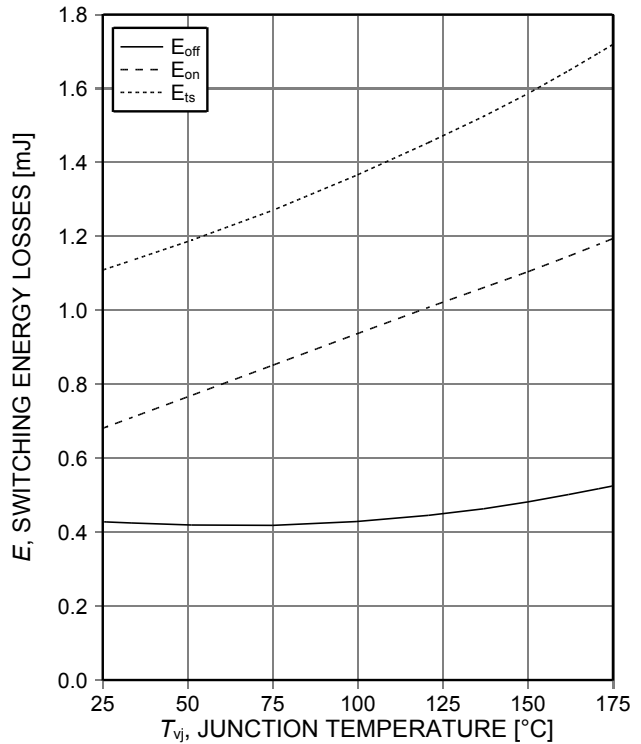

Figure 14. **Typical switching energy losses as a function of junction temperature**  
 (inductive load,  $V_{CE}=400\text{V}$ ,  $V_{GE}=0/15\text{V}$ ,  $I_C=37.5\text{A}$ ,  $R_{G(on)}=10\Omega$ ,  $R_{G(off)}=18\Omega$ , dynamic test circuit in Figure E)

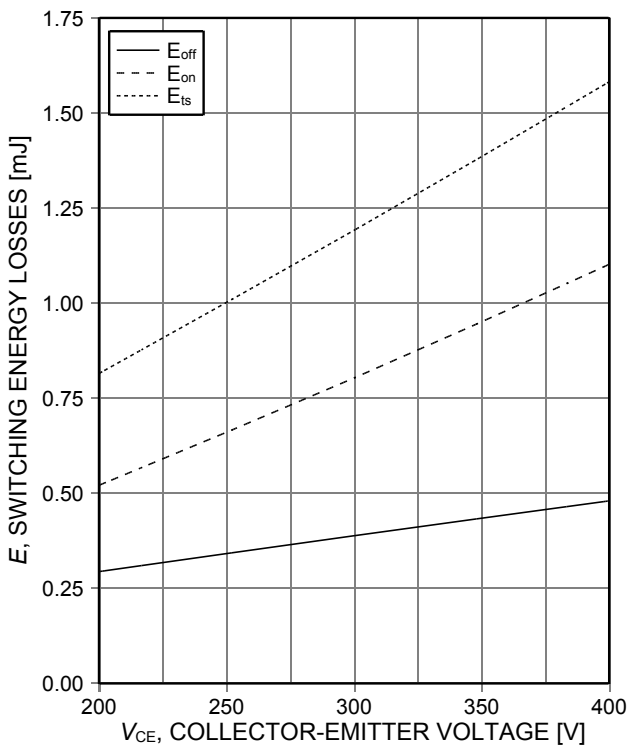

Figure 15. **Typical switching energy losses as a function of collector emitter voltage**  
 (inductive load,  $T_{vj}=150^{\circ}\text{C}$ ,  $V_{GE}=0/15\text{V}$ ,  $I_C=37.5\text{A}$ ,  $R_{G(on)}=10\Omega$ ,  $R_{G(off)}=18\Omega$ , dynamic test circuit in Figure E)

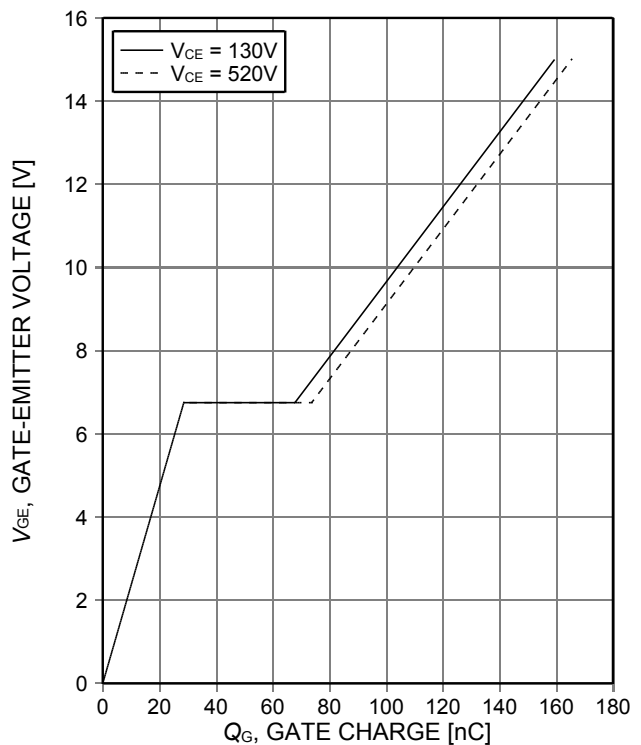

Figure 16. **Typical gate charge**  
 ( $I_C=75\text{A}$ )

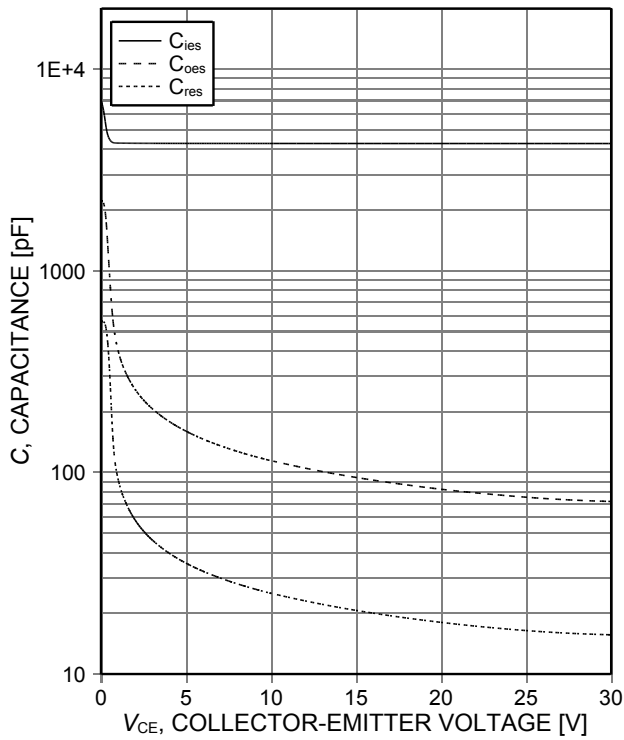

Figure 17. Typical capacitance as a function of collector-emitter voltage ( $V_{GE}=0V$ ,  $f=1MHz$ )

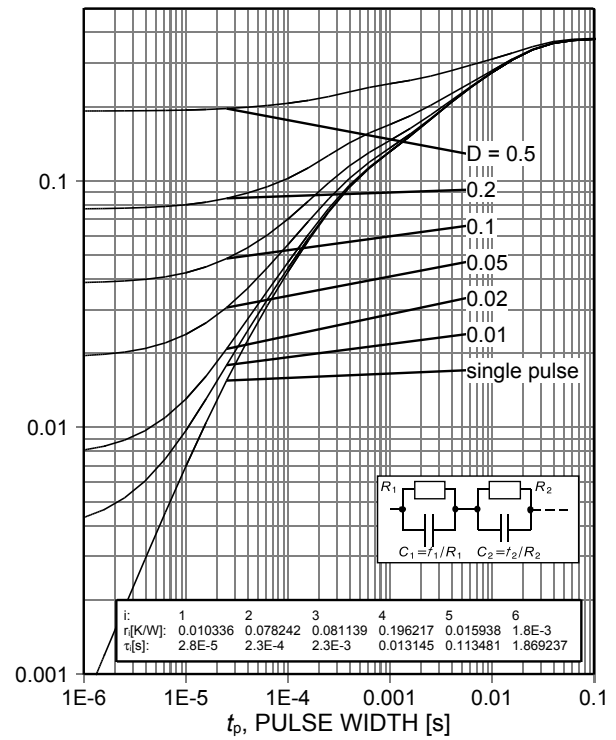
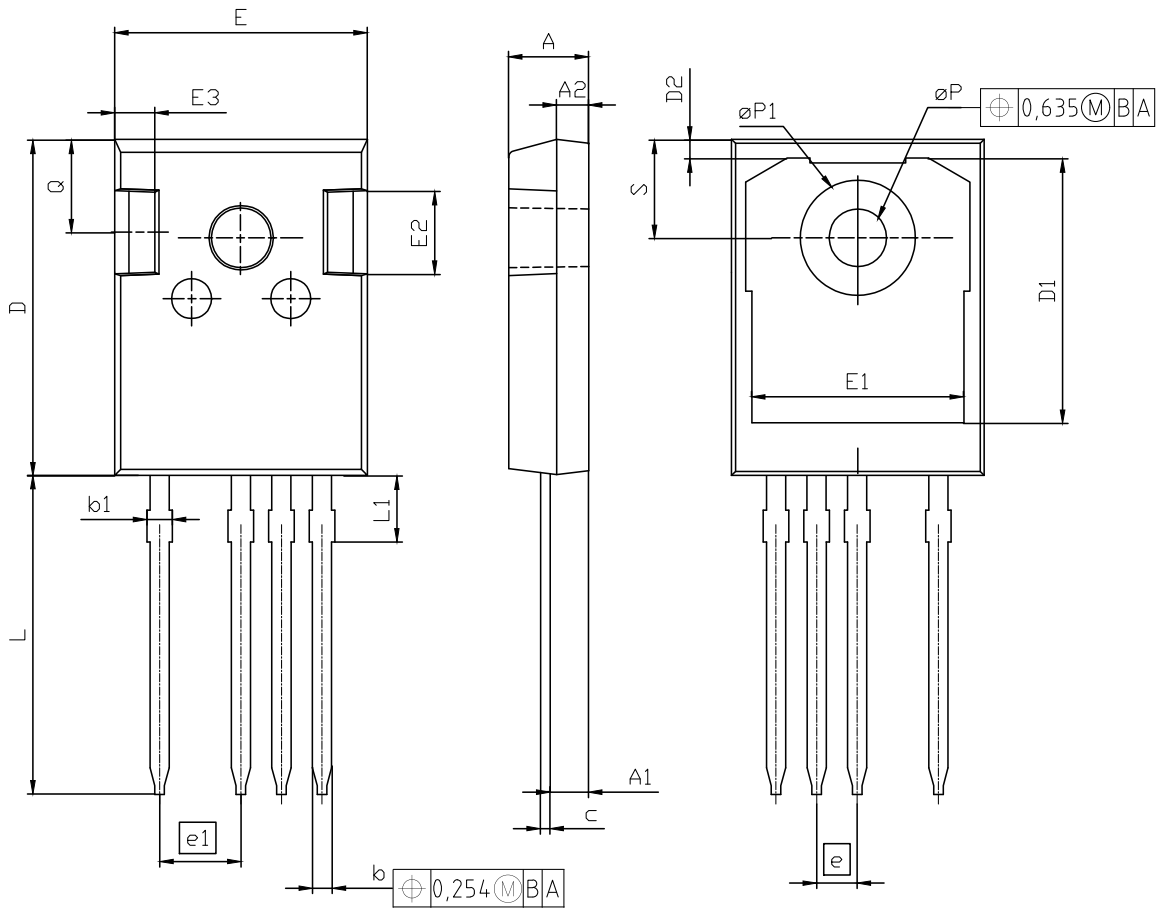

Figure 18. IGBT transient thermal impedance ( $D=t_p/T$ )

PG-TO247-4



| DIM | MILLIMETERS |       | INCHES      |       |
|-----|-------------|-------|-------------|-------|
|     | MIN         | MAX   | MIN         | MAX   |
| A   | 4.83        | 5.21  | 0.190       | 0.205 |
| A1  | 2.29        | 2.54  | 0.090       | 0.100 |
| A2  | 1.90        | 2.16  | 0.075       | 0.085 |
| b   | 1.07        | 1.33  | 0.042       | 0.052 |
| b1  | 1.10        | 1.70  | 0.043       | 0.067 |
| c   | 0.50        | 0.70  | 0.020       | 0.028 |
| D   | 20.80       | 21.10 | 0.819       | 0.831 |
| D1  | 16.25       | 17.65 | 0.640       | 0.695 |
| D2  | 0.95        | 1.35  | 0.037       | 0.053 |
| E   | 15.70       | 16.13 | 0.618       | 0.635 |
| E1  | 13.10       | 14.15 | 0.516       | 0.557 |
| E2  | 3.68        | 5.10  | 0.145       | 0.201 |
| E3  | 1.00        | 2.60  | 0.039       | 0.102 |
| e   | 2.54 (BSC)  |       | 0.100 (BSC) |       |
| e1  | 5.08        |       | 0.200       |       |
| N   | 4           |       | 4           |       |
| L   | 19.72       | 20.32 | 0.776       | 0.800 |
| L1  | 4.02        | 4.40  | 0.158       | 0.173 |
| øP  | 3.50        | 3.70  | 0.138       | 0.146 |
| øP1 | 7.00        | 7.40  | 0.276       | 0.291 |
| Q   | 5.49        | 6.00  | 0.216       | 0.236 |
| S   | 6.04        | 6.30  | 0.238       | 0.248 |

**DOCUMENT NO.**  
Z8B00168124

**SCALE**

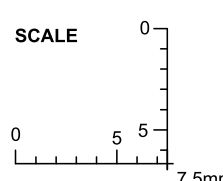

**EUROPEAN PROJECTION**

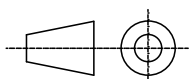

**ISSUE DATE**  
29-01-2013

**REVISION**  
1

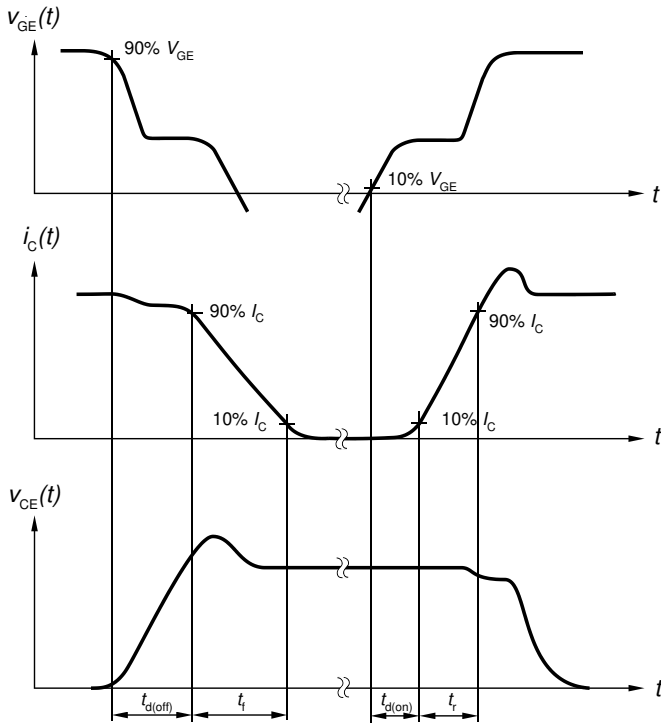

Figure A. Definition of switching times

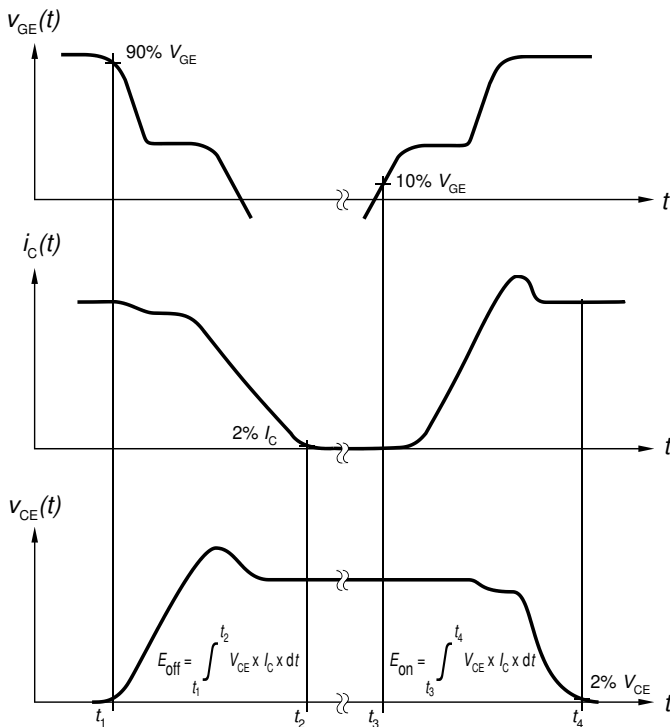

Figure B. Definition of switching losses

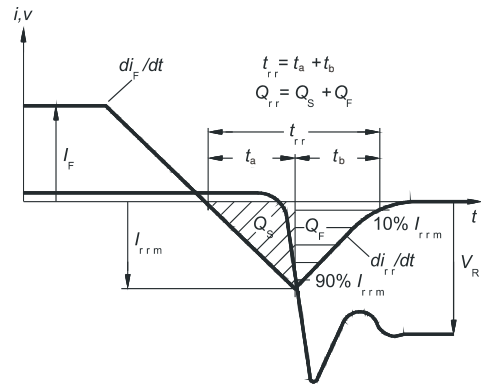

Figure C. Definition of diodes switching characteristics

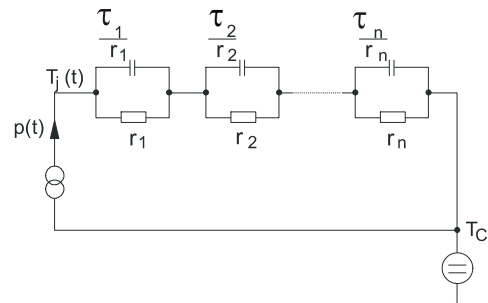

Figure D. Thermal equivalent circuit

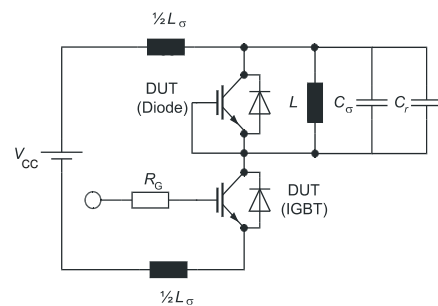

Figure E. Dynamic test circuit  
Parasitic inductance  $L_\sigma$ ,  
parasitic capacitor  $C_\sigma$ ,  
relief capacitor  $C_r$   
(only for ZVT switching)

## Revision History

IGZ75N65H5

Revision: 2014-10-31, Rev. 2.1

## Previous Revision

| Revision | Date       | Subjects (major changes since last revision) |
|----------|------------|--|
| 1.1      | 2014-10-17 | Preliminary data sheet                       |
| 2.1      | 2014-10-31 | Final data sheet                             |

## We Listen to Your Comments

Any information within this document that you feel is wrong, unclear or missing at all ?

Your feedback will help us to continuously improve the quality of this document.

Please send your proposal (including a reference to this document) to: [erratum@infineon.com](mailto:erratum@infineon.com)

## Published by

Infineon Technologies AG

81726 Munich, Germany

81726 München, Germany

© 2014 Infineon Technologies AG

All Rights Reserved.

## Legal Disclaimer

The information given in this document shall in no event be regarded as a guarantee of conditions or characteristics.

With respect to any examples or hints given herein, any typical values stated herein and/or any information regarding the application of the device, Infineon Technologies hereby disclaims any and all warranties and liabilities of any kind, including without limitation, warranties of non-infringement of intellectual property rights of any third party.

## Information

For further information on technology, delivery terms and conditions and prices, please contact the nearest Infineon Technologies Office ([www.infineon.com](http://www.infineon.com)).

## Warnings

Due to technical requirements, components may contain dangerous substances. For information on the types in question, please contact the nearest Infineon Technologies Office.

The Infineon Technologies component described in this Data Sheet may be used in life-support devices or systems and/or automotive, aviation and aerospace applications or systems only with the express written approval of Infineon Technologies, if a failure of such components can reasonably be expected to cause the failure of that life-support, automotive, aviation and aerospace device or system or to affect the safety or effectiveness of that device or system. Life support devices or systems are intended to be implanted in the human body or to support and/or maintain and sustain and/or protect human life. If they fail, it is reasonable to assume that the health of the user or other persons may be endangered.