

# NCT51, NCT52

## Ultra Small Temperature Switch with Pin-Selectable Hysteresis

The NCT51 and NCT52 are SOT-23 temperature switches that require no external components and the design is facilitated with factory-programmed temperature thresholds. A choice of factory-trimmed temperature trip points are available. Pin selectable hysteresis of +2°C or +10°C allows flexibility to the design. These parts typically consume only 17 µA of current and operate over the entire -55°C to +125°C temperature range while offering accuracies of ±0.5°C (typ) and ±4°C (max).

The NCT51 has an open drain, active low output, meant for microprocessor reset control. The NCT52 has a CMOS, active high output designed to drive a logic level MOSFET to turn on a fan or heater element.

The NCT51/NCT52 are aimed for hot-temperature monitoring (+45°C to +115°C). These devices assert a logic signal when the temperature goes above the threshold.

The NCT51 and NCT52 are offered in three standard temperature thresholds. Available in 5-Pin SOT-23A packages, these parts are ideal for applications requiring high integration, small size, low power and low installed cost.

### Features

- 5-Pin SOT-23A
- Factory-Programmed Thresholds from +45°C to +115°C in 10°C Increments
- Pin-Selectable +2°C or +10°C Hysteresis
- ±0.5°C (Typ) Threshold Accuracy Over Full Temperature Range
- No External Components Required
- 17 µA Supply Current

### Typical Applications

- Thermal Management in PCs and Servers
- Over Temperature Fail Safe Circuits
- Simple Fan Controller
- Temperature Alarms
- Projectors/Printers
- Notebook Computers
- Network Boxes



ON Semiconductor®

<http://onsemi.com>

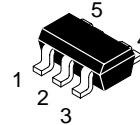

SOT-23A  
SN SUFFIX  
CASE 1212

### PIN CONNECTIONS

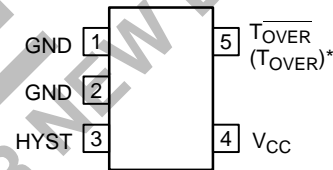

\*For NCT52

Note: 5-Pin SOT-23A is equivalent to EIAJ SC-74A

### ORDERING INFORMATION

See detailed ordering and shipping information in the package dimensions section on page 9 of this data sheet.

### DEVICE MARKING INFORMATION

See general marking information in the device marking section on page 9 of this data sheet.

# NCT51, NCT52

## MAXIMUM RATINGS\*

Rating	Symbol	Value	Unit
Supply Voltage	$V_{CC}$	-0.3 to +7.0	V
$T_{OVER}$ (NCT51)	-	-0.3 to +7.0	V
$T_{OVER}$ (NCT52)	-	-0.3 to ( $V_{CC} + 0.3$ )	V
All Other Pins	-	-0.3 to ( $V_{CC} + 0.3$ )	V
Input Current (All Pins)	-	20	mA
Output Current (All Pins)	-	20	mA
Operating Temperature Range	-	-55 to +125	°C
Storage Temperature Range	$T_{stg}$	-65 to +165	°C
Lead Temperature (Soldering, 10 seconds)	-	+300	°C
Power Dissipation ( $T_A = +70^{\circ}\text{C}$ ) (Derate 7.1 mW/°C Above +70°C)	-	571	mW

\*Static-sensitive device. Unused devices must be stored in conductive material. Protect devices from static discharge and static fields. Stresses above those listed under Absolute Maximum Ratings may cause permanent damage to the device. These are stress ratings only and functional operation of the device at these or any other conditions above those indicated in the operational sections of the specifications is not implied. Exposure to Absolute Maximum Rating Conditions for extended periods may affect device reliability.

**ELECTRICAL CHARACTERISTICS**  $V_{CC} = +2.7\text{ V to }+5.5\text{ V}$ ,  $R_{PULL-UP} = 100\text{ k}\Omega$  (NCT51 only),  $C_{COUPLING} = 100\text{ pF}$  from  $V_{CC}$  to GND,  $T_A = T_{MIN}$  to  $T_{MAX}$ , unless otherwise noted. Typical values are at  $T_A = +25^{\circ}\text{C}$ .

Characteristics	Test Conditions	Symbol	Min	Typ	Max	Unit
Supply Voltage Range	-	$V_{CC}$	2.7	-	5.5	V
Supply Current	-	$I_{CC}$	-	17	40	$\mu\text{A}$
Temperature Threshold Accuracy (Note 1)	+45°C to +65°C +75°C to +115°C	$\Delta T_{TH}$	-4.0 -6.0	$\pm 0.5$ $\pm 0.5$	4.0 6.0	°C
Temperature Threshold Hysteresis	HYST = GND HYST = $V_{CC}$	$T_{HYST}$	- -	2.0 10	- -	°C
HYST Input Threshold	-	$V_{IH}$	$0.8 \times V_{CC}$	-	-	V
HYST Input Threshold	-	$V_{IL}$	-	-	$0.2 \times V_{CC}$	V
Output Voltage High	$I_{SOURCE} = 500\text{ }\mu\text{A}$ , $V_{CC} > 2.7\text{ V}$ (NCT52 Only) $I_{SOURCE} = 800\text{ }\mu\text{A}$ , $V_{CC} > 4.5\text{ V}$ (NCT52 Only)	$V_{OH}$	$0.8 \times V_{CC}$ $V_{CC} - 1.5$	- -	- -	V
Output Voltage Low	$I_{SINK} = 1.2\text{ mA}$ , $V_{CC} > 2.7\text{ V}$ $I_{SINK} = 3.2\text{ mA}$ , $V_{CC} > 4.5\text{ V}$	$V_{OL}$	- -	- -	0.3 0.4	V
Open-Drain Output Leakage Current	$V_{CC} = 2.7\text{ V}$ , $V_{TOVER} = 5.5\text{ V}$ (NCT51 Only)	-	-	10	-	nA

1. The NCT51 and NCT52 are available with internal, factory-programmed temperature trip thresholds from +45°C to +115°C in +10°C increments.

# NCT51, NCT52

## PIN DESCRIPTION

NCT51	NCT52	Name	Description
1,2	1,2	GND	Ground. Ground both pins together close to the chip. Pin 2 provides the lowest thermal resistance to the die.
3	3	HYST	Hysteresis Input. Connect HYST to GND for +2°C hysteresis, or connect to V <sub>CC</sub> for +10°C hysteresis.
4	4	V <sub>CC</sub>	Supply Input (+2.7 V to +5.5 V). Recommend 100 pF or greater Coupling capacitor from V <sub>CC</sub> to GND.
5	–	TOVER	Open–Drain, Active–Low Output. $\overline{\text{TOVER}}$ goes low when the die temperature exceeds the factory–programmed temperature threshold. Connect to a 100 K $\Omega$ pull–up resistor. May be pulled up to a voltage higher than V <sub>CC</sub> .
–	5	TOVER	Push/Pull Active–High Output. TOVER goes high when the die temperature exceeds the factory–programmed temperature threshold.
–	–	$\overline{\text{TUNDER}}$	Open–Drain, Active–Low Output. $\overline{\text{TUNDER}}$ goes low when the die temperature goes below the factory–programmed temperature threshold. Connect to a 100 K $\Omega$ pull–up resistor. May be pulled up to a voltage higher than V <sub>CC</sub> .
–	–	TUNDER	Push/Pull Active–High Output. TUNDER goes high when the die temperature is below the factory–programmed temperature threshold.

### Typical Operating Circuit

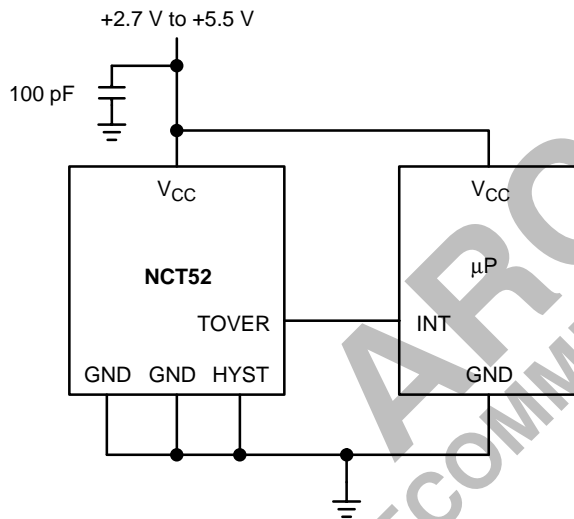

### DETAILED DESCRIPTION

The NCT51 and NCT52 integrate a temperature sensor with a factory–programmed threshold switch. A logic signal is asserted when the die temperature crosses the factory programmed threshold. An external hysteresis input pin allows the user to select either 2°C or 10°C hysteresis to give further flexibility to the design of the application. The NCT51 and NCT52 are intended for a temperature range from 45°C to 115°C in a 10°C increment. The NCT51 has an open drain output and the NCT52 has a push/pull output stage.

The NCT51 is intended for applications with a microprocessor reset input. The NCT52 is intended for applications of turning on a fan or heater element.

### Hysteresis Input

To prevent the output from “chattering” at or near the trip point temperature, a selectable HYST input pin is provided. Hysteresis can be externally selected at 2°C (HYST = GND) or 10°C (HYST = V<sub>DD</sub>) by means of the CMOS compatible HYST input pin. Do not let the HYST pin float as this could cause increase supply current. The hysteresis does not depend on the part’s programmed trip threshold.

**Table 1. Factory–Programmed Threshold Range**

Part Number	Threshold (T <sub>TH</sub> ) Range
NCT51	+45°C < T <sub>TH</sub> < +115°C
NCT52	+45°C < T <sub>TH</sub> < +115°C

### Thermal Considerations

With a very low 17  $\mu$ A supply current, the NCT51 and NCT52 dissipates very little power. Thus, the die temperature is basically the same as the package temperature. To minimize the error in temperature readings, the load current should be limited to a few milliamps. As an example, the typical thermal resistance of a 5–Pin SOT–23A package is 140°C/W. If the NCT51 had to sink 1.0 mA, and the output voltage is guaranteed to be less than 0.3 V, then an additional 0.3 mW of power is dissipated within the IC. This corresponds to a 0.042°C rise in die temperature in the 5–Pin SOT–23A.

## NCT51, NCT52

Temperature monitoring accuracy depends on the thermal resistance between the device being monitored and the temperature switch die. Heat flows primarily through the leads onto the die. Pin 2 provides the lowest thermal resistance to the die. To achieve the best temperature monitoring results, the NCT51 and NCT52 should be placed closest to the device being monitored. In addition, a short and wide copper trace from Pin 2 to the device should be used. In some cases, the 5-Pin SOT-23A

package can be placed directly under the socketed microprocessor for improved thermal contact.

### APPLICATIONS

The NCT51 has an open drain output and is therefore intended to interface as a microprocessor reset input. Moreover, the combination of these two devices can be used to implement a temperature window alarm by wire-ORing the outputs and using an external pull up resistor. (See Figure 1)

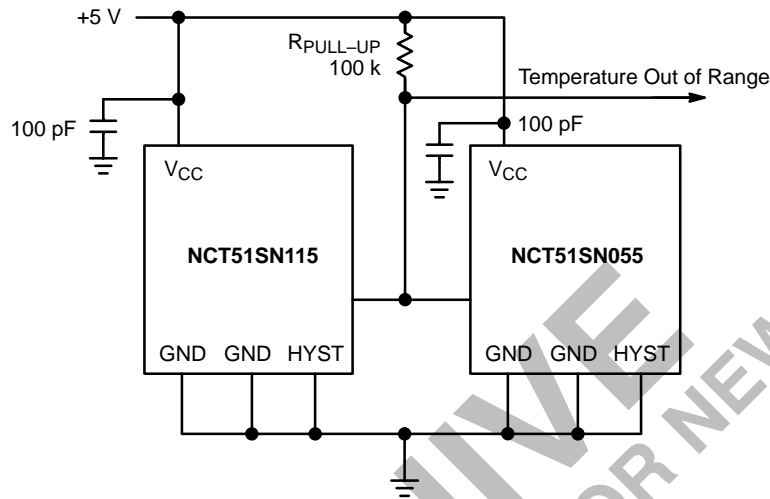

Figure 1. Over and Under Temperature Alarm

The NCT52 can be used to control a DC fan. The fan turns on when the sensed temperature rises above the factory set threshold and remains on until the temperature falls below threshold minus the hysteresis selected. An additional fail

safe measure could be designed by using a second NCT52 with a higher temperature threshold to alert the user of an impending thermal shutdown, should the temperature continue to rise. (See Figure 2)

# NCT51, NCT52

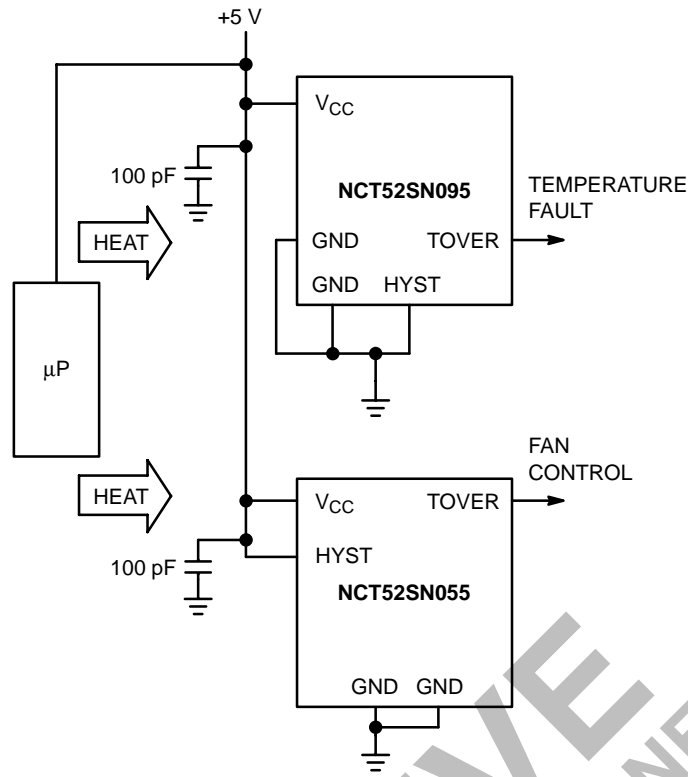

Figure 2. Fan Control Circuit with Over Temperature Alert

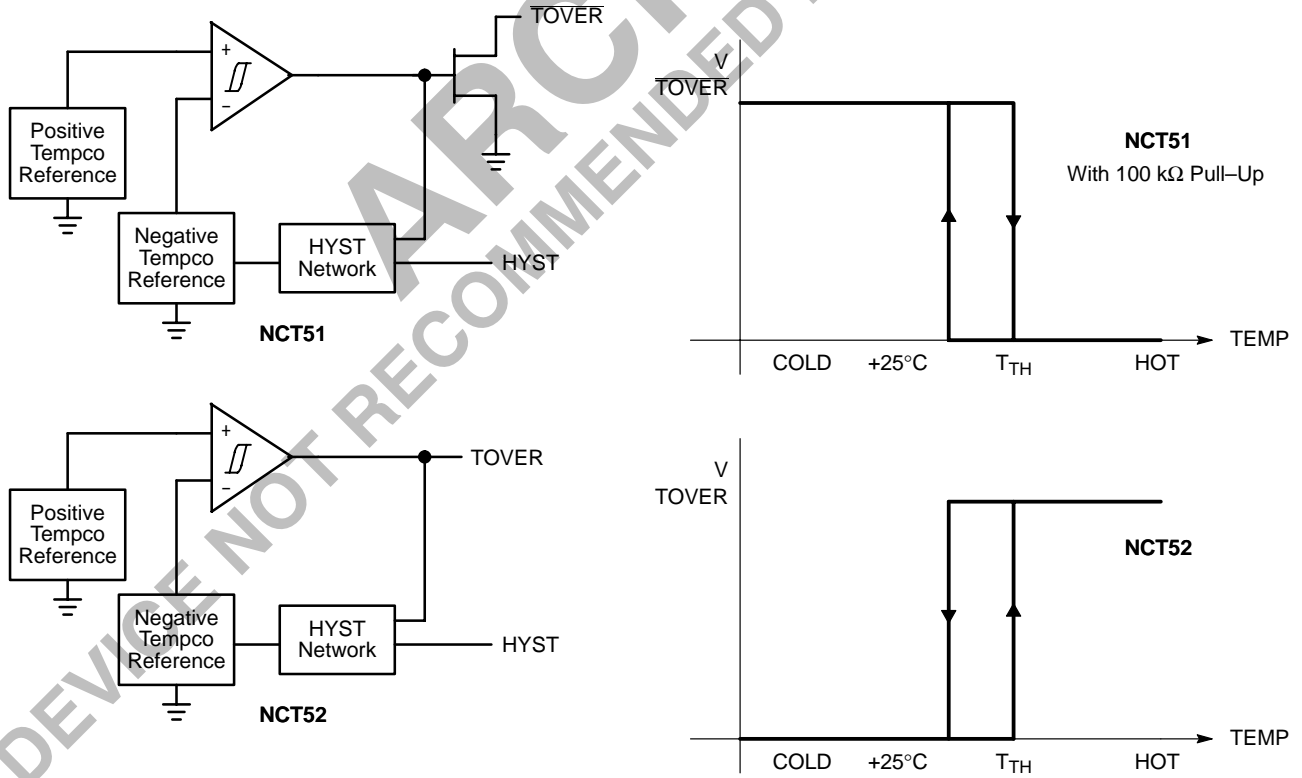

Figure 3. Functional Block Diagrams

# NCT51, NCT52

## TYPICAL CHARACTERISTICS

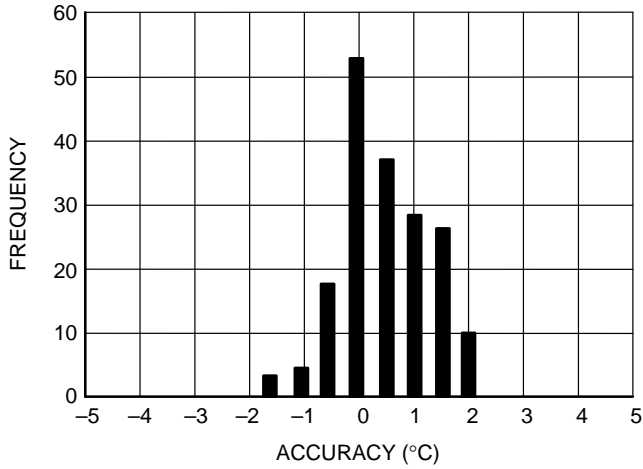

Figure 4. Trip Threshold Accuracy

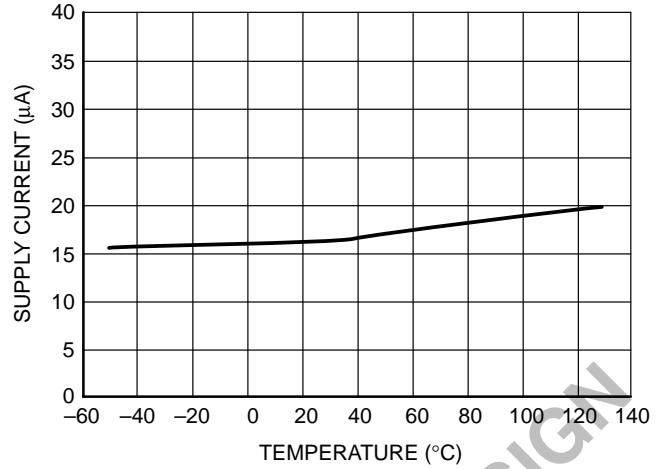

Figure 5. Supply Current vs. Temperature

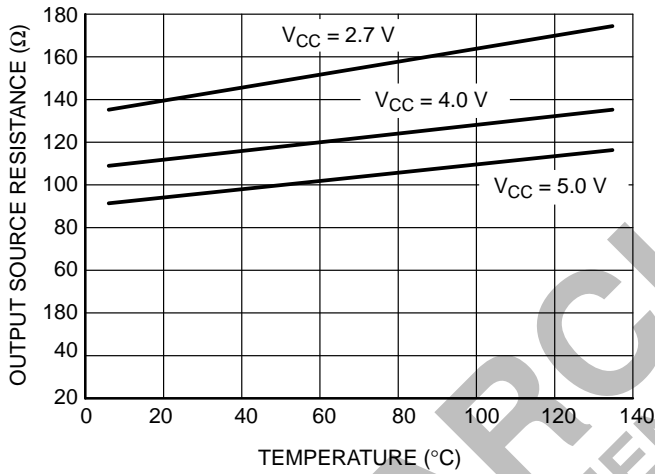

Figure 6. NCT52 Output Source Resistance vs. Temperature

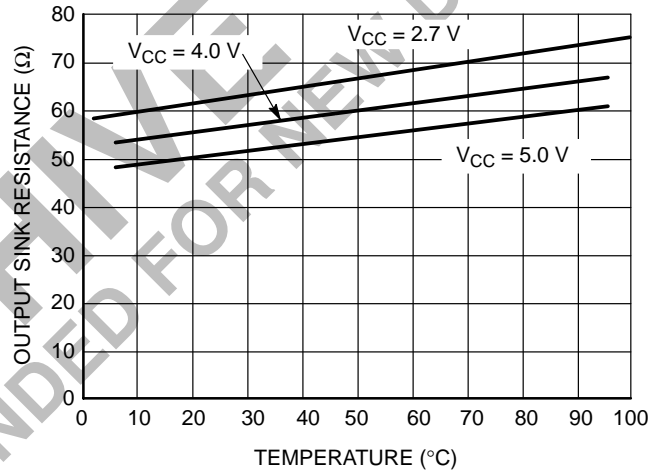

Figure 7. Output Sink Resistance vs. Temperature

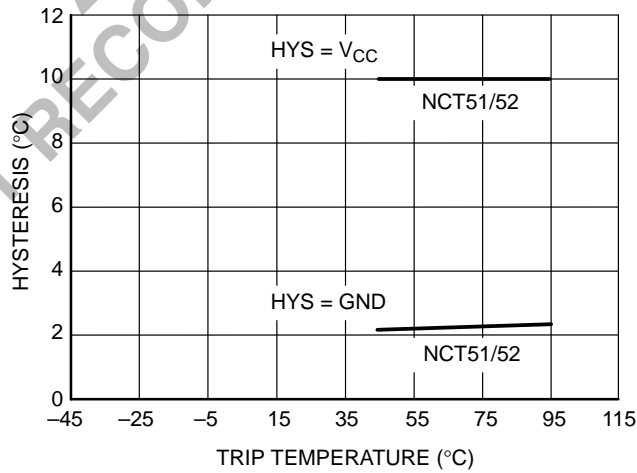
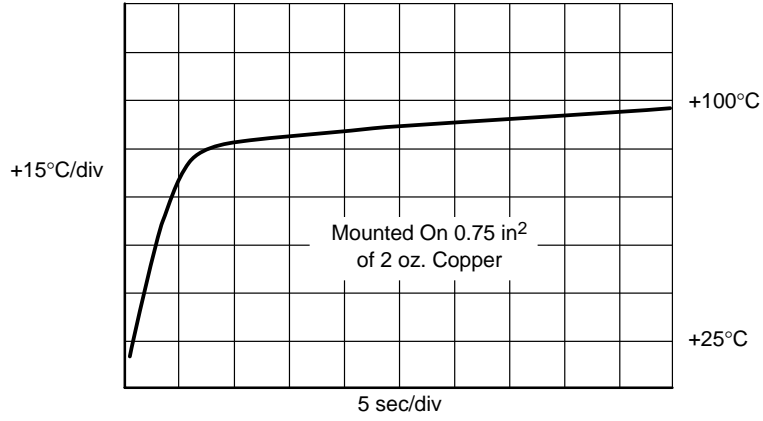

Figure 8. Hysteresis vs. Trip Temperature

# NCT51, NCT52

## TYPICAL CHARACTERISTICS



**Figure 9. SOT-23 Thermal Step Response in Perfluorinated Fluid**

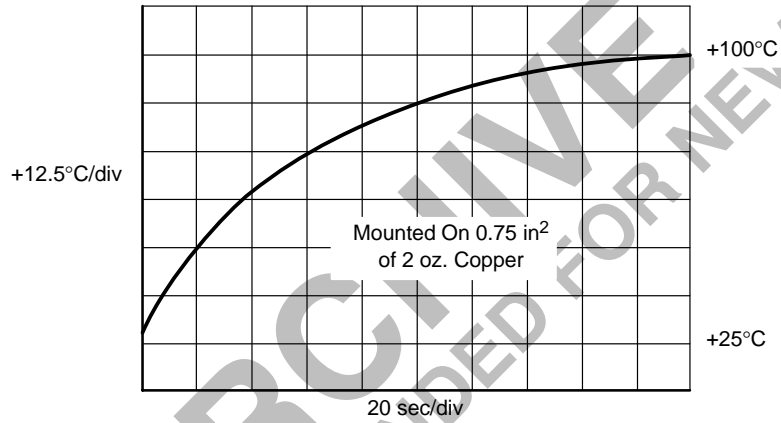
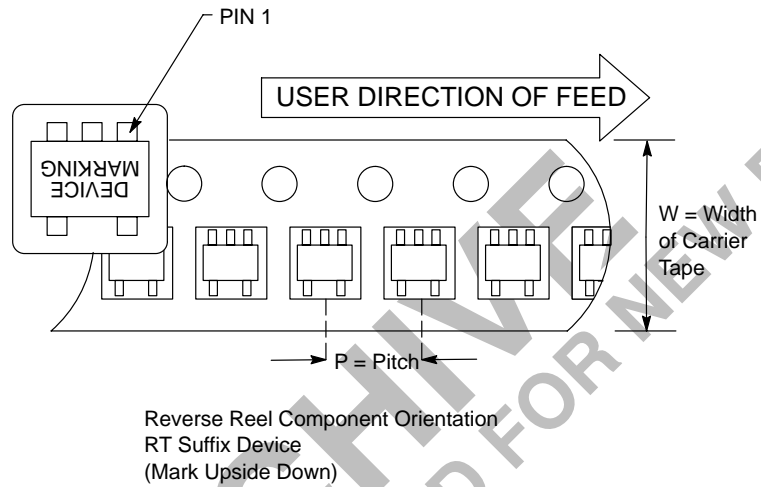
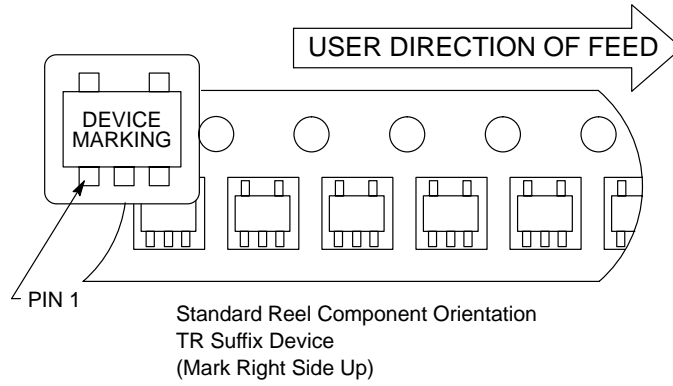

**Figure 10. SOT-23 Thermal Step Response in Still Air**

ARCTIVE  
DEVICE NOT RECOMMENDED FOR NEW DESIGN

## NCT51, NCT52

### Component Taping Orientation for 5-Pin SOT-23A (EIAJ SC-74A) Devices



Carrier Tape, Reel Size, and Number of Components Per Reel

Package	Carrier Width (W)	Pitch (P)	Part Per Full Reel	Reel Size
SOT-23A	8 mm	4 mm	3000	7 inches



# NCT51, NCT52

## MARKING DIAGRAM

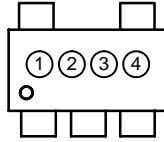

- ① and ② = Two Letter Part Number Codes
- ③ = Year and Two-Month Period Code
- ④ = Lot ID Number

## ORDERING INFORMATION

Device	Package	Standard Temperature Threshold	Output Stage	Marking ① and ②	Shipping
NCT51SN055T1	5-Pin SOT-23A	55°C	Open Drain	HB	3000 Units Tape and Reel
NCT51SN095T1		95°C	Open Drain	HF	
NCT51SN115T1		115°C	Open Drain	HH	
NCT52SN055T1		55°C	Push/Pull	JB	
NCT52SN095T1		95°C	Push/Pull	JF	
NCT52SN115T1		115°C	Push/Pull	JH	

ARCHIVE

DEVICE NOT RECOMMENDED FOR NEW DESIGN

**Notes**

ARCHIVE  
DEVICE NOT RECOMMENDED FOR NEW DESIGN

# NCT51, NCT52

## PACKAGE DIMENSIONS

SOT-23  
 SN SUFFIX  
 CASE 1212-01  
 ISSUE O

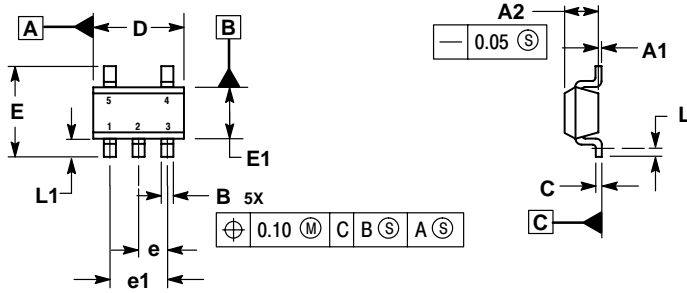

NOTES:

1. DIMENSIONS ARE IN MILLIMETERS.
2. INTERPRET DIMENSIONS AND TOLERANCES PER ASME Y14.5M, 1994.
3. DATUM C IS A SEATING PLANE.

MILLIMETERS		
DIM	MIN	MAX
A1	0.00	0.10
A2	1.00	1.30
B	0.30	0.50
C	0.10	0.25
D	2.90	3.00
E	2.50	3.10
E1	1.50	1.80
e	0.95 BSC	
e1	1.90 BSC	
L	0.20	
L1	0.45	0.75

ARCHIVE

DEVICE NOT RECOMMENDED FOR NEW DESIGN

ARCHIVE  
RECOMMENDED FOR NEW DESIGN

**ON Semiconductor** and  are registered trademarks of Semiconductor Components Industries, LLC (SCILLC). SCILLC reserves the right to make changes without further notice to any products herein. SCILLC makes no warranty, representation or guarantee regarding the suitability of its products for any particular purpose, nor does SCILLC assume any liability arising out of the application or use of any product or circuit, and specifically disclaims any and all liability, including without limitation special, consequential or incidental damages. "Typical" parameters which may be provided in SCILLC data sheets and/or specifications can and do vary in different applications and actual performance may vary over time. All operating parameters, including "Typicals" must be validated for each customer application by customer's technical experts. SCILLC does not convey any license under its patent rights nor the rights of others. SCILLC products are not designed, intended, or authorized for use as components in systems intended for surgical implant into the body, or other applications intended to support or sustain life, or for any other application in which the failure of the SCILLC product could create a situation where personal injury or death may occur. Should Buyer purchase or use SCILLC products for any such unintended or unauthorized application, Buyer shall indemnify and hold SCILLC and its officers, employees, subsidiaries, affiliates, and distributors harmless against all claims, costs, damages, and expenses, and reasonable attorney fees arising out of, directly or indirectly, any claim of personal injury or death associated with such unintended or unauthorized use, even if such claim alleges that SCILLC was negligent regarding the design or manufacture of the part. SCILLC is an Equal Opportunity/Affirmative Action Employer.

## PUBLICATION ORDERING INFORMATION

### Literature Fulfillment:

Literature Distribution Center for ON Semiconductor  
P.O. Box 5163, Denver, Colorado 80217 USA  
**Phone:** 303-675-2175 or 800-344-3860 Toll Free USA/Canada  
**Fax:** 303-675-2176 or 800-344-3867 Toll Free USA/Canada  
**Email:** ONlit@hibbertco.com

**N. American Technical Support:** 800-282-9855 Toll Free USA/Canada

**JAPAN:** ON Semiconductor, Japan Customer Focus Center  
4-32-1 Nishi-Gotanda, Shinagawa-ku, Tokyo, Japan 141-0031  
**Phone:** 81-3-5740-2700  
**Email:** r14525@onsemi.com

**ON Semiconductor Website:** <http://onsemi.com>

For additional information, please contact your local Sales Representative.