

Features

Regulated Converters

- 6-Side Shielding
- External ON/OFF control
- 1.6kVDC Isolation
- UL/CSA/EN-60950-1 Certified
- Wide 4:1 Input Voltage Range
- Continuous Short Circuit Protection
- Efficiency up to 91%
- Fixed Switching Frequency

Description

The REC20-xxxxS_DZ -series offer single and dual regulated outputs in a 2"x1" package with 1.6kVDC isolation and are suitable for higher power industrial applications. Remote on/off control is standard. The higher current outputs have raised output voltages to compensate for track losses as standard. The converter is fully certified to UL/EN/IEC safety standards.

Selection Guide

Part Number	Input Voltage Range [VDC]	Output Voltage [VDC]	Output Current [mA]	Efficiency typ. [%]	max. Capacitive Load [μF]
REC20-243.4SZ	9-36	3.4	5000	88	13000
REC20-245.1SZ	9-36	5.1	4000	90	9600
REC20-2412SZ	9-36	12	1667	89.5	1650
REC20-2415SZ	9-36	15	1333	90	1050
REC20-2405DZ	9-36	±5	±2000	87	±4800
REC20-2412DZ	9-36	±12	±834	89	±625
REC20-2415DZ	9-36	±15	±667	89	±525
REC20-483.4SZ	18-75	3.4	5000	88	13000
REC20-485.1SZ	18-75	5.1	4000	90	9600
REC20-4812SZ	18-75	12	1667	89.5	1650
REC20-4815SZ	18-75	15	1333	90.5	1050
REC20-4805DZ	18-75	±5	±2000	87	±4800
REC20-4812DZ	18-75	±12	±835	90	±625
REC20-4815DZ	18-75	±15	±667	91	±525

Model Numbering



Ordering Examples:

REC20-4812SZ, Single Output, 18-75Vin (4:1) and 12Vout
 REC20-2412DZ, Dual Output, 9-36Vin (4:1) and ±12Vout

REC20-Z

20 Watt

2" x 1"

Single and Dual Output



IEC/EN60950-1 Certified
 UL60950 Certified
 CSA C22.2 NO. 60950 Certified
 EN55022 Certified

Specifications (measured @ $t_a = 25^\circ\text{C}$, nominal input voltage, full load and after warm up unless otherwise specified)

BASIC CHARACTERISTICS					
Parameter	Condition		Min.	Typ.	Max.
Input Voltage Range	nom. $V_{in} = 24\text{V}$ nom. $V_{in} = 48\text{V}$		9VDC 18VDC		36VDC 75VDC
Start/up Time				10ms	
Under Voltage Lockout (UVLO)	nom. $V_{in} = 24\text{V}$	DC-DC ON DC-DC OFF		9VDC 7.5VDC	
	nom. $V_{in} = 48\text{V}$	DC-DC ON DC-DC OFF		18VDC 16VDC	
Output Voltage Trimming	see calculation below				$\pm 10\%$
CTRL ON/OFF	DC-DC ON DC-DC OFF				Open or $2.5\text{V} < V_r < 12\text{V}$ Short or $0\text{V} < V_r < 1.2\text{V}$
Internal Operating Frequency				300kHz	
Minimum Load			0%		
Output Ripple and Noise ⁽¹⁾					100mVp-p

Notes:

Note1: Ripple and Noise is measured with a 20MHz bandwidth and a 0.1µF ceramic capacitor.

Output Voltage Trimming

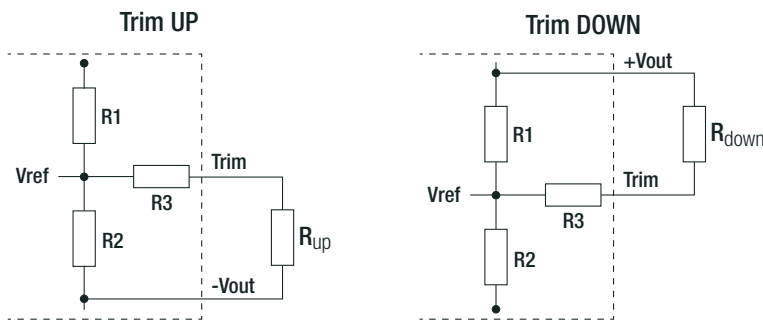

Vout	3.4V	5.1V	12V	15V
R1	4.71 kΩ	2.3 kΩ	19.43 kΩ	25.6 kΩ
R2	2.7 kΩ	2.2 kΩ	5.1 kΩ	
R3	15 kΩ	9.1 kΩ	36 kΩ	
Vref	1.24 V	2.5 V		

Trim Calculation

V_{out} = nom. output voltage

ΔV_{out} = output voltage trim

R_{up} = trim up resistor

R_{down} = trim down resistor

a = trim up factor

b = trim down factor

$$\Delta V_{out} = V_{out} - V_{out_{trimmed}}$$

$$R_{up} = q \frac{a \cdot R_2}{R_2 - a} - R_3 = k\Omega$$

$$R_{down} = q \frac{b \cdot R_1}{R_1 - b} - R_3 = k\Omega$$

$$a = q \frac{V_{ref}}{(V_{out} + \Delta V_{out}) - V_{ref}} - r \cdot R_1 = k\Omega$$

$$b = q \frac{(V_{out} + \Delta V_{out}) - V_{ref}}{V_{ref}} - r \cdot R_2 = k\Omega$$

Trim Up:

$V_{out} = 5.1\text{V}$, $\Delta V_{out} = 0.51\text{V}$ (10%), $V_{ref} = 2.5\text{V}$

$$a = q \frac{2.5\text{V}}{(5.1\text{V} + 0.51\text{V}) - 2.5\text{V}} - r \cdot 2.3\text{k}\Omega = \mathbf{1.843\text{k}\Omega}$$

$$R_{up} = q \frac{1.843\text{k}\Omega \cdot 2.2\text{k}\Omega}{2.2\text{k}\Omega - 1.843\text{k}\Omega} - 9.1\text{k}\Omega = \mathbf{2.255\text{k}\Omega}$$

Trim down:

$V_{out} = 5.1\text{V}$, $\Delta V_{out} = -0.51\text{V}$ (-10%), $V_{ref} = 2.5\text{V}$

$$b = q \frac{[5.1\text{V} + (-0.51\text{V})] - 2.5\text{V}}{2.5\text{V}} - r \cdot 2.2\text{k}\Omega = \mathbf{1.839\text{k}\Omega}$$

$$R_{down} = q \frac{1.839\text{k}\Omega \cdot 2.3\text{k}\Omega}{2.3\text{k}\Omega - 1.839\text{k}\Omega} - 9.1\text{k}\Omega = \mathbf{0.080\text{k}\Omega}$$

continued on next page

Specifications (measured @ $t_a = 25^\circ\text{C}$, nominal input voltage, full load and after warm up unless otherwise specified)

Efficiency vs. Load

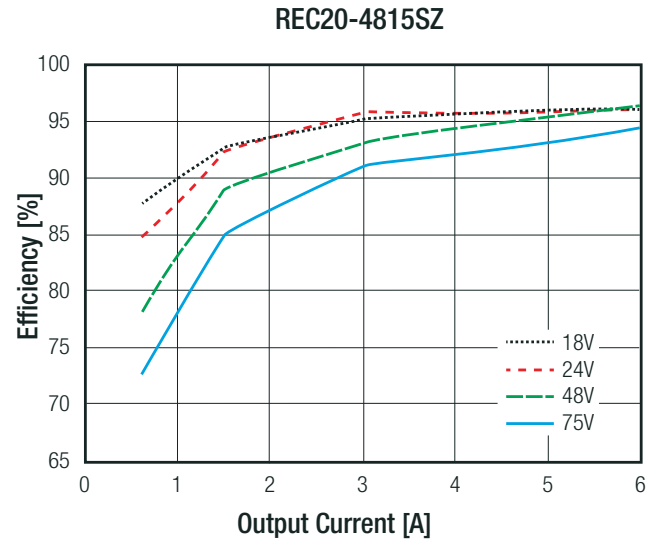
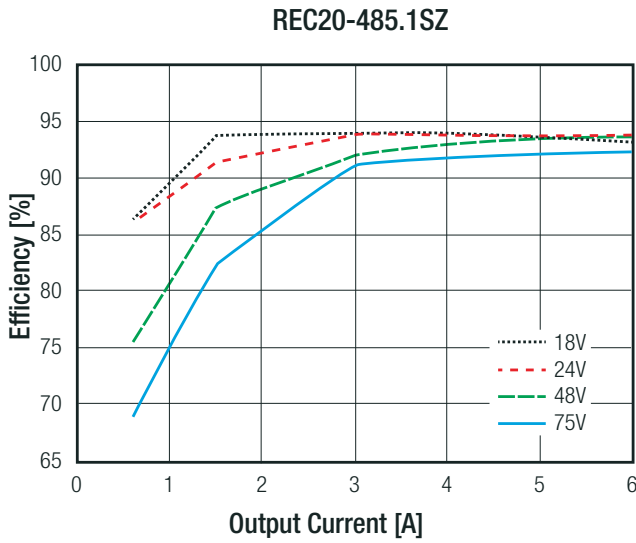

REGULATIONS

Parameter	Condition	Type	Values
Output Accuracy			$\pm 1.0\%$ max.
Line Regulation	low line to high line, full load		$\pm 0.2\%$ max.
Load Regulation	0% to 100% load	single output	$\pm 0.5\%$ max.
		dual output	$\pm 1.0\%$ max.
Cross Regulation	25% to 100% load	dual output	$\pm 5.0\%$ max.
Transient Response Recovery Time	25% load step change		250 μs typ.

Deviation vs. Load

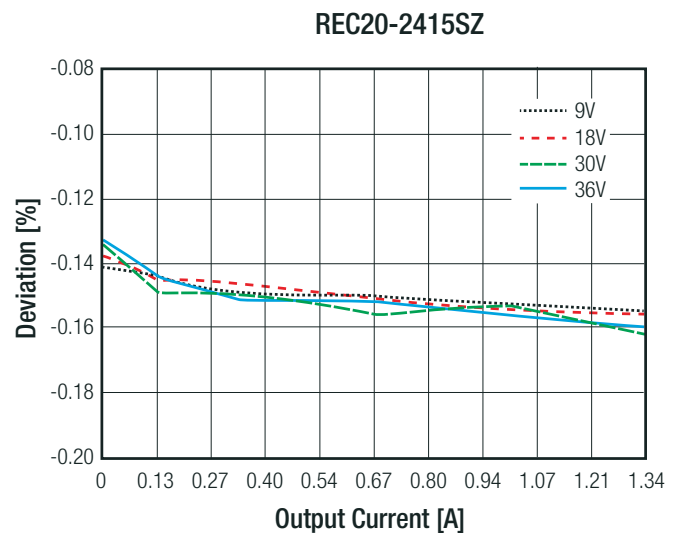
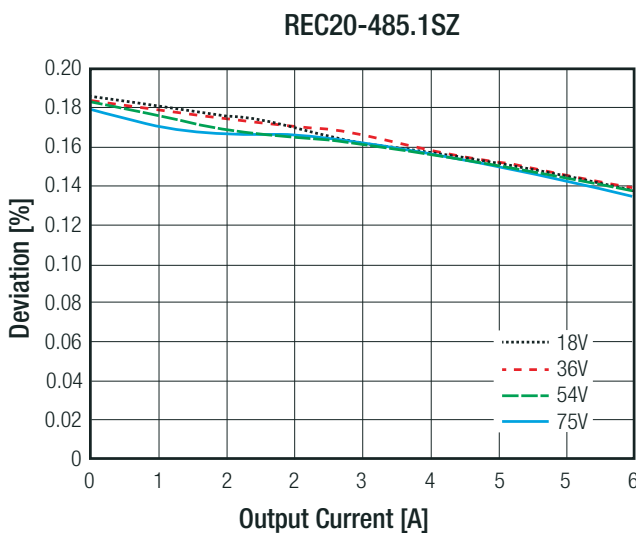

Specifications (measured @ $t_a = 25^\circ\text{C}$, nominal input voltage, full load and after warm up unless otherwise specified)

PROTECTIONS			
Parameter	Condition		Value
Short Circuit Protection (SCP)	below 100mΩ		continuous, automatic recovery
Over Voltage Protection (OVP)	Zener Diode Clamp	3.4Vout	4.5VDC typ.
		5.1Vout	7VDC typ.
		12Vout	16VDC typ.
		15Vout	20VDC typ.
Over Load Protection (OLP)			180% typ.
Isolation Voltage	I/P to O/P	tested for 1 minute	1.6kVDC
Isolation Capacitance			1200pF typ.
Isolation Resistance			1GΩ min.

ENVIRONMENTAL			
Parameter	Condition		Value
Operating Temperature Range	with derating (see graph)		-40°C to +100°C
Maximum Case Temperature			+105°C
Temperature Coefficient			0.02%/°C typ.
Thermal Impedance	natural convection (0.1m/s)		12°C/W
Operating Altitude			5000m
Operating Humidity	non-condensing		5% - 95% RH max.
Vibration			MIL-STD-202G
MTBF	according to MIL-HDBK-217F G.B., +25°C, referring to REC20-485.1SZ		1098 x 10 ³ hours

Derating Graph

@ nominal input voltage, full load and natural convection (0.1m/s)

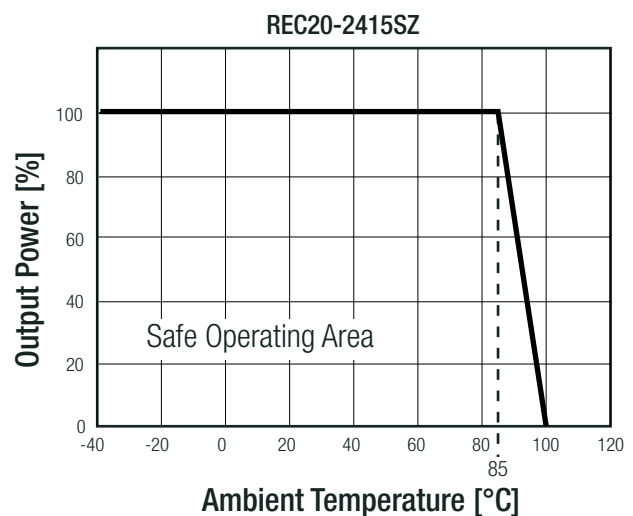
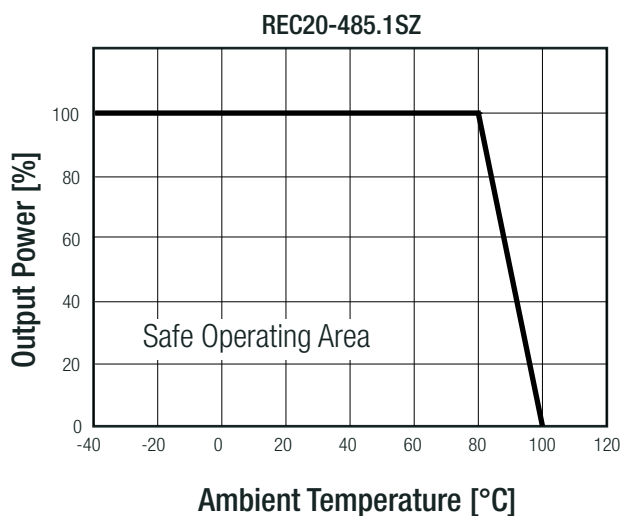

Notes:

Note2: For more details, please contact our technical support service at techsupportAT@recom-power.com

Specifications (measured @ $t_a = 25^\circ\text{C}$, nominal input voltage, full load and after warm up unless otherwise specified)

SAFETY AND CERTIFICATIONS

Certificate Type	Report / File Number	Standard
CB General Safety	E224736	IEC60950-1, 2nd Edition, 2013
UL General Safety		UL60950-1, 2nd Edition, 2014
EN General Safety		EN60950-1, 2nd Edition, 2013
CAN/CSA General Safety		C22.2 No. 60950-1-07, 2014

EMC Compliance	Condition	Standard / Criterion
EMI	without external filter	EN55022, Class A
	with external filter (see filter suggestions)	EN55022, Class B
ESD	Air: $\pm 8\text{kV}$; Contact: $\pm 4\text{kV}$	EN61000-4-2, Criteria B
Radiated Immunity	10V/m	EN61000-4-3, Criteria A
Fast Transient	$\pm 1\text{kV}$	EN61000-4-4, Criteria B
Surge ⁽³⁾	$\pm 1\text{kV}$	EN61000-4-5, Criteria A
Conducted Immunity	10Vr.m.s	EN61000-4-6, Criteria A
Power Magnetic Field	50Hz 1A/m (r.m.s)	EN61000-4-8, Criteria A

Notes:

Note3: An external MOV is required if the module has to meet EN61000-4-5. The MOV suggest: NichTek SVI32-380

EMC Filtering - Suggestions for Class B

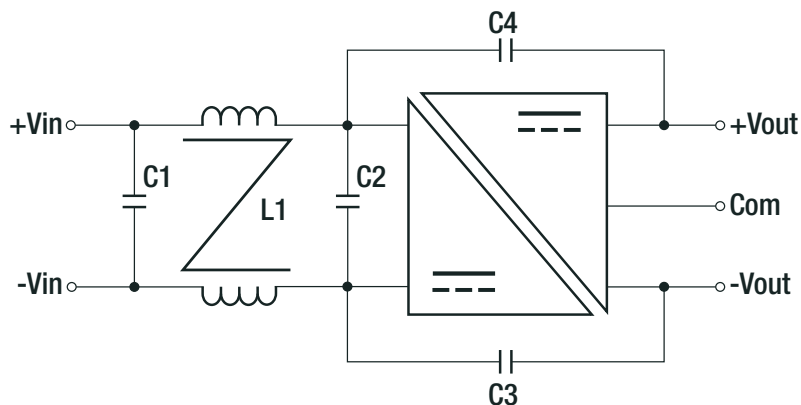

MODEL	C1	C2	L1	C3	C4
REC20-24xxS(D)Z	4.7 μF /50V	4.7 μF /50V	1.5mH CMC	1000pF/2kV	1000pF/2kV
REC20-48xxS(D)Z	2.2 μF /100V	2.2 μF /100V	2.0mH CMC	1000pF/2kV	1000pF/2kV

DIMENSION and PHYSICAL CHARACTERISTICS

Parameter	Type	Value
Material	Case	nickel plated copper
	Base	non conductive black plastic
	PCB	FR4
	Potting	silicone (UL94 V-0)
Package Dimension (LxWxH)		50.8 x 25.4 x 10.2mm
Package Weight		27g typ.

continued on next page

Specifications (measured @ $t_a = 25^\circ\text{C}$, nominal input voltage, full load and after warm up unless otherwise specified)

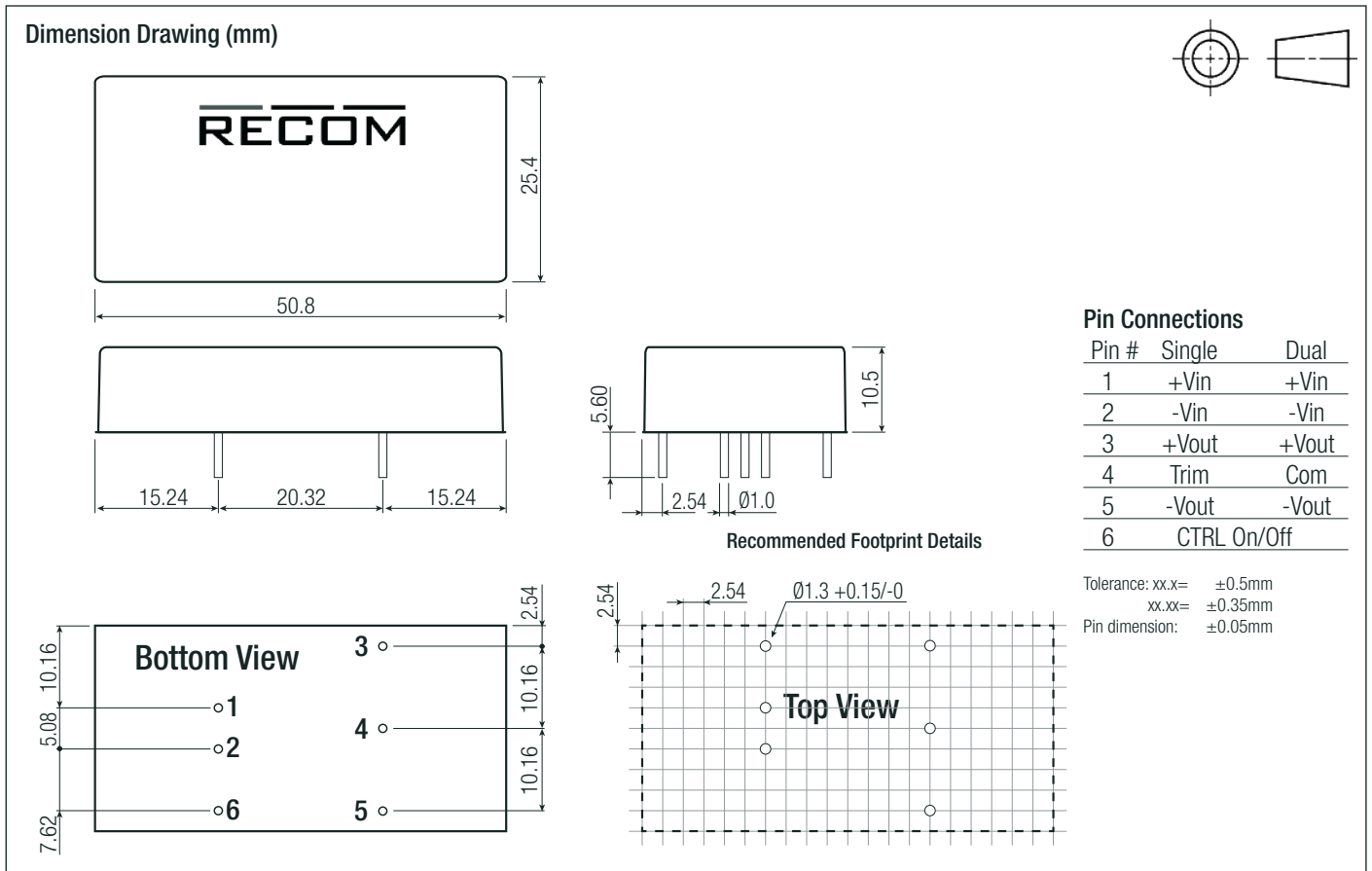

PACKAGING INFORMATION

Packaging Dimension (LxWxH)	Tube	520.0 x 54.5 x 21.0mm
Packaging Quantity		18pcs
Storage Temperature Range		-55°C to +125°C