

REVISIONS					
REV	ECO	DESCRIPTION	DATE	BY	APPR
A1	-	FIRST RELEASE	Jan.12.2018	White	Tommy

E type, Normal Key

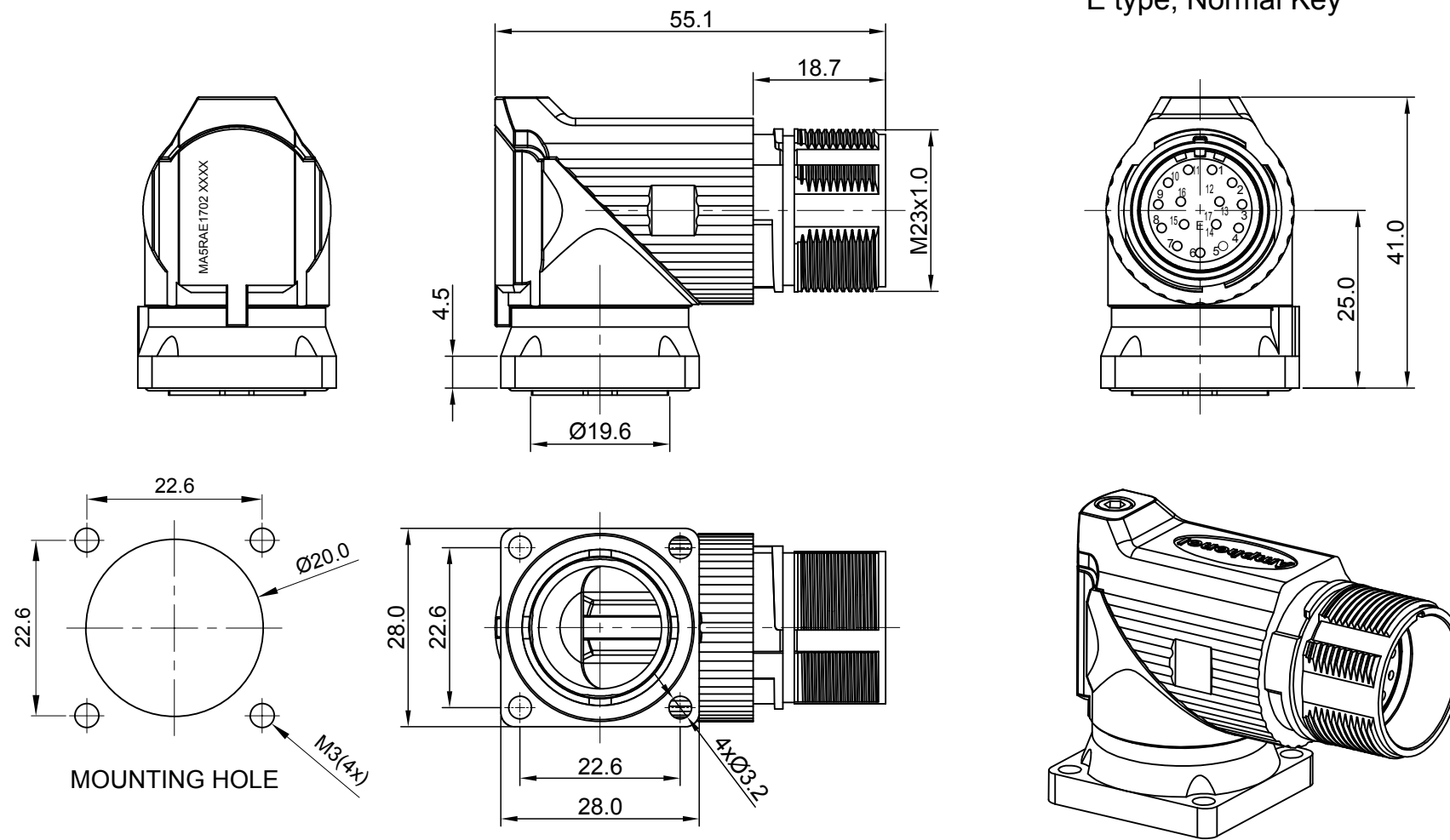

NOTES: UNLESS OTHERWISE SPECIFIED

- MATERIAL:
INSULATION INSERT: PA66,UL94 V0
SEAL: VITON
HOUSING BODY: ZINC DIE CAST, NICKEL PLATED
CONTACT: COPPER ALLOY, GOLD PLATED
- SPECIFICATIONS:
2.1 CURRENT RATING: 9 AMPS
2.2 VOLTAGE RATING: 125 V AC/DC
2.3 OPERATING TEMPERATURE: -20°C TO +130°C
2.4 DIELECTRIC WITHSTANDING VOLTAGE: LESS THAN 2 MILLIAMPS CURRENT LEAKAGE @ 2500 VOLTS AC.
2.5 DEGREE OF PROTECTION: IP67 (MATED CONDITION)
2.6 DEGREE OF POLLUTION: 3 PER UL840
2.7 OVERVOLTAGE CATEGORY: III PER UL840
2.8 MATING CYCLE DURABILITY: >500 CYCLES
2.9 RoHS COMPLIANT
- ALL DIMENSIONS ARE FOR REFERENCE USE ONLY.

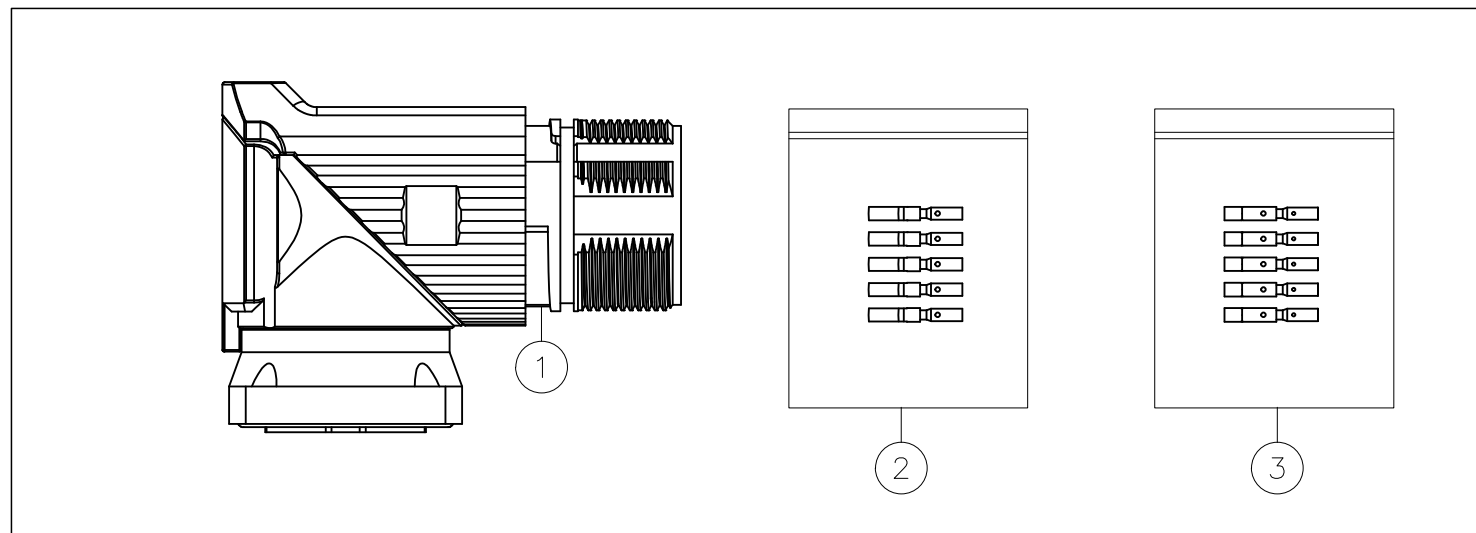

QUANTITY	PART NUMBER	DESCRIPTION	ITEM
17	SC000030	CONTACT, SOCKET, Ø1.0mm,CRIMP 24~28AWG	3
17	SC000044	CONTACT, SOCKET, Ø1.0mm,CRIMP 18~22AWG	2
1	MA5RAE1702	CONNECTOR	1

MATERIALS LIST			
SIGNATURES		DATE	
DRAWN: White		Jan.12.2018	
CHECKED: Tod		Jan.12.2018	
ENGINEER:			
APPROVAL: Tommy		Jan.12.2018	
MATERIAL SPECIFICATIONS:			
CUSTOMER:			
THIS DRAWING IS SUPPLIED FOR INFORMATION ONLY. DESIGN FEATURES, SPECIFICATIONS AND PERFORMANCE DATA SHOWN HEREON ARE THE PROPERTY OF THE AMPHENOL CORPORATION. NO RIGHTS OF REPRODUCTION ARE IMPLIED. ALL DIMENSIONS ARE SUBJECT TO NORMAL MANUFACTURING VARIATIONS.			
SIZE	TYPE	DWG NO:	REVISION
B	C-	MA5RAE1702S-KIT	A1
SCALE: NONE		SHEET 1 OF 1	

TITLE: KIT,M23A,REC.,RA,17P,E TYPE,CHECKMATE
DWG NO: MA5RAE1702S-KIT
REV: A1
SH: 1
OF: 1