

1. Description

The LTPL (LiteOn Power LED) is a revolutionary, energy efficient and ultra compact new light source, combining the lifetime and reliability advantages of Light Emitting Diodes with the brightness of conventional lighting. It gives you total design freedom and unmatched brightness, creating a new opportunities for solid state lighting to displace conventional lighting technologies.

Features

- High power LED light source
- Instant light (less than 100 ns)
- Low voltage DC operated
- Low thermal resistance
- RoHS Compliant
- Lead free reflow solder compatible

Applications

- Portable (flashlight, bicycle)
- Downlighters/Orientation
- Decorative/Entertainment
- Bollards/Security/Garden
- Cove/Undershelf/Task
- Traffic signaling/Beacons/ Rail crossing and Wayside
- Indoor/Outdoor Commercial Residential Architectural
- Edge_lit signs (Exit, point of sale)

2. Outline Dimensions

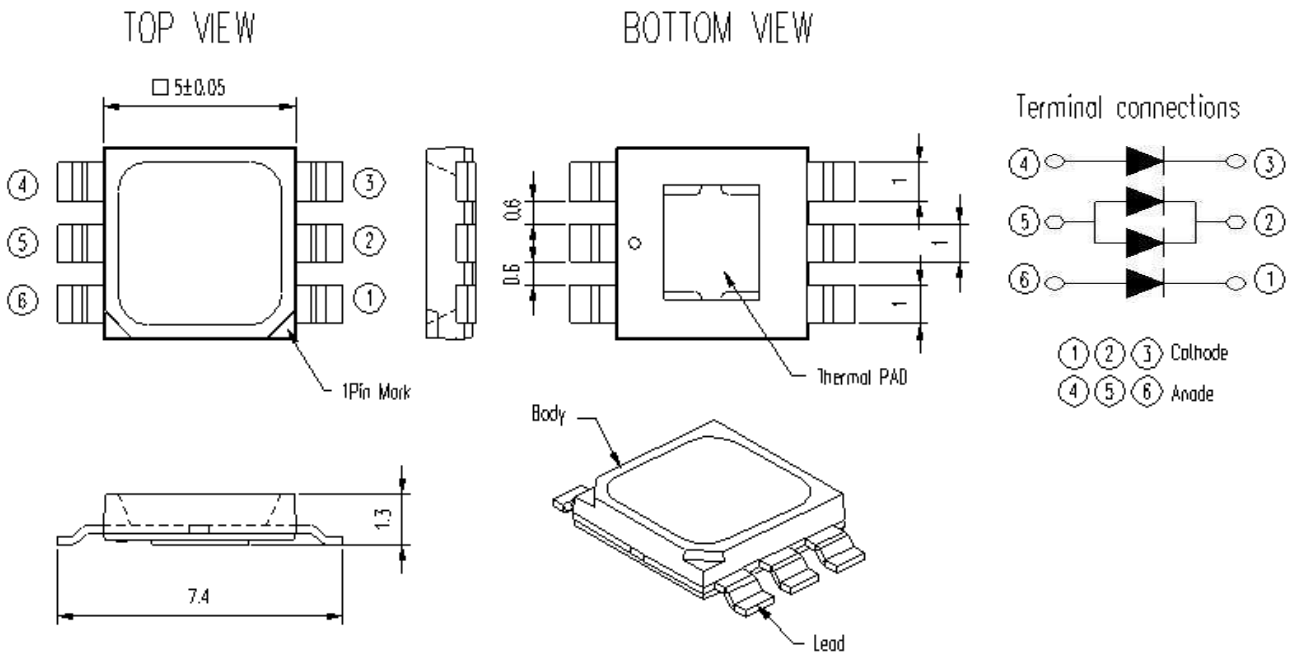

Notes

1. All dimensions are in millimeters.
2. Tolerance is ± 0.2 mm (.008") unless otherwise noted.

3. Rating and Characteristics

Absolute Maximum Ratings at Ta=25°C

| Parameter | Symbol | Rating | Unit |
|--------------------------------------|---------------|-----------|------|
| Power Dissipation | P_o | 2 | W |
| Forward Current | I_F | 500 | mA |
| Forward Pulse Current | I_{FP} | 500 | mA |
| Reverse Voltage | V_R | 5 | V |
| Junction Temperature | T_j | 115 | °C |
| Thermal Resistance, Junction-Case | $R_{th, J-C}$ | 8 | °C/W |
| Thermal Resistance, Junction-Ambient | $R_{th, J-A}$ | 13 | °C/W |
| Operating Temperature Range | T_{opr} | -40 - 85 | °C |
| Storage Temperature Range | T_{stg} | -40 - 100 | °C |

Notes

1. The pulse mode condition is 1/10 duty cycle with 100 msec pulse width.
2. Forbid to operating at reverse voltage condition for long.

Electro-Optical Characteristics at Ta=25°C

| Parameter | Symbol | MIN. | TYP. | MAX. | Test Condition | Unit |
|------------------------------|-------------------|------|-------|------|------------------------|------|
| Forward Voltage | V _F | 2.79 | 3.2 | 3.75 | I _F = 350mA | V |
| | | | 3.4 | | I _F = 500mA | |
| Reverse Current | I _R | | | 100 | V _R = 5V | μA |
| Luminous Flux | Φ _V | | 108 | | I _F = 350mA | lm |
| | | | 145 | | I _F = 500mA | |
| Efficiency | η | | 96 | | I _F = 350mA | lm/W |
| | | | 85 | | I _F = 500mA | |
| Color Rendering | Ra | 65 | 70 | 100 | I _F = 350mA | |
| View Angle | 2θ _{1/2} | | 120 | | I _F = 350mA | ° |
| Chromaticity Coordinates | X | | 0.330 | | I _F = 350mA | |
| | Y | | 0.346 | | | |
| Correlated Color Temperature | CCT | 5300 | | 6000 | | K |

Notes

1. Luminous flux is the total luminous flux output as measured with an integrating sphere.
2. The chromaticity coordinates (x, y) is derived from the CIE 1931 chromaticity diagram.
3. IS CAS140B is for the luminous flux (lm) and the CIE1931 chromaticity coordinates (x, y) testing.
The chromaticity coordinates (x, y) guarantee should be added ± 0.01 tolerance.

Typical Electrical / Optical Characteristics Curves

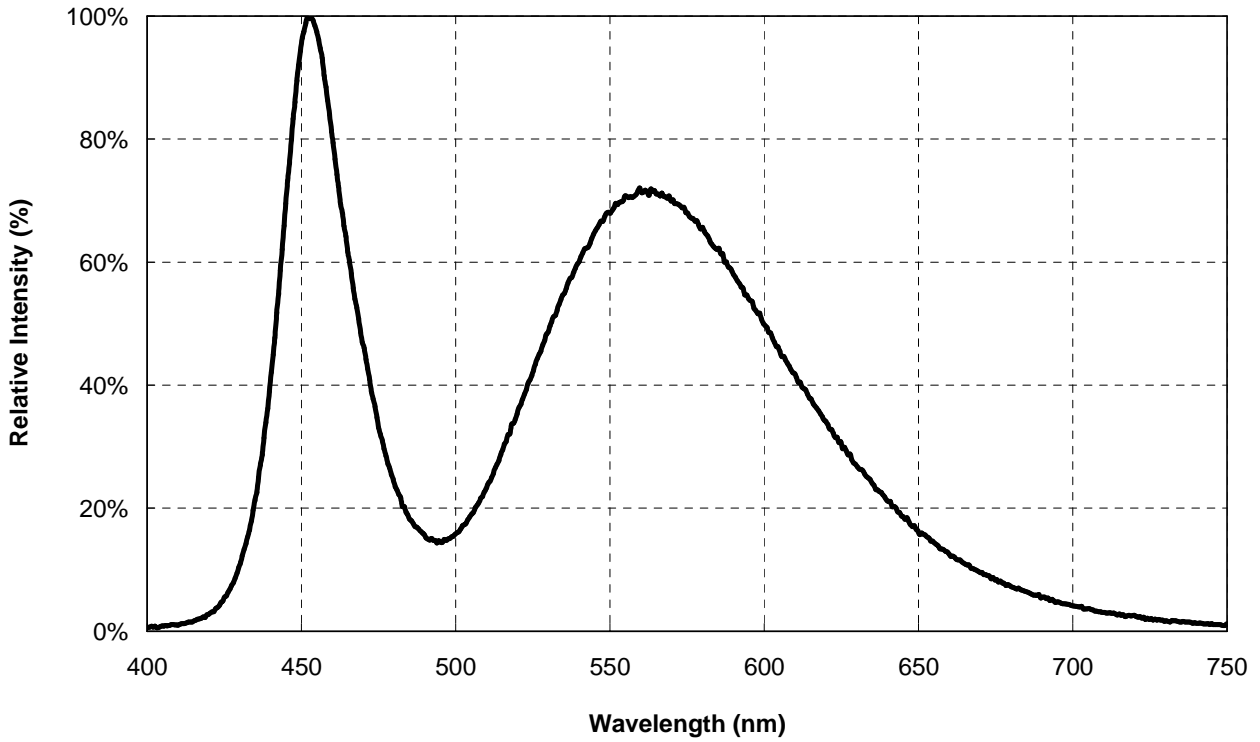

Fig 1. Relative Spectrum of Emission

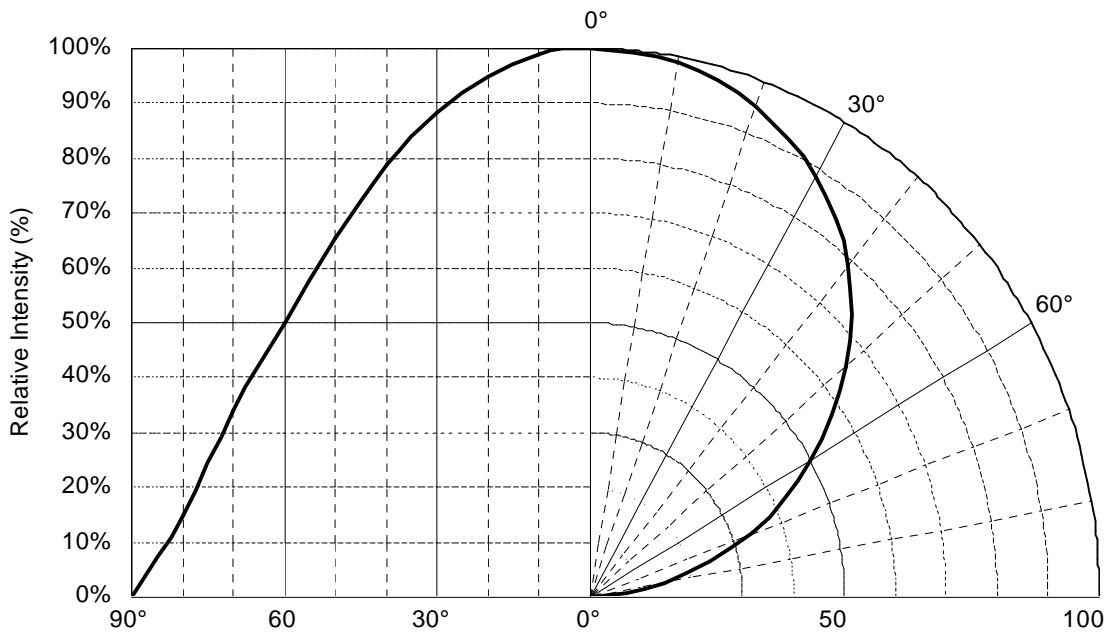

Fig 2. Radiation Characteristics

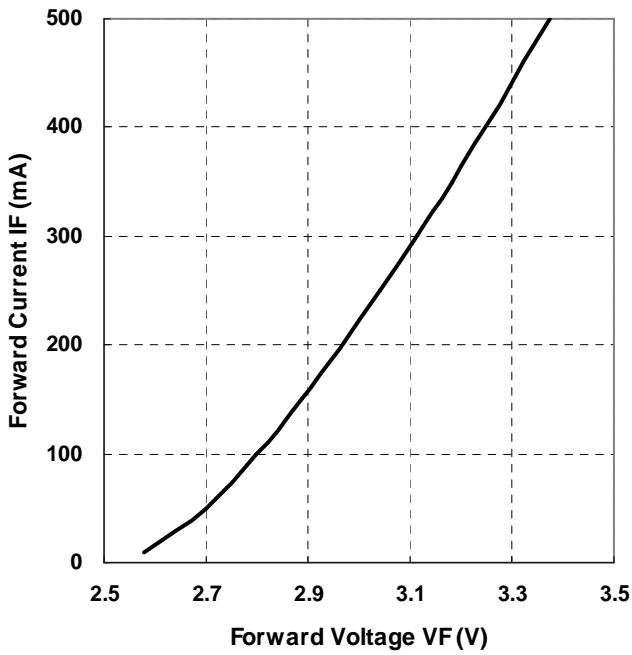

Fig 3. Forward Current

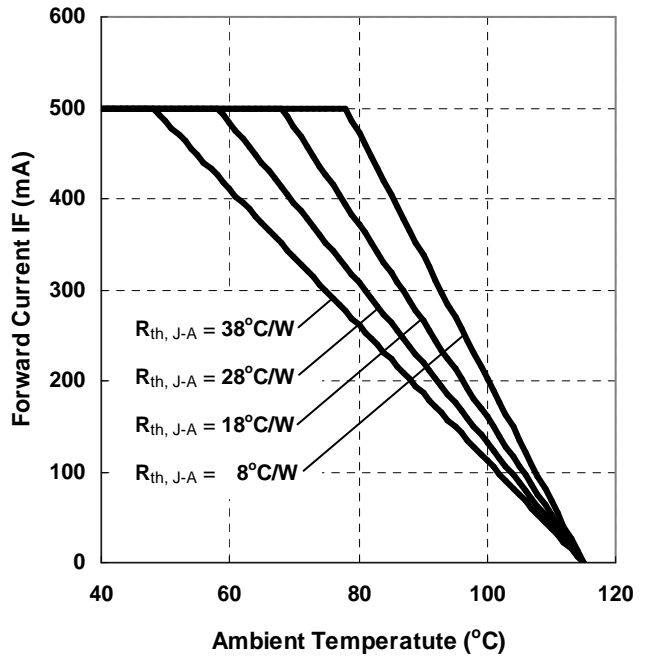

Fig 4. Forward Current Derating Curve

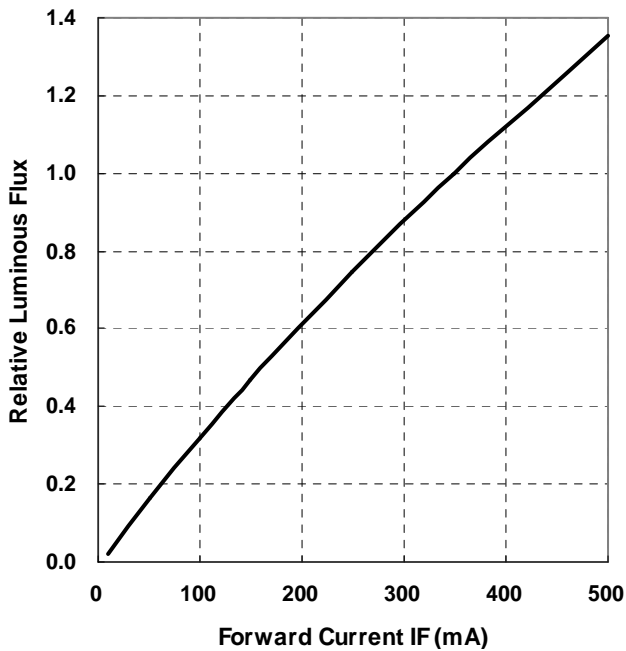

Fig 5. Relative Luminous Flux

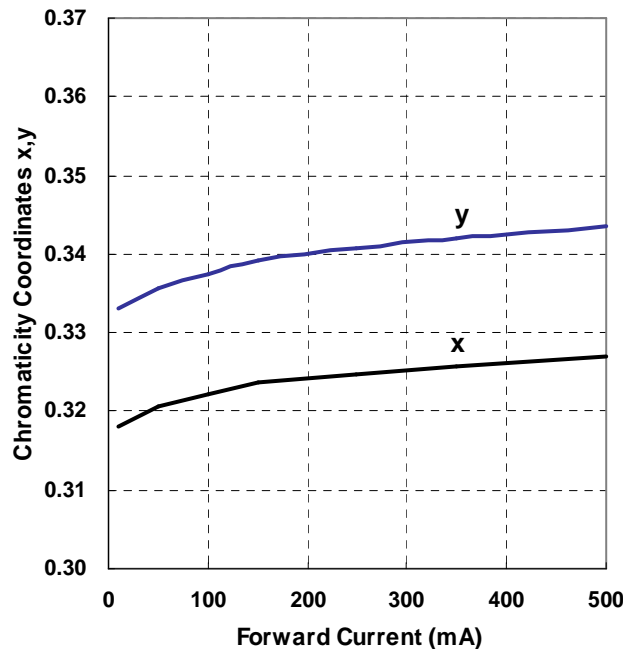

Fig 6. Chromaticity Coordinate Shift

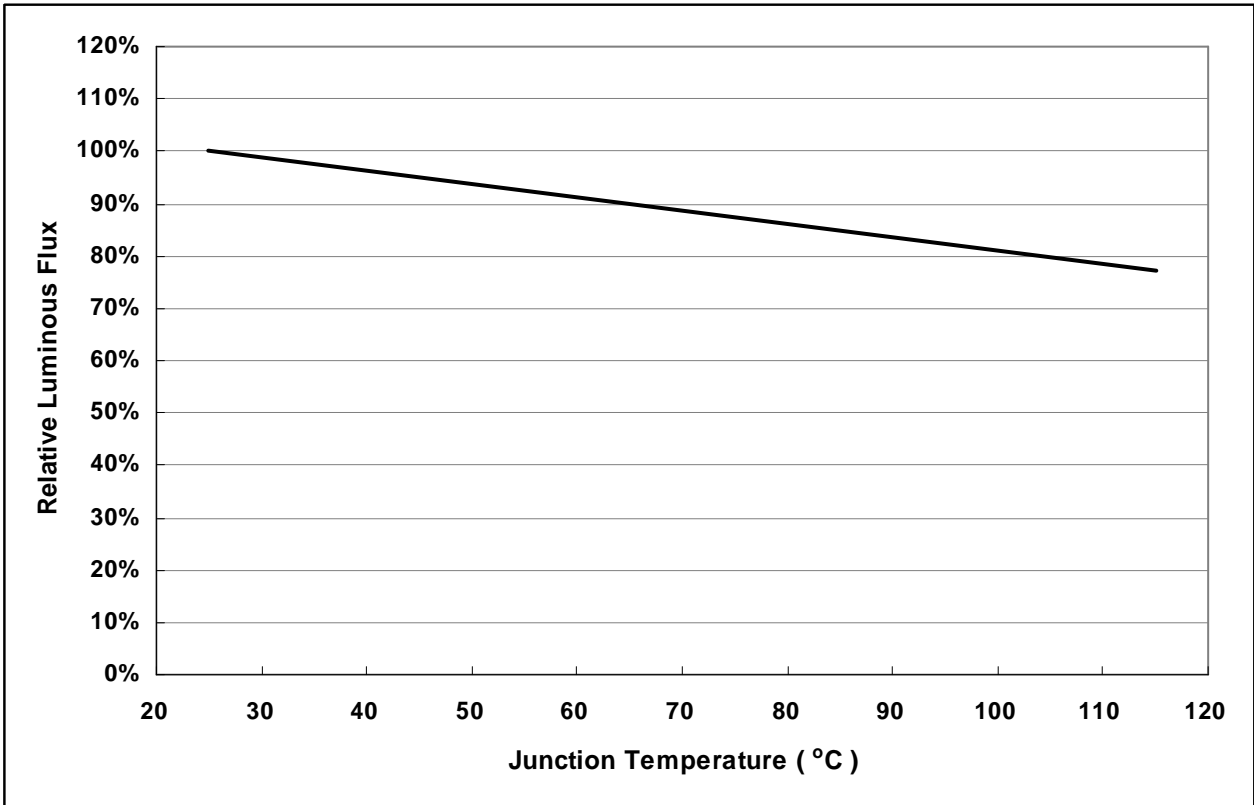

Fig 7. Relative Flux vs. Junction Temperature

4. Category Code Table

| | | |
|----|---|----|
| T2 | H | V1 |
|----|---|----|

Chromaticity Coordinate Categories

| Code | x | y | Code | x | y | Code | x | y |
|------|--------|--------|------|--------|--------|------|--------|--------|
| V1 | 0.3319 | 0.3446 | V2 | 0.3318 | 0.3327 | V3 | 0.3267 | 0.3399 |
| | 0.3320 | 0.3565 | | 0.3319 | 0.3446 | | 0.3263 | 0.3513 |
| | 0.3376 | 0.3616 | | 0.3371 | 0.3493 | | 0.3320 | 0.3565 |
| | 0.3371 | 0.3493 | | 0.3366 | 0.3369 | | 0.3319 | 0.3446 |
| V4 | 0.3270 | 0.3285 | V5 | 0.3215 | 0.3353 | V6 | 0.3222 | 0.3243 |
| | 0.3267 | 0.3399 | | 0.3207 | 0.3462 | | 0.3215 | 0.3353 |
| | 0.3319 | 0.3446 | | 0.3263 | 0.3513 | | 0.3267 | 0.3399 |
| | 0.3318 | 0.3327 | | 0.3267 | 0.3399 | | 0.3270 | 0.3285 |

Forward Voltage Categories

| Code | Min | Max |
|------|------|------|
| G | 2.79 | 3.03 |
| H | 3.03 | 3.27 |
| I | 3.27 | 3.51 |
| K | 3.51 | 3.75 |

Luminous Flux Categories

| Code | Min | Max |
|------|-------|-------|
| U1 | 87.4 | 100.0 |
| U2 | 100.0 | 113.6 |
| V0 | 113.6 | 147.7 |

Notes

1. The chromaticity coordinates is operated performance with forward current 350mA.
2. The luminous flux is operated performance with forward current 350mA.

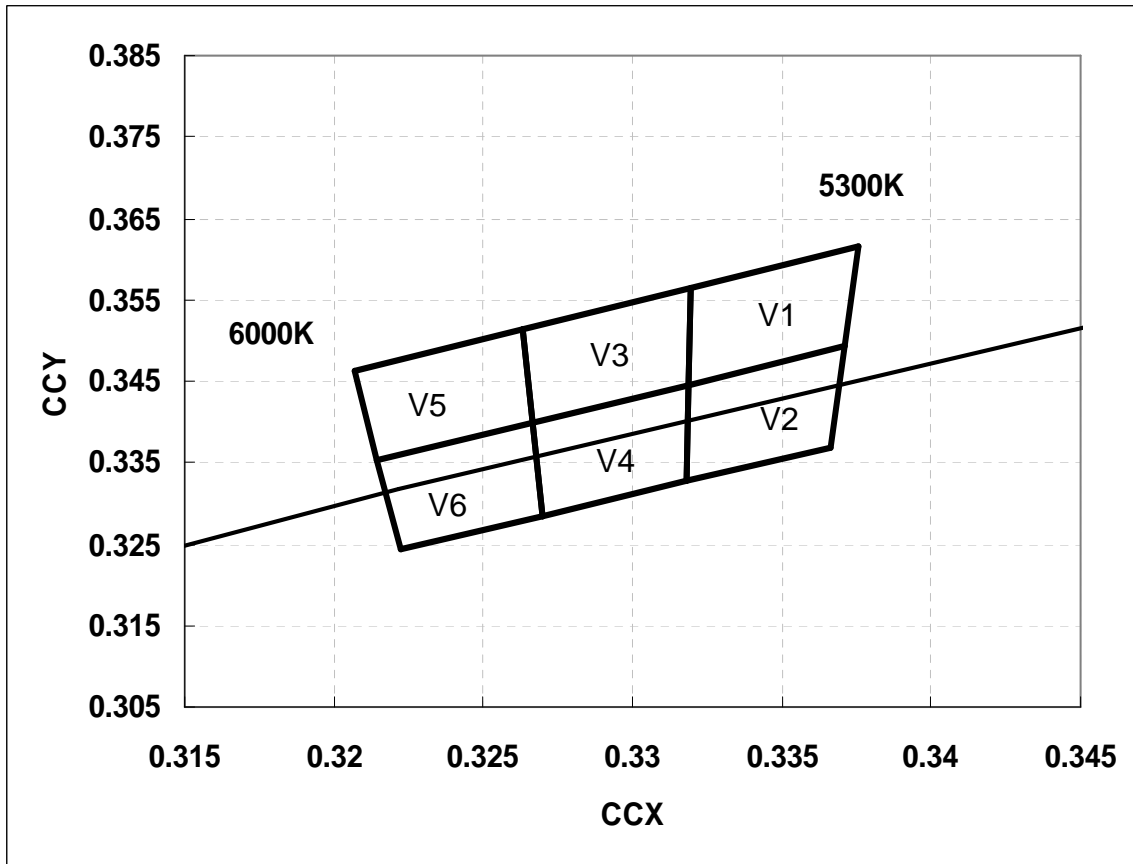

Notes

1. The value is all dies operated performance.
2. The chromaticity coordinates (x, y) is derived from the CIE 1931 chromaticity diagram.
3. IS CAS140B is for the luminous flux (lm) and the CIE1931 chromaticity coordinates (x, y) testing.
The chromaticity coordinates (x, y) guarantee should be added ± 0.01 tolerance.

5. Reflow Soldering Characteristics

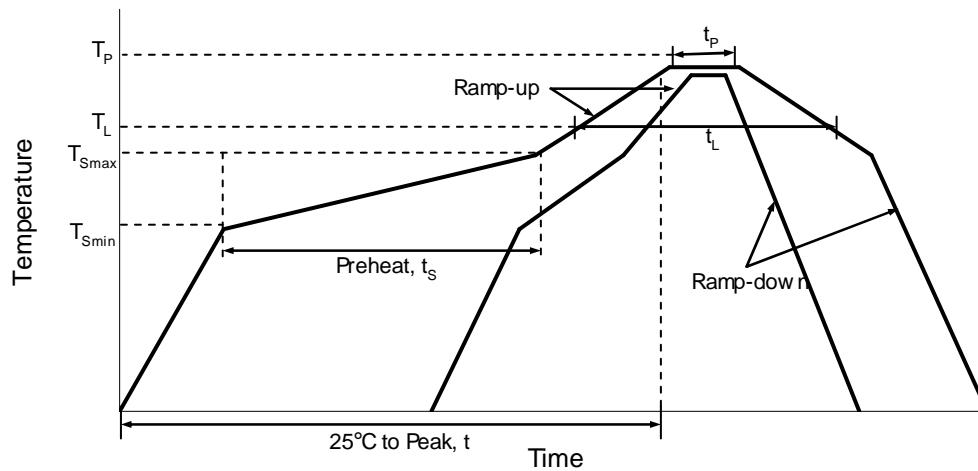

| Profile Feature | Lead Free Assembly |
|--|--------------------|
| Average Ramp-Up Rate (T_{Smax} to T_P) | 3°C / second max |
| Preheat Temperature Min (T_{Smin}) | 150°C |
| Preheat Temperature Max (T_{Smax}) | 200°C |
| Preheat Time (t_{Smin} to t_{Smax}) | 60 – 180 seconds |
| Time Maintained Above Temperature (T_L) | 217°C |
| Time Maintained Above Time (t_L) | 60 – 150 seconds |
| Peak / Classification Temperature (T_P) | 260°C |
| Time Within 5°C of Actual Peak Temperature (t_p) | 5 seconds |
| Ramp – Down Rate | 6°C / second max |
| Time 25°C to Peak Temperature | 8 minutes max |

Notes:

1. The LEDs can be soldered using the reflow soldering or hand soldering method. The recommended hand soldering condition is 350°C max. and 2secs max. for one time only.
2. All temperatures refer to topside of the package, measured on the package body surface.
3. The soldering condition referring to J-STD-020B. If the LEDs were unpacked more than 72hrs, we recommend baking the LEDs at 60°C at least 12 hours before soldering process.
4. The soldering profile could be further referred to different soldering grease material characteristic. The grease vendor will provide this information.
5. A rapid-rate process is not recommended for the LEDs cooling down from the peak temperature.
6. Although the recommended reflow conditions are specified above, the reflow or hand soldering condition at the lowest possible temperature is desirable for the LEDs.
7. LiteOn cannot make a guarantee on the LEDs which have been already assembled using the dip soldering method

6. Recommend Solder Pad

Solder Pad Design

Infrared / vapor phase
Reflow Soldering

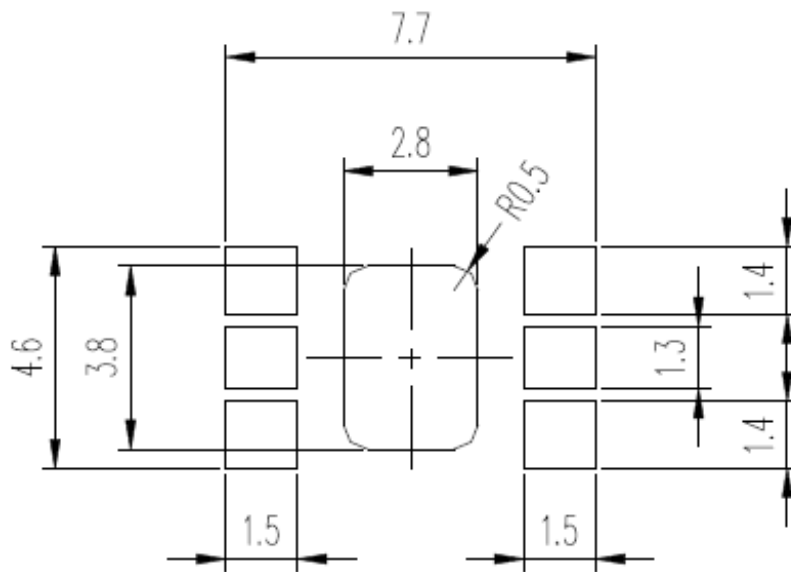

Notes:

1. All dimensions are in millimeters
2. The circle metallization board and lead contact pad is electrically isolated.

7. Package Dimensions of Tape and Reel

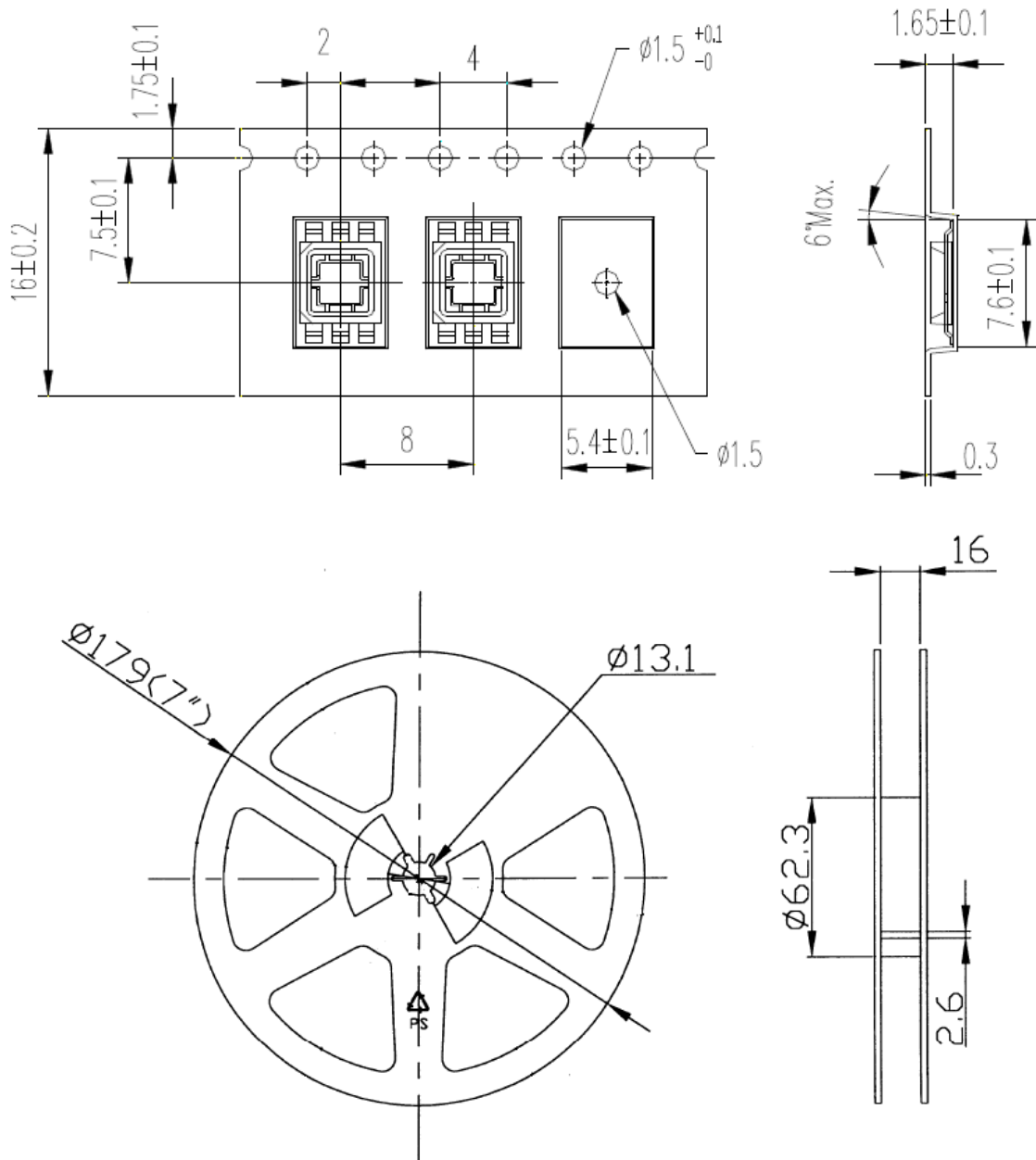

Notes:

1. All dimension are in millimeters. (inches)
2. Empty component pockets sealed with top cover tape.
3. 1000 pieces per 7 inch reel. (Min. packing quantities are 500 pieces for remainders)
4. The maximum number of consecutive missing LED is two.
5. In accordance with EIA-481-1-L23 specifications.

Reliability Test

| Test Item | Test Condition | Test Point | Number of Damaged |
|---|--|------------|-------------------|
| High Temperature Operating Life | 85°C, I _F = 500mA (DC) | 1000 Hours | 0/22 |
| High Temperature Operating Life | 55°C, I _F = 500mA (DC) | 1000 Hours | 0/22 |
| Low Temperature Operating Life | -40°C, I _F = 500mA (DC) | 1000 Hours | 0/11 |
| Wet High Temperature Operation Life | 60°C / 90%RH, I _F = 500mA | 1000 Hours | 0/22 |
| Powered Wet High Temperature Operation Life | 60°C / 90%RH, I _F = 500mA 30min ON/30min OFF | 1000 Hours | 0/22 |
| High Temperature Storage Life | 125°C | 1000 Hours | 0/11 |
| Low Temperature Storage Life | - 40°C | 1000 Hours | 0/11 |
| Thermal Cycle | - 40°C ~100°C 30min dwell, 5 min transfer | 500 cycle | 0/22 |
| Thermal Shock | - 40°C ~120°C 20min dwell, 20 sec transfer | 500 cycle | 0/22 |
| Resistance to Soldering Heat | 265°C, 5secs according to MSL rating | 3 Times | 0/11 |
| Solder ability | T _{sld} = 245±5°C, 3 sec | 1 Time | 0/6 |
| Salt Mist Test | 35°C, 30g/m ² /day | 48 Hours | 0/6 |

Criteria for Judging the Damage

| Item | Symbol | Test Condition | Criteria for Judgment | |
|--------------------|----------------|------------------------|-----------------------|--------------|
| | | | Min. | Max. |
| Forward Voltage | V _f | I _F = 350mA | | U.S.L. x 1.1 |
| Luminous Intensity | L _m | I _F = 350mA | L.S.L. x 0.7 | |

8. Cautions

Application

The LEDs described here are intended to be used for ordinary electronic equipment (such as office equipment, communication equipment and household applications). Consult Liteon's Sales in advance for information on applications in which exceptional reliability is required, particularly when the failure or malfunction of the LEDs may directly jeopardize life or health (such as in aviation, transportation, traffic control equipment, medical and life support systems and safety devices).

Storage

This product is qualified as Moisture Sensitive Level 4 per JEDEC J-STD-020 Precaution when handling this moisture sensitive product is important to ensure the reliability of the product.

The package is sealed:

The LEDs should be stored at 30°C or less and 90%RH or less. And the LEDs are limited to use within one year, while the LEDs is packed in moisture-proof package with the desiccants inside.

The package is opened:

The LEDs should be stored at 30°C or less and 60%RH or less. Moreover, the LEDs are limited to solder process within 72hrs. If the Humidity Indicator shows the pink color in 10% even higher or exceed the storage limiting time since opened, that we recommended to be with workable desiccants in original package.

Drive Method

An LED is a current-operated device. In order to ensure intensity uniformity on multiple LEDs connected in parallel in an application, it is recommended that a current limiting resistor be incorporated in the drive circuit, in series with each LED as shown in Circuit A below.

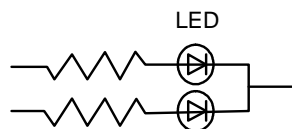

Circuit model A

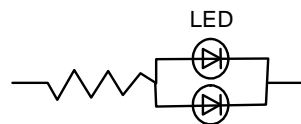

Circuit model B

(A) Recommended circuit.

(B) The brightness of each LED might appear different due to the differences in the I-V characteristics of those LEDs.

ESD (Electrostatic Discharge)

Static Electricity or power surge will damage the LED. Suggestions to prevent ESD damage:

- Use a conductive wrist band or anti-electrostatic glove when handling these LEDs.
- All devices, equipment, and machinery must be properly grounded.
- Work tables, storage racks, etc. should be properly grounded.
- Use ion blower to neutralize the static charge which might have built up on surface of the LED's plastic lens as a result of friction between LEDs during storage and handling.

ESD-damaged LEDs will exhibit abnormal characteristics such as high reverse leakage current, low forward voltage, or "no light up" at low currents. To verify for ESD damage, check for "light up" and V_F of the suspect LEDs at low currents. The V_F of "good" LEDs should be $>2.0V@0.1mA$ for InGaN product.

Suggested Checking List

Static-Safe Workstation & Work Areas

1. Static-safe working stations or work-areas have ESD signs.
2. All surfaces and objects at all static-safe workstation and within 1 ft measure less than 100V.
3. All ionizer activated, positioned towards the units.
4. Each work surface mats grounding is good.

Personnel Grounding

1. Every person (including visitors) handling ESD sensitive (ESDS) items wear wrist strap, heel strap or conductive shoes with conductive flooring.
2. If conductive footwear used, conductive flooring also present.
3. Garments, hairs or anything closer than 1 ft to ESD items measure less than 100V.
4. The wrist strap or heel strap/conductive shoes are checked daily and result recorded.
5. All wrist strap or heel strap checkers calibration up to date.

Device Handling

1. Each ESDS items identified by EIA-471 labels on item or packaging..
2. No static charge generators (e.g. plastics) inside shielding containers with ESDS items.
3. All flexible conductive and dissipative package materials are inspected before reuse or recycles