

# Pressure transmitter with flameproof enclosure

## For applications in explosion-protected areas

### Models E-10 and E-11

WIKA data sheet PE 81.27



for further approvals,  
see page 6

## Applications

- Borehole monitoring
- Refineries and petrochemical industry
- Drilling platforms and pipelines
- Gas compressors

## Special features

- CSA- and FM-approved as “explosionproof” for class I, div. 1 hazardous areas
- ATEX- and IECEx-approved as “flameproof enclosure” for II 2G Ex db IIC T6...T1 Gb
- Current or voltage output
- Designed for harsh ambient conditions
- Low-power version available as an option



**Fig. 1: Model E-10, ATEX, IECEx version**

**Fig. 2: Model E-11, FM, CSA version with potted cable leads**

## Description

The model E-10 and E-11 pressure transmitters with flameproof enclosure have been designed specifically for the high demands of industrial oil and gas applications.

These pressure transmitters are available with various analogue signals, from 4 ... 20 mA to battery-powered, low-power versions, e.g DC 1 ... 5 V.

They feature an exceptionally high resistance to vibration, pressure spikes and moisture ingress.

On each individual instrument a comprehensive quality control and calibration is performed, so that an accuracy of  $\leq 0.5\%$  can be ensured. Temperature compensation guarantees accuracy and long-term stability, even with strong fluctuations in the ambient temperature.

The models E-10 and E-11 are suitable for sour gas applications and feature particularly high resistance against sulphide stress cracking when in contact with sulphurous gases.

The pressure transmitters are approved as “explosionproof” for class I, II, III, div. 1 hazardous areas to FM and CSA as well as “flameproof” for II 2G Ex db IIC T6...T1 Gb to ATEX and IECEx.

## Specifications

Accuracy specifications	
Non-linearity per BFSL per IEC 61298-2	≤ 0.2 % of span
Accuracy	→ See "Max. measured error per IEC 61298-2"
Max. measured error per IEC 61298-2	0.5 % of span
Non-repeatability per IEC 61298-2	≤ 0.1 % of span
Mean temperature coefficient at 0 ... 80 °C [32 ... 176 °F]	
Zero point	≤ 0.2 % of span/10 K
Span	≤ 0.2 % of span/10 K
Long-term stability per DIN 16086	≤ 0.2 % of span/year For use in hydrogen applications, observe the technical information IN 00.40 at <a href="http://www.wika.com">www.wika.com</a> regarding long-term stability.
Reference conditions	Per IEC 61298-1

## Measuring ranges

Gauge pressure							
bar	Measuring range	0 ... 0.4	0 ... 0.6	0 ... 1	0 ... 1.6	0 ... 2.5	0 ... 4
	Overpressure limit	3.1	3.1	3.1	6.2	6.2	14
	Measuring range	0 ... 6	0 ... 10	0 ... 16	0 ... 25	0 ... 40	0 ... 60
	Overpressure limit	31	31	62	62	80	120
psi	Measuring range	0 ... 100	0 ... 160	0 ... 250	0 ... 400	0 ... 600 <sup>1) 3)</sup>	0 ... 1,000 <sup>2) 3)</sup>
	Overpressure limit	200	320	500	800	1,200	1,500
	Measuring range	0 ... 5	0 ... 10	0 ... 15	0 ... 25	0 ... 30	0 ... 60
	Overpressure limit	45	45	45	89	89	203
	Measuring range	0 ... 100	0 .. 160	0 ... 200	0 ... 250	0 ... 300	0 ... 500
	Overpressure limit	449	899	899	899	899	1,160
	Measuring range	0 ... 600	0 ... 750	0 ... 1,000	0 ... 1,500	0 ... 2,000	0 ... 3,000
	Overpressure limit	1,160	1,740	1,740	2,900	4,600	7,200
Measuring range	0 ... 5,000	0 ... 8,000 <sup>1) 3)</sup>	0 ... 10,000 <sup>2) 3)</sup>	0 ... 15,000 <sup>2) 3)</sup>			
Overpressure limit	11,600	17,400	17,400	21,750			

1) Measuring range not for model E-11 with FM and CSA approval

2) Measuring range not for model E-11

3) Measuring range not available for oxygen version, oil- and grease-free

Absolute pressure						
bar	Measuring range	0 ... 0.4	0 ... 0.6	0 ... 1	0 ... 1.6	0 ... 2.5
	Overpressure limit	2	4	5	10	10
	Measuring range	0 ... 4	0 ... 6	0 ... 10	0 ... 16	
psi	Overpressure limit	17	35	35	80	
	Measuring range	0 ... 15	0 ... 25	0 ... 30	0 ... 60	0 ... 100
	Overpressure limit	72	145	145	240	500

Vacuum and +/- measuring range						
bar	<b>Measuring range</b>	<b>-1 ... 0</b>	<b>-1 ... +0.6</b>	<b>-1 ... +1.5</b>	<b>-1 ... +3</b>	<b>-1 ... +5</b>
	Overpressure limit	2	4	5	10	17
	<b>Measuring range</b>	<b>-1 ... +9</b>	<b>-1 ... +15</b>	<b>-1 ... +25</b>		
	Overpressure limit	35	35	50		
psi	<b>Measuring range</b>	<b>-30 inHg ... 0</b>	<b>-30 inHg ... +30</b>	<b>-30 inHg ... +60</b>	<b>-30 inHg ... +100</b>	<b>-30 inHg ... +200</b>
	Overpressure limit	29	145	240	500	1,160
	<b>Measuring range</b>	<b>-30 inHg ... +300</b>				
	Overpressure limit	1,160				

Further details on: Measuring range	
<b>Units</b>	bar, psi, kg/cm <sup>2</sup> , MPa, kPa
<b>Overpressure limit</b>	→ See “measuring ranges”
<b>Vacuum resistance</b>	Yes

Process connection				
Standard	Thread size	Max. measuring range	Overpressure limit	Sealing
<b>Process connections for model E-10</b>				
EN 837	G ¼ B	1,000 bar [15,000 psi]	1,480 bar [21,400 psi]	-
	G ¼ female thread	1,000 bar [15,000 psi]	1,480 bar [21,400 psi]	-
	G ½ B	1,000 bar [15,000 psi]	1,480 bar [21,400 psi]	-
DIN EN ISO 1179-2 (formerly DIN 3852-E)	G ¼ A	600 bar [8,700 psi]	858 bar [12,440 psi]	NBR
ANSI/ASME B1.20.1	⅛ NPT	400 bar [5,800 psi]	572 bar [8,290 psi]	-
	¼ NPT	1,000 bar [15,000 psi]	1,480 bar [21,400 psi]	-
	¼ NPT female thread	1,000 bar [15,000 psi]	1,480 bar [21,400 psi]	-
	½ NPT	1,000 bar [15,000 psi]	1,480 bar [21,400 psi]	-
<b>Process connections for model E-11</b>				
-	G ½ B flush (available for measuring ranges 0 ... 2.5 to 0 ... 600 bar)	600 bar [8,700 psi]	600 bar [8,700 psi]	NBR
		400 bar [5,800 psi]	400 bar [5,800 psi]	FPM/FKM
		200 bar [2,900 psi]	200 bar [2,900 psi]	EPDM
-	G 1 B flush (available for measuring ranges 0 ... 0.4 to 0 ... 1.6 bar)	1.6 bar [20 psi]	10 bar [145 psi]	NBR
		1.6 bar [20 psi]	10 bar [145 psi]	FPM/FKM
		1.6 bar [20 psi]	10 bar [145 psi]	EPDM

Further details on: Process connection	
<b>Max. measuring range</b>	→ See above
<b>Overpressure limit</b>	→ See above
<b>Sealing</b>	→ See above
<b>Possible restrictions</b>	Depending on the choice of sealing on the process connection, there may be restrictions in the permissible medium and ambient temperature range.
NBR	-30 ... +100 °C [-22 ... +212 °F]
FPM/FKM	-15 ... +102 °C [5 ... 215 °F] / -15 ... +105 °C [5 ... 221 °F]

Output signal		
<b>Signal type</b>		
Current (2-wire)	4 ... 20 mA	
Voltage (3-wire)	<ul style="list-style-type: none"> <li>■ DC 0 ... 5 V</li> <li>■ DC 0.5 ... 4.5 V</li> <li>■ DC 1 ... 5 V</li> <li>■ DC 0 ... 10 V</li> </ul>	
<b>Load in <math>\Omega</math></b>		
Output signal 4 ... 20 mA	$\leq (\text{supply voltage} - 10 \text{ V}) / 0.02 \text{ A}$	
Output signal DC 0 ... 5 V	$> \text{maximum output signal} / 1 \text{ mA}$	
Output signal DC 0.5 ... 4.5 V	$> 100\text{k}$	
Output signal DC 1 ... 5 V	$> 100\text{k}$	
Output signal DC 0 ... 10 V	$> \text{maximum output signal} / 1 \text{ mA}$	
<b>Voltage supply</b>		
Supply voltage	Output signal 4 ... 20 mA	DC 10 ... 30 V
	Output signal DC 0 ... 5 V	DC 10 ... 30 V
	Output signal DC 0.5 ... 4.5 V	DC 5 ... 30 V
	Output signal DC 1 ... 5 V	DC 6 ... 30 V
	Output signal DC 0 ... 10 V	DC 14 ... 30 V
Power consumption	1 W	
<b>Dynamic behaviour</b>		
Settling time per IEC 61298-2	$\leq 2 \text{ ms}$	
	$\leq 10 \text{ ms}$	For model E-10 with measuring range $\leq 0 \dots 25 \text{ bar}$ at medium temperature $< -30 \text{ }^\circ\text{C}$ [ $-22 \text{ }^\circ\text{F}$ ]
		For model E-11

Electrical connection					
Connection type	IP code <sup>1) 2)</sup>	Wire cross-section	Cable diameter	Cable lengths	Cable material
½ NPT male conduit, with potted cable outlet (ATEX and IECEx approval)	IP67	3 x 0.5 mm <sup>2</sup> AWG20	6.8 mm [0.27 in]	<ul style="list-style-type: none"> <li>■ 2 m</li> <li>■ 5 m</li> <li>■ 10 m</li> </ul>	Polyolefin copolymer
½ NPT male conduit with cable outlet (FM and CSA approval)	NEMA 4x IP67	3 x 0.56 mm <sup>2</sup> AWG20	5.4 mm [0.21 in]	<ul style="list-style-type: none"> <li>■ 6 ft</li> <li>■ 10 ft</li> <li>■ 20 ft</li> <li>■ 30 ft</li> </ul>	PVC
½ NPT male conduit, with potted cable leads (FM and CSA approval)	NEMA 4x IP67	3 x 0.5 mm <sup>2</sup> AWG20	3 x 2.6 mm [3 x 0.10 in]	<ul style="list-style-type: none"> <li>■ 6 ft</li> <li>■ 10 ft</li> <li>■ 20 ft</li> <li>■ 30 ft</li> </ul>	Polyolefin

1) The stated IP codes only apply when plugged in using mating connectors that have the appropriate IP code.

2) For IP code IP67 the ambient temperature range is limited to  $-40 \text{ }^\circ\text{C} \dots +80 \text{ }^\circ\text{C}$  [ $-40 \text{ }^\circ\text{F} \dots +176 \text{ }^\circ\text{F}$ ].

Further details on: Electrical connection	
Connection type	→ See above
Wire cross-section	→ See above
Cable diameter	→ See above
Cable lengths	→ See above
Pin assignment	→ See below
Ingress protection (IP code) per IEC 60529	→ See above
Short-circuit resistance	S <sub>+</sub> vs. U-
Reverse polarity protection	U <sub>+</sub> vs. U-
Insulation voltage	DC 500 V

## Pin assignment

### ½ NPT male conduit, with potted cable outlet (ATEX and IECEx approval)

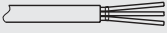
		2-wire	3-wire
	U+	Red	Red
	U-	Black	Black
	S+	-	Brown
	Shield	Shield connected to case	

### ½ NPT male conduit, with potted cable leads (FM and CSA approval)

		2-wire	3-wire
	U+	Red	Red
	U-	Black	Black
	S+	-	Brown
	Shield	Green	Green

### ½ NPT male conduit, with cable outlet (FM and CSA approval)

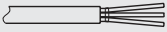
		2-wire	3-wire
	U+	Red	Red
	U-	Black	Black
	S+	-	Brown
	Shield	Shield connected to case	

## Legend

- U+ Positive power supply terminal
- U- Negative power supply terminal
- S+ Analogue output

## Material

### Material (wetted)

Model E-11 and E-10 with measuring range ≤ 25 bar	Stainless steel
Model E-10 with measuring range > 25 bar, NACE-compliant	■ Stainless steel ■ Elgiloy®
Sealing	→ See "Process connection"

### Material (in contact with the environment)

Case	Stainless steel
Cable	→ See "Electrical connection"

### Pressure transmission medium

Model E-11 and E-10 with measuring range ≤ 25 bar	Synthetic oil
Model E-10 with measuring range > 25 bar	No pressure transmission medium



Operating conditions			
<b>Permissible temperature ranges</b> <sup>1) 2) 3) 4)</sup>			
Instruments per ATEX and IECEx	Medium and ambient temperature limit	T6	-40 ... +60 °C [-40 ... +140 °F]
		T5	-40 ... +75 °C [-40 ... +167 °F]
		T4 ... T1	-40 ... +105 °C [-40 ... +221 °F]
	Storage temperature limit	-40 ... +70 °C [-40 ... +158 °F]	
Instruments per FM, CSA	Medium and ambient temperature limit	T6	-40 ... +60 °C [-40 ... +140 °F]
		T4 ... T1	-40 ... +105 °C [-40 ... +221 °F]
			Storage temperature limit
<b>Vibration resistance per IEC 60068-2-6</b>	10 g		
<b>Shock resistance per IEC 60068-2-27</b>	100 g (mechanical shock)		
<b>Ingress protection (IP code) per IEC 60529</b> <sup>4)</sup>	→ See "Electrical connection"		



- 1) Restricted medium temperature range for oxygen applications: -20 ... +60 °C [-4 ... +140 °F]  
2) For restrictions, see "Further details on: Process connection"  
3) Restriction for version with protective cap: T4 ... T1, -40 ... +102 °C [-40 ... +215 °F]  
4) For IP code IP67 the ambient temperature range is limited to -40 °C ... +80 °C [-40 ... +176 °F]

Options for specific media		
<b>Oil- and grease-free</b>		
Residual hydrocarbon	< 1,000 mg/m <sup>2</sup>	
Packaging	Protection cap on the process connection	
<b>Oxygen, oil- and grease-free</b>		
Measuring ranges	Max. 400 bar [5,000 psi]	
Over pressure limit	2 times	
Residual hydrocarbon	Measuring ranges < 30 bar [435 psi]	< 500 mg/m <sup>2</sup>
	Measuring ranges > 30 bar [435 psi]	< 200 mg/m <sup>2</sup>
Packaging	Protection cap on the process connection	
Max. permissible temperature range	-20 ... +60 °C [-4 ... +140 °F]	
Elastomer sealing	Max. -15 ... +60 °C [5 ... 140 °F] and max. 30 bar [435 psi] measuring range	
<b>Hydrogen</b>	On request	



Packaging and instrument labelling	
<b>Packaging</b>	Individual packaging
<b>Instrument labelling</b>	WIKA product label, glued

## Approvals

Logo	Description	Country
	<b>EU declaration of conformity</b>	European Union
	EMC directive	
	EN 61326 emission (group 1, class B) and immunity (industrial environments)	
	Pressure equipment directive	
	ATEX directive	International
	Flameproof enclosure (Ex d), EN 60079-0, EN 60079-1	
	<b>IECEx</b> Hazardous areas Flameproof enclosure (Ex d), IEC 60079-0, IEC 60079-1	International

Logo	Description	Country
	<b>FM</b> Hazardous areas Explosionproof class 3600, class 3615, class 3810	USA
	<b>CSA</b> <ul style="list-style-type: none"> <li>■ Safety (e.g. electr. safety, overpressure, ...)</li> <li>■ Hazardous areas</li> </ul> Class 2258 02, class 2258 82	USA and Canada

### Optional approvals

Logo	Description	Country
	<b>EAC</b>	Eurasian Economic Community
	Electromagnetic compatibility Hazardous areas	
	<b>KCs</b> Hazardous areas	Korea
-	<b>CRN</b> Safety (e.g. electr. safety, overpressure, ...)	Canada

→ Approvals and certificates, see website

### Manufacturer's information

Logo	Description
-	China RoHS directive

### Safety-related characteristic values

Safety-related characteristic values	
<b>MTTF</b>	> 100 years

→ Approvals and certificates, see website

Safety-related characteristic values (Ex)	
<b>Ex marking</b>	
ATEX and IECEx	II 2G Ex db IIC T6...T1 Gb (KEMA 05 ATEX 2240 X) Ex db IIC T6...T1 Gb (IECEx DEK 15.0048X)
FM	Explosionproof for Class I, Division 1, Groups A, B, C and D Class II, Division 1, Groups E, F and G Class III, Division 1 Type 4
CSA	Explosionproof for Class I, Division 1, Groups A, B, C and D Class II, Division 1, Groups E, F and G Class III, Division 1 Type 4X

## Dimensions in mm [in]

½ NPT male conduit, with potted cable outlet  
(ATEX and IECEx approval)  
Model E-1\*-\*\*\*-\*\*\*DX\*\*\* (without protective cap)

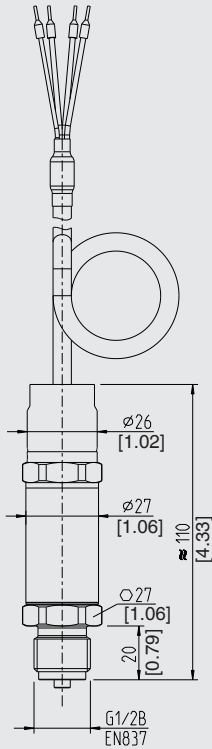

½ NPT male conduit, with potted cable outlet  
(ATEX and IECEx approval)  
Model E-1\*-\*\*\*-\*\*\*CX\*\*\* (without protective cap)

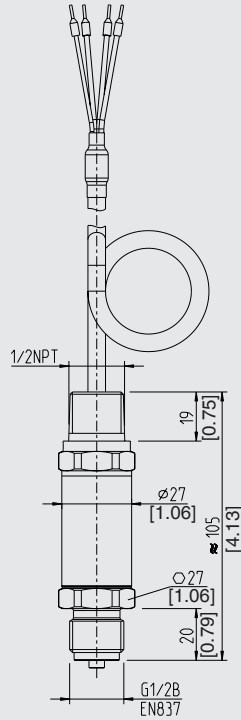

½ NPT male conduit, with cable outlet  
(FM and CSA approval)  
Model E-1\*-\*\*\*-\*\*\*2X\*\*

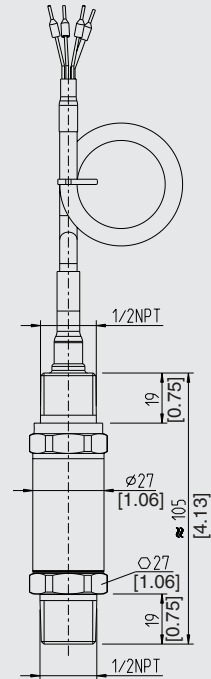

½ NPT male conduit, with potted cable leads  
(FM and CSA approval)  
Model E-1\*-\*\*\*-\*\*\*3X\*\*

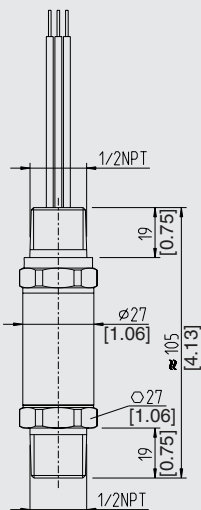



## Process connections model E-10

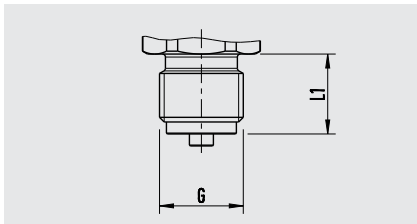

G	L1
G ¼ B EN 837	13 [0.51]
G ½ B EN 837	20 [0.79]

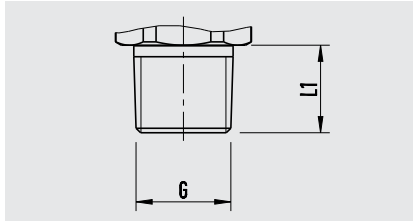

G	L1
⅛ NPT ANSI/ASME B1.20.1	10 [0.39]
¼ NPT ANSI/ASME B1.20.1	13 [0.51]
½ NPT ANSI/ASME B1.20.1	19 [0.75]

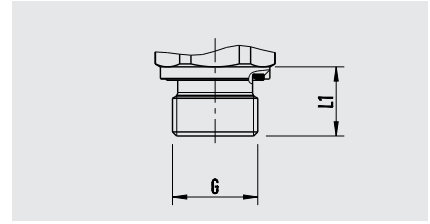

G	L1
G ¼ A DIN EN ISO 1179-2	14 [0.55]

EN 837, female thread

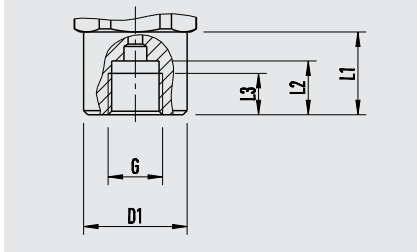

G	L1	L2	L3	D1
G ¼	19.5 [0.77]	13 [0.51]	10 [0.39]	Ø17.5 [0.69]

ANSI/ASME B1.20.1, female thread

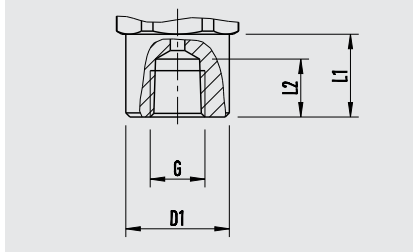

G	L1	L2	D1
¼ NPT	20 [0.79]	14 [0.55]	Ø 26.5 [1.04]

## Process connections model E-11

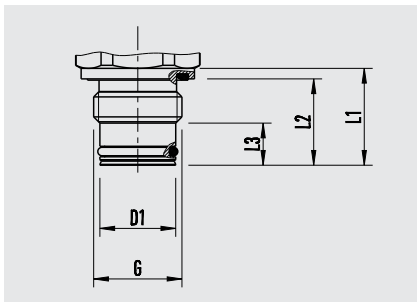

G	L1	L2	L3	D1
G ½ B	23 [0.9]	20.5 [0.81]	10 [0.39]	Ø 18 [0.71]

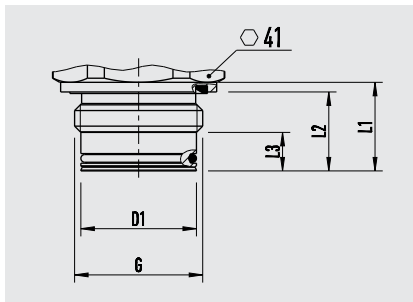

G1	L1	L2	L3	D1
G 1 B	23 [0.9]	20.5 [0.81]	10 [0.39]	30 [1.18]

→ For information on tapped holes and welding sockets, see Technical information IN 00.14 at [www.wika.com](http://www.wika.com)

### Ordering information

Model / Measuring range / Output signal / Electrical connection / Process connection / Sealing

© 01/2006 WIKA Alexander Wiegand SE & Co. KG, all rights reserved.  
The specifications given in this document represent the state of engineering at the time of publishing.  
We reserve the right to make modifications to the specifications and materials.

