

# REF62xx High-Precision Voltage Reference With Integrated ADC Drive Buffer

## 1 Features

- Excellent Temperature Drift Performance
  - 3 ppm/°C (max) from 0°C to +70°C
- Extremely Low Noise
  - Total Noise: 5  $\mu\text{V}_{\text{RMS}}$  With 47- $\mu\text{F}$  Capacitor
  - 1/f Noise (0.1 Hz to 10 Hz): 3  $\mu\text{V}_{\text{PP/V}}$
- Integrated ADC Drive Buffer
  - Low Output Impedance: < 50 m $\Omega$  (0-200 kHz)
  - First Sample Precise to 18 Bits With [ADS8881](#)
  - Enables Burst-Mode DAQ Systems
- Low Supply Current: 820  $\mu\text{A}$
- Low Shutdown Current: 1  $\mu\text{A}$
- High Initial Accuracy:  $\pm 0.05\%$
- Very-Low Noise and Distortion
  - SNR: 100.5 dB, THD: –125 dB ([ADS8881](#))
  - SNR: 106 dB, THD: –120 dB ([ADS127L01](#))
- Output Current Drive:  $\pm 4$  mA
- Programmable Short-Circuit Current
- Verified to Drive REF Pin of [ADS88xx family](#) of SAR ADCs and [ADS127xx family](#) of Wideband  $\Delta\Sigma$  ADCs

## 2 Applications

- ATE Testers and Oscilloscopes
- Test and Measurement Equipment
- Analog Input Modules for PLCs
- Medical Equipment
- Precision Data Acquisition Systems

## 3 Description

The voltage references in the REF6000 family have an integrated low output impedance buffer that enables the user to directly drive the reference (REF) pin of precision data converters, while preserving linearity, distortion, and noise performance. Most precision SAR and delta-sigma analog-to-digital converters (ADCs), switch binary-weighted capacitors onto the REF pin during the conversion process. In order to support this dynamic load, the output of the voltage reference must be buffered with a low-output impedance, high-bandwidth buffer. The REF6000 family devices are well suited, but not limited, to drive the REF pin of the [ADS88xx family](#) of SAR ADCs, and [ADS127xx family](#) of delta-sigma ADCs, as well as precision digital-to-analog converters (DACs).

The REF6000 family of is able to maintain an output voltage within 1LSB (18-bit) with minimal droop, even during the first conversion while driving the REF pin of the ADS8881. This feature is useful in burst-mode, event-triggered, equivalent-time sampling, and variable-sampling-rate data-acquisition systems. The REF62xx variants of REF6000 family specify a maximum temperature drift of just 3 ppm/°C and initial accuracy of 0.05% for both the voltage reference and the low output impedance buffer combined. For various temperature drift options in REF6000 family, see the [Device Comparison Table](#).

### Device Information<sup>(1)</sup>

PART NUMBER	PACKAGE	BODY SIZE (NOM)
REF62xx	VSSOP (8)	3.00 mm x 3.00 mm

(1) For all available packages, see the package option addendum at the end of the data sheet.

### Typical Application

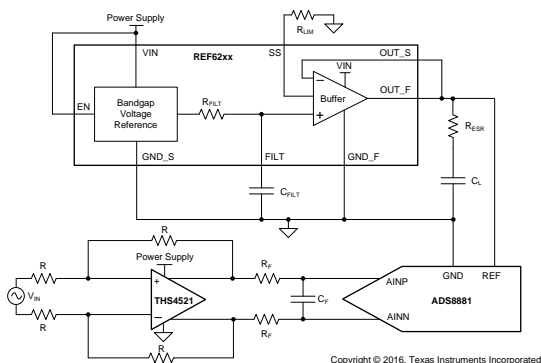

### Reference Droop comparison (1 LSB = 19.07 $\mu\text{V}$ , With ADS8881 at 1 MSPS)

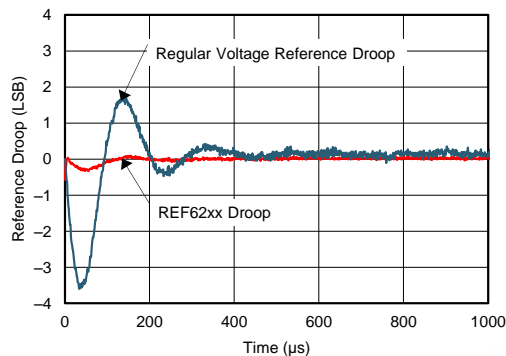

## Table of Contents

<b>1 Features</b> .....	<b>1</b>	9.2 Functional Block Diagram .....	<b>19</b>
<b>2 Applications</b> .....	<b>1</b>	9.3 Feature Description .....	<b>20</b>
<b>3 Description</b> .....	<b>1</b>	9.4 Device Functional Modes .....	<b>23</b>
<b>4 Revision History</b> .....	<b>2</b>	<b>10 Applications and Implementation</b> .....	<b>24</b>
<b>5 Device Comparison Table</b> .....	<b>3</b>	10.1 Application Information .....	<b>24</b>
<b>6 Pin Configuration and Functions</b> .....	<b>3</b>	10.2 Typical Application .....	<b>24</b>
<b>7 Specifications</b> .....	<b>4</b>	<b>11 Power Supply Recommendations</b> .....	<b>27</b>
7.1 Absolute Maximum Ratings .....	<b>4</b>	<b>12 Layout</b> .....	<b>28</b>
7.2 ESD Ratings .....	<b>4</b>	12.1 Layout Guidelines .....	<b>28</b>
7.3 Recommended Operating Conditions .....	<b>4</b>	12.2 Layout Example .....	<b>28</b>
7.4 Thermal Information .....	<b>4</b>	<b>13 Device and Documentation Support</b> .....	<b>29</b>
7.5 Electrical Characteristics .....	<b>5</b>	13.1 Documentation Support .....	<b>29</b>
7.6 Typical Characteristics .....	<b>7</b>	13.2 Related Links .....	<b>29</b>
<b>8 Parameter Measurement Information</b> .....	<b>14</b>	13.3 Receiving Notification of Documentation Updates .....	<b>29</b>
8.1 Solder Heat Shift .....	<b>14</b>	13.4 Community Resources .....	<b>29</b>
8.2 Thermal Hysteresis .....	<b>15</b>	13.5 Trademarks .....	<b>29</b>
8.3 Reference Droop Measurements .....	<b>16</b>	13.6 Electrostatic Discharge Caution .....	<b>29</b>
8.4 1/f Noise Performance .....	<b>18</b>	13.7 Glossary .....	<b>30</b>
<b>9 Detailed Description</b> .....	<b>19</b>	<b>14 Mechanical, Packaging, and Orderable Information</b> .....	<b>30</b>
9.1 Overview .....	<b>19</b>		

## 4 Revision History

DATE	REVISION	NOTES
September 2016	*	Initial release.

## 5 Device Comparison Table

DEVICE FAMILY	TEMPERATURE DRIFT
REF60xx	5 ppm/°C from –40 to 125°C
REF61xx	8 ppm/°C from –40 to 125°C
REF62xx	3 ppm/°C from 0 to 70°C

## 6 Pin Configuration and Functions

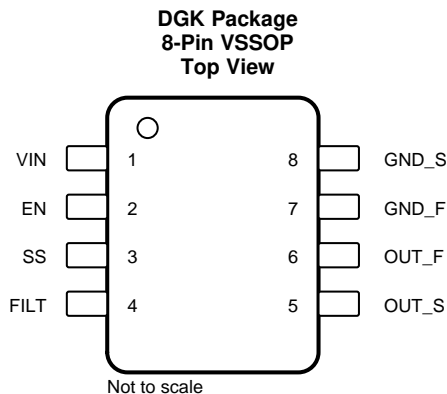

### Pin Functions

PIN		TYPE	DESCRIPTION
NAME	NO.		
EN	2	Input	Enable pin
FILT	4	—	Filter capacitor pin. A capacitor ( $C_{FILT} \geq 1 \mu F$ ) must be connected between the FILT pin and ground for stability.
GND_F	7	Ground	Ground force pin
GND_S	8	Ground	Ground sense pin
OUT_F	6	Output	Output voltage force pin
OUT_S	5	Input	Output voltage sense pin
SS	3	—	Short circuit current limit pin. Connect a resistor to this pin to set the output short-circuit current limit. Connect to VIN pin for highest current limit
VIN	1	Power	Input supply voltage pin

## 7 Specifications

### 7.1 Absolute Maximum Ratings<sup>(1)</sup>

over operating free-air temperature range (unless otherwise noted)

		MIN	MAX	UNIT
Input voltage	V <sub>IN</sub>	-0.3	6	V
	V <sub>EN</sub>	-0.3	V <sub>IN</sub> + 0.3	V
Operating temperature, T <sub>A</sub>		-55	150	°C
Junction temperature, T <sub>J</sub>			150	°C
Storage temperature, T <sub>stg</sub>		-65	150	°C

- (1) Stresses beyond those listed under *Absolute Maximum Ratings* may cause permanent damage to the device. These are stress ratings only, which do not imply functional operation of the device at these or any other conditions beyond those indicated under *Recommended Operating Conditions*. Exposure to absolute-maximum-rated conditions for extended periods may affect device reliability.

### 7.2 ESD Ratings

		VALUE	UNIT
V <sub>(ESD)</sub> Electrostatic discharge	Human-body model (HBM), per ANSI/ESDA/JEDEC JS-001 <sup>(1)</sup>	±1000	V
	Charged-device model (CDM), per JEDEC specification JESD22-C101 <sup>(2)</sup>	±250	

- (1) JEDEC document JEP155 states that 500-V HBM allows safe manufacturing with a standard ESD control process.

- (2) JEDEC document JEP157 states that 250-V CDM allows safe manufacturing with a standard ESD control process.

### 7.3 Recommended Operating Conditions

		MIN	NOM	MAX	UNIT
V <sub>IN</sub> Supply input voltage (I <sub>OUT</sub> = 0 mA)	REF6225	3		5.5	V
	REF6230, REF6233, REF6241, REF6245	V <sub>OUT</sub> + 0.25		5.5	
	REF6250	5.3		5.5	
V <sub>EN</sub> Enable voltage		0		V <sub>IN</sub>	V
I <sub>L</sub> Output current	REF6225, REF6230, REF6233, REF6241	-4		4	mA
	REF6245	-3.5		3.5	
	REF6250	-3		3	
T <sub>A</sub> Operating temperature		0	25	70	°C

### 7.4 Thermal Information

THERMAL METRIC <sup>(1)</sup>		REF62xx	UNIT
		DGK (VSSOP)	
		8 PINS	
R <sub>θJA</sub>	Junction-to-ambient thermal resistance	158.5	°C/W
R <sub>θJC(top)</sub>	Junction-to-case (top) thermal resistance	51.2	°C/W
R <sub>θJB</sub>	Junction-to-board thermal resistance	79.5	°C/W
ψ <sub>JT</sub>	Junction-to-top characterization parameter	5.2	°C/W
ψ <sub>JB</sub>	Junction-to-board characterization parameter	78.0	°C/W
R <sub>θJC(bot)</sub>	Junction-to-case (bottom) thermal resistance	N/A	°C/W

- (1) For more information about traditional and new thermal metrics, see the [Semiconductor and IC Package Thermal Metrics](#) application report.

## 7.5 Electrical Characteristics

at  $T_A = 25^\circ\text{C}$ ,  $V_{IN} = 5\text{ V}$  for all devices except REF6250,  $V_{IN} = 5.4\text{ V}$  for REF6250,  $I_L = 0\text{ mA}$ ,  $C_L = 22\text{ }\mu\text{F}$ ,  $C_{FILT} = 1\text{ }\mu\text{F}$ , and  $V_{EN} = 5\text{ V}$  (unless otherwise noted)

PARAMETER		TEST CONDITIONS		MIN	TYP	MAX	UNIT
<b>ACCURACY AND DRIFT</b>							
Output voltage accuracy				-0.05%		0.05%	
Output voltage temperature coefficient <sup>(1)</sup>						3	ppm/°C
<b>LINE AND LOAD REGULATION</b>							
$\Delta V_{O(\Delta V)}$ Line regulation	REF6225	$V_{OUT} + 0.5\text{ V} \leq V_{IN} \leq 5.5\text{ V}$	$T_A = 25^\circ\text{C}$	4	20	ppm/V	
			$T_A = 0^\circ\text{C to } +70^\circ\text{C}$		30		
	REF6230, REF6233, REF6241, REF6245	$V_{OUT} + 0.25\text{ V} \leq V_{IN} \leq 5.5\text{ V}$	$T_A = 25^\circ\text{C}$	4	20		
			$T_A = 0^\circ\text{C to } +70^\circ\text{C}$		30		
	REF6250	$V_{OUT} + 0.3\text{ V} \leq V_{IN} \leq 5.5\text{ V}$	$T_A = 25^\circ\text{C}$	7	60		
			$T_A = 0^\circ\text{C to } +70^\circ\text{C}$		120		
$\Delta V_{O(\Delta I)}$ Load regulation, sourcing and sinking	REF6225, REF6230, REF6233, REF6241	$I_L = 0\text{ mA to } 4\text{ mA}$ , $V_{IN} = V_{OUT} + 600\text{ mV}$	$T_A = 25^\circ\text{C}$	2	20	ppm/mA	
			$T_A = 0^\circ\text{C to } +70^\circ\text{C}$		30		
	REF6245	$I_L = 0\text{ mA to } 3.5\text{ mA}$ , $V_{IN} = V_{OUT} + 600\text{ mV}$	$T_A = 25^\circ\text{C}$	2	20		
			$T_A = 0^\circ\text{C to } +70^\circ\text{C}$		30		
	REF6250	$I_L = 0\text{ mA to } 3\text{ mA}$ , $V_{IN} = V_{OUT} + 400\text{ mV}$	$T_A = 25^\circ\text{C}$	2	20		
			$T_A = 0^\circ\text{C to } +70^\circ\text{C}$		50		
$I_{SC}$ Short-circuit current	SS = open			10.5		mA	
<b>NOISE</b>							
Total integrated noise	$C_L = 22\text{ }\mu\text{F}$			5		$\mu\text{V}_{RMS}$	
	$C_L = 47\text{ }\mu\text{F}$			5			
Low frequency noise	$0.1\text{ Hz} \leq f \leq 10\text{ Hz}$			3		$\mu\text{V}_{PP}/\text{V}$	
<b>OUTPUT IMPEDANCE</b>							
Output impedance	$f = \text{DC to } 200\text{ kHz}$ , $C_L = 47\text{ }\mu\text{F}$			50		m $\Omega$	
<b>TURN-ON TIME</b>							
$t_{on}$ Turn-on time	0.1% settling, $C_L = 47\text{ }\mu\text{F}$ , SS = open, REF6225			100		ms	
<b>HYSTERESIS AND LONG TERM DRIFT</b>							
Long term stability	0 to 1000h at $25^\circ\text{C}$			80		ppm	
	1000h to 2000h at $25^\circ\text{C}$			20			
Output voltage hysteresis <sup>(2)</sup>	25°C, 0°C, 70°C, 25°C (cycle 1)			33		ppm	
	25°C, 0°C, 70°C, 25°C (cycle 2)			8			
<b>CAPACITIVE LOAD</b>							
$C_L$ Stable output capacitor value				10	47	$\mu\text{F}$	

(1) Temperature drift is specified according to the box method. See the [Feature Description](#) section for more details.

(2) See the [Thermal Hysteresis](#) section.

**Electrical Characteristics (continued)**

 at  $T_A = 25^\circ\text{C}$ ,  $V_{IN} = 5\text{ V}$  for all devices except REF6250,  $V_{IN} = 5.4\text{ V}$  for REF6250,  $I_L = 0\text{ mA}$ ,  $C_L = 22\text{ }\mu\text{F}$ ,  $C_{FILT} = 1\text{ }\mu\text{F}$ , and  $V_{EN} = 5\text{ V}$  (unless otherwise noted)

PARAMETER		TEST CONDITIONS		MIN	TYP	MAX	UNIT
<b>OUTPUT VOLTAGE</b>							
$V_{OUT}$	Output voltage	REF6225		2.5		V	
		REF6230		3			
		REF6233		3.3			
		REF6241		4.096			
		REF6245		4.5			
		REF6250		5			
<b>POWER SUPPLY</b>							
$I_{CC}$	Supply current	REF6225, REF6230, REF6233, REF6241	Active mode, $V_{EN} = 5\text{ V}$	$T_A = 25^\circ\text{C}$	0.82	0.90	mA
				$T_A = -40^\circ\text{C to } +125^\circ\text{C}$	1.1		
		REF6245, REF6250	Active mode, $V_{EN} = 5\text{ V}$	$T_A = 25^\circ\text{C}$	0.83	0.95	
				$T_A = -40^\circ\text{C to } +125^\circ\text{C}$	1.15		
		Shutdown mode, $V_{EN} = 0\text{ V}$		$T_A = 25^\circ\text{C}$	1	3	$\mu\text{A}$
				$T_A = -40^\circ\text{C to } +125^\circ\text{C}$	15		
Enable pin voltage	Voltage reference in active mode ( $EN = 1$ )			1.6		V	
	Voltage reference in shutdown mode ( $EN = 0$ )			0.6			
Enable pin current	$V_{EN} = 5\text{ V}$			100	150	nA	
Dropout voltage	REF6225	$I_L = 0\text{ mA}$		500	500	mV	
		$I_L = 4\text{ mA}$		600			
	REF6230, REF6233, REF6241	$I_L = 0\text{ mA}$		50	250		
		$I_L = 4\text{ mA}$		600			
	REF6245	$I_L = 0\text{ mA}$		50	250		
		$I_L = 3.5\text{ mA}$		600			
	REF6250	$I_L = 0\text{ mA}$		100	300		
		$I_L = 3\text{ mA}$		400			

## 7.6 Typical Characteristics

at  $T_A = 25^\circ\text{C}$ ,  $I_L = 0\text{ mA}$ , and  $V_{IN} = 5\text{ V}$ , using REF6225 (unless otherwise noted)

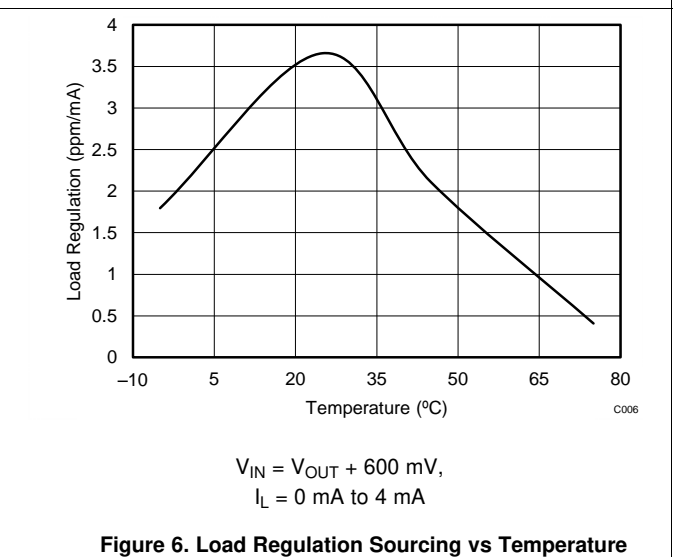
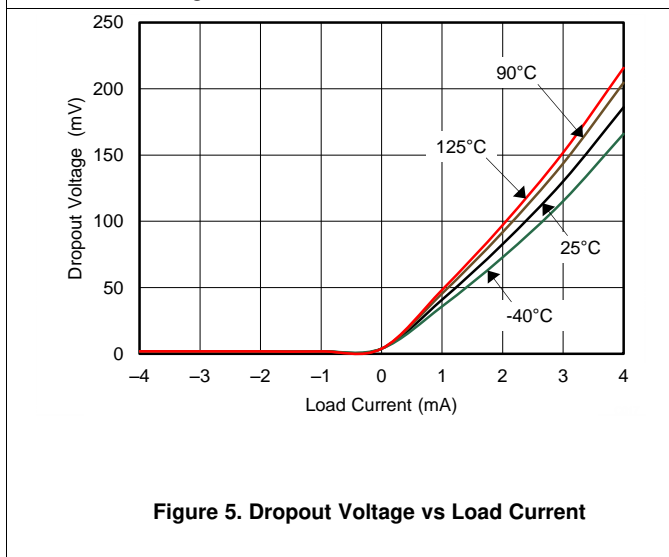
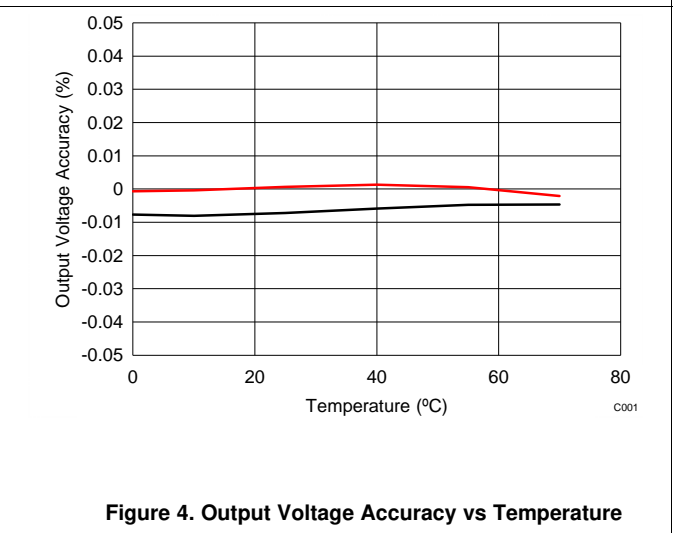
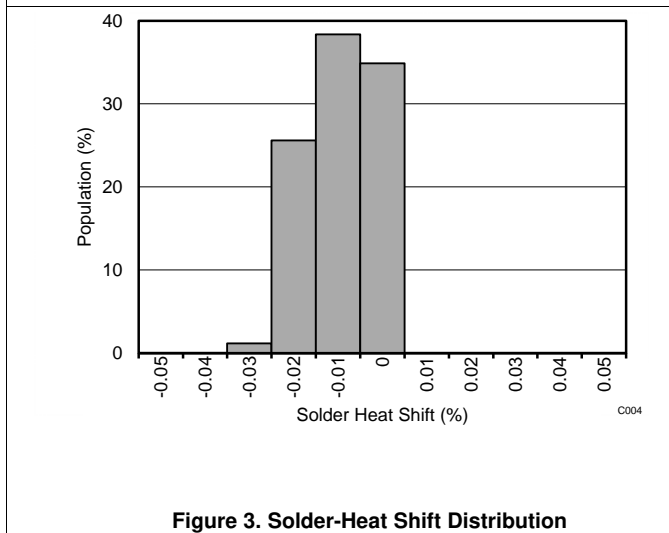
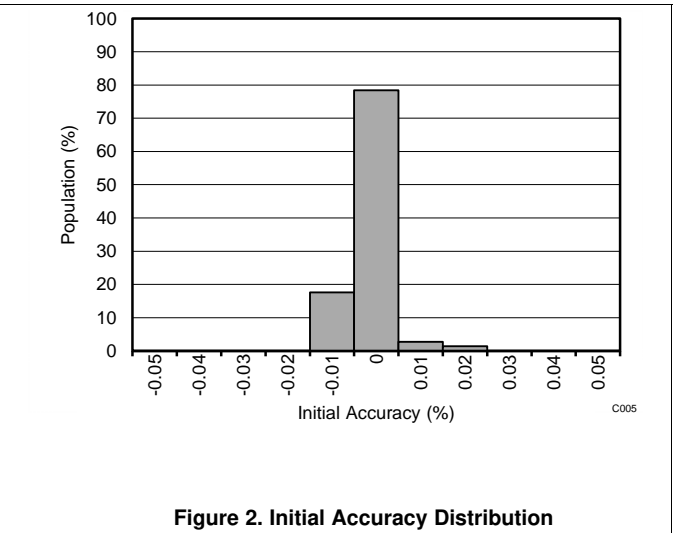
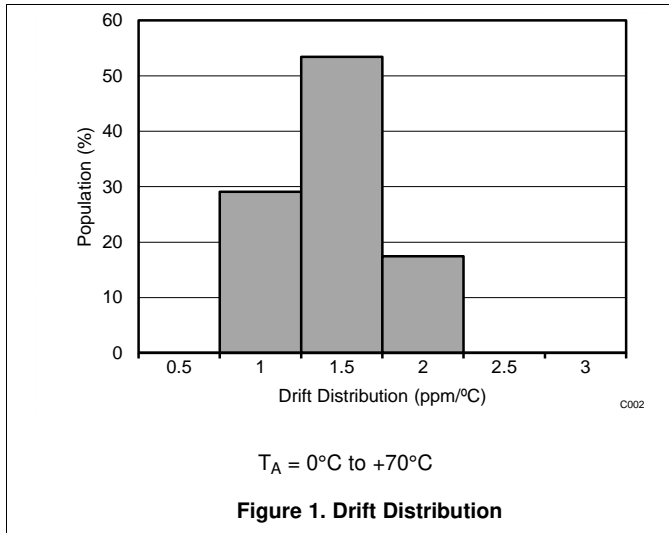

Typical Characteristics (continued)

at  $T_A = 25^\circ\text{C}$ ,  $I_L = 0\text{ mA}$ , and  $V_{IN} = 5\text{ V}$ , using REF6225 (unless otherwise noted)

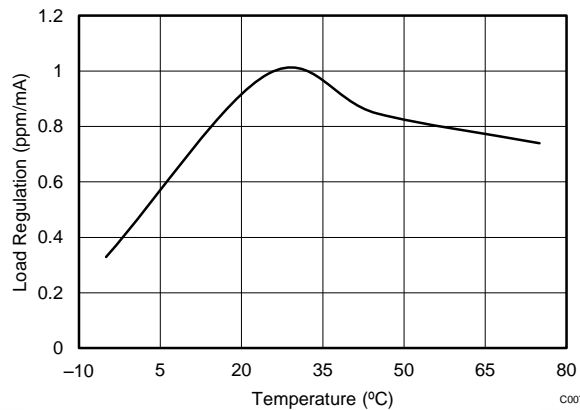

$$V_{IN} = V_{OUT} + 600\text{ mV},$$

$$I_L = 0\text{ mA to } 4\text{ mA}$$

Figure 7. Load Regulation Sinking vs Temperature

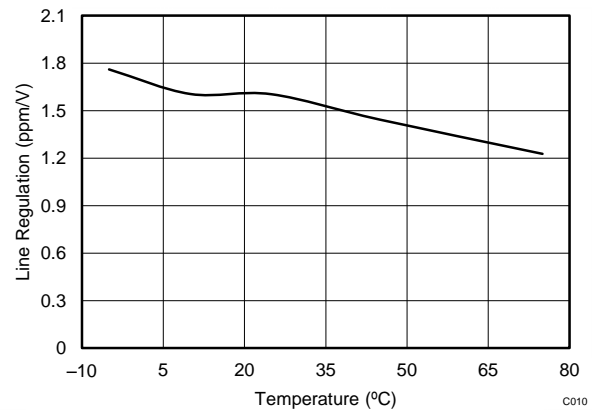

$$V_{OUT} + 0.25\text{ V} \leq V_{IN} \leq 5.5\text{ V}$$

Figure 8. Line Regulation vs Temperature

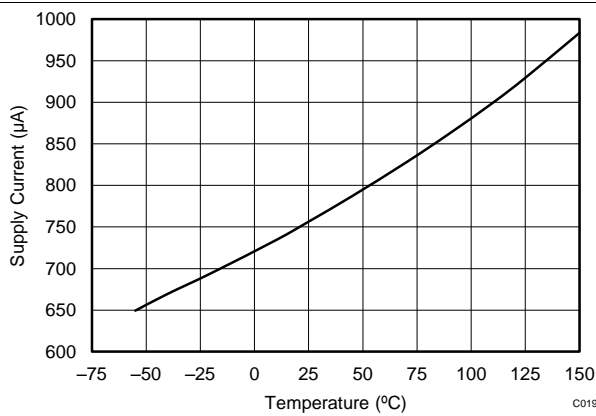

Figure 9. Supply Current vs Temperature

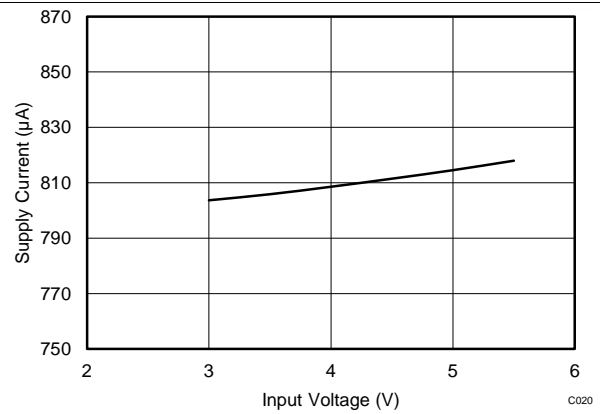

Figure 10. Supply Current vs Input Voltage

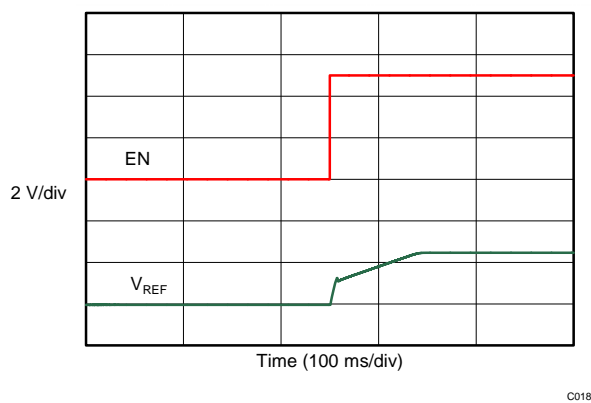

Figure 11. Turn-On Settling Time

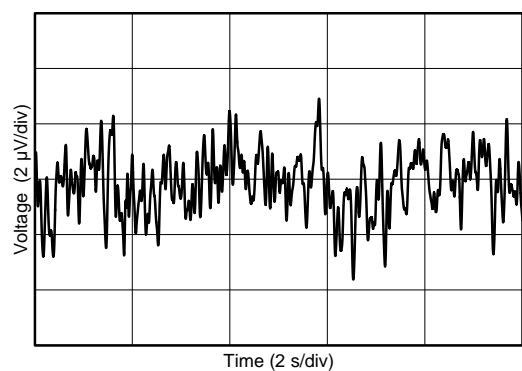

Figure 12. 0.1-Hz to 10-Hz Noise



Typical Characteristics (continued)

at  $T_A = 25^\circ\text{C}$ ,  $I_L = 0 \text{ mA}$ , and  $V_{IN} = 5 \text{ V}$ , using REF6225 (unless otherwise noted)

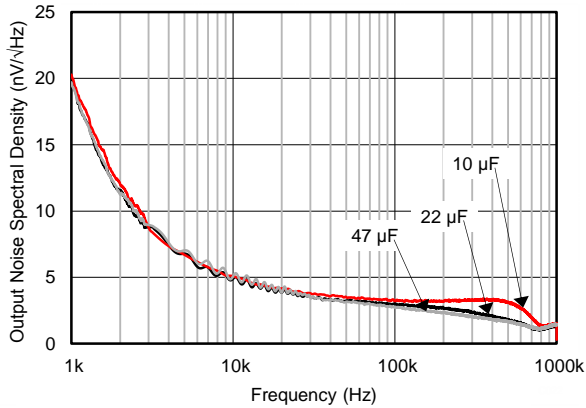

Figure 13. Output-Voltage Noise Spectrum

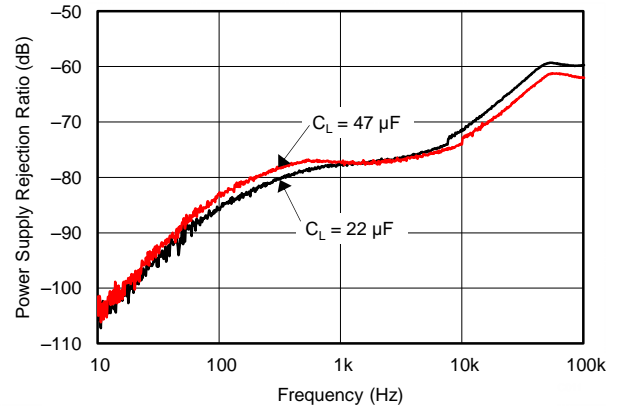
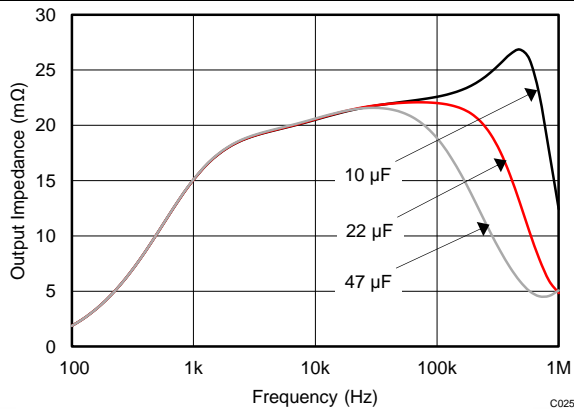
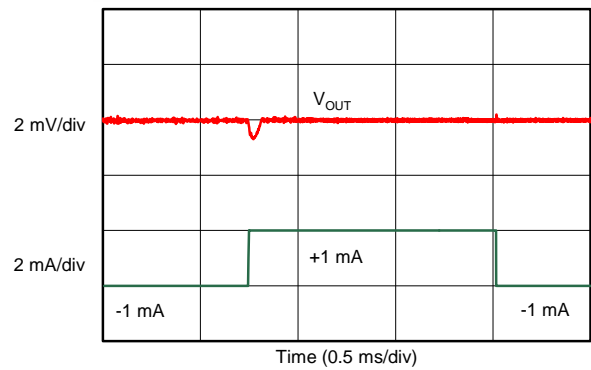

Figure 14. PSRR vs Frequency



Graph obtained by design simulation

Figure 15. Output Impedance vs Frequency



Load current =  $\pm 1 \text{ mA}$

Figure 16. Load Transient Response

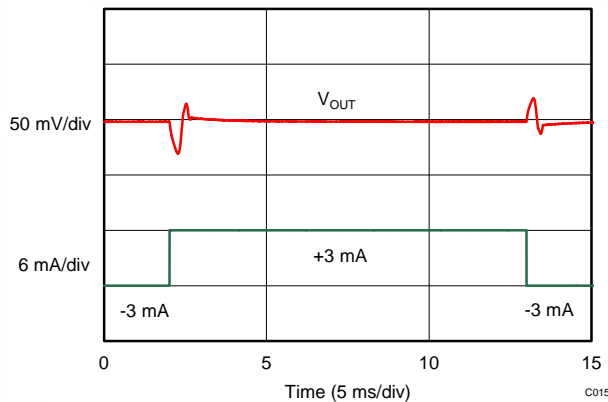

Load current =  $\pm 3 \text{ mA}$

Figure 17. Load Transient Response

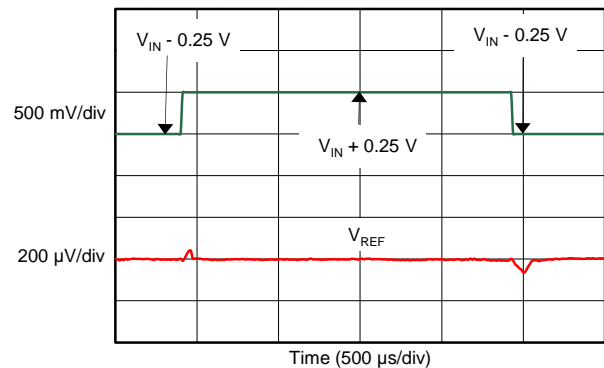

Figure 18. Line Transient Response

### Typical Characteristics (continued)

at  $T_A = 25^\circ\text{C}$ ,  $I_L = 0\text{ mA}$ , and  $V_{IN} = 5\text{ V}$ , using REF6225 (unless otherwise noted)

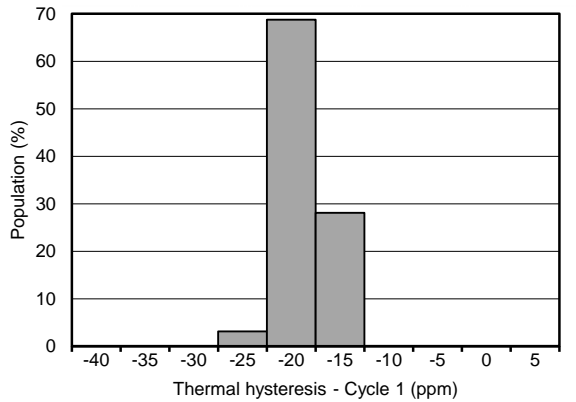

Figure 19. Thermal Hysteresis Distribution (Cycle 1)

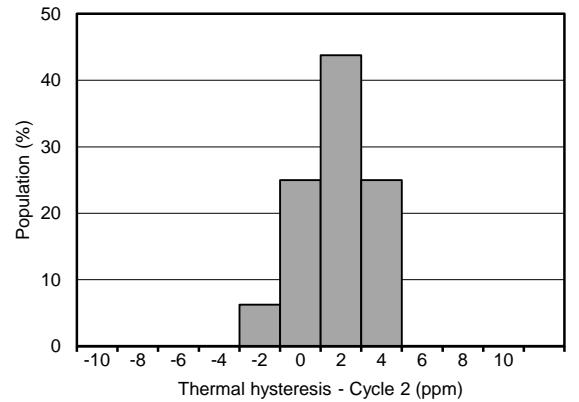

Figure 20. Thermal Hysteresis Distribution (Cycle 2)

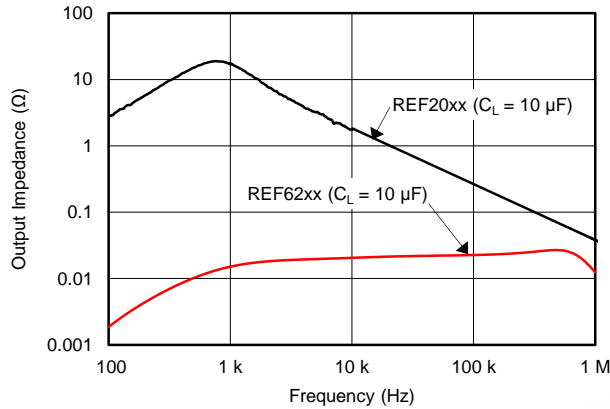

Figure 21. Output Impedance Comparison

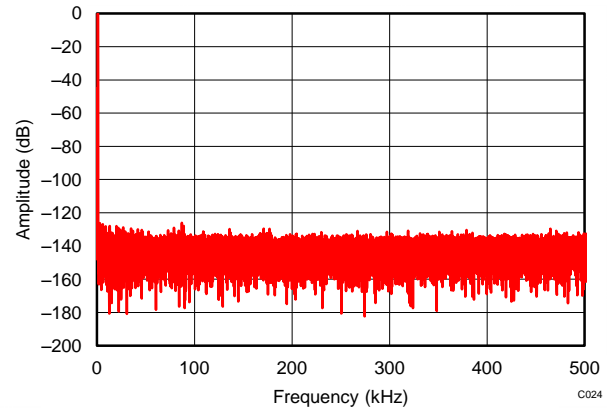

Figure 22. Typical FFT Plot

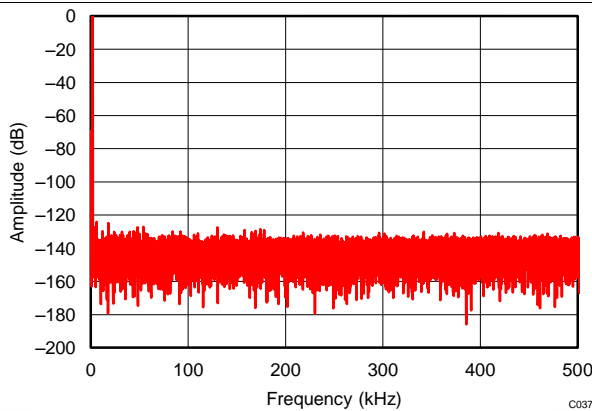

Figure 23. Typical FFT Plot

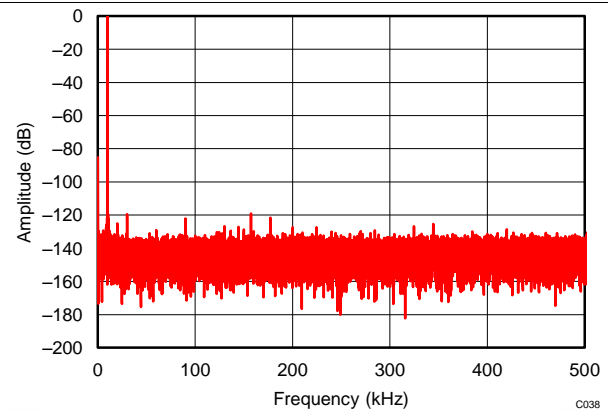
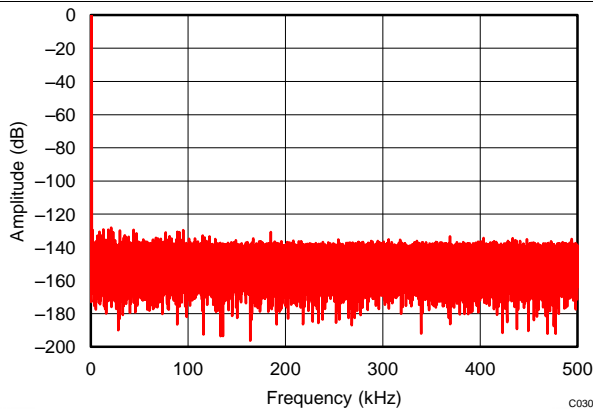

Figure 24. Typical FFT Plot

Typical Characteristics (continued)

at  $T_A = 25^\circ\text{C}$ ,  $I_L = 0\text{ mA}$ , and  $V_{IN} = 5\text{ V}$ , using REF6225 (unless otherwise noted)



REF6241 driving REF pin of ADS8881,  
 $f_{IN} = 1\text{ kHz}$ , SNR = 99 dB, THD = -124.4 dB

Figure 25. Typical FFT Plot

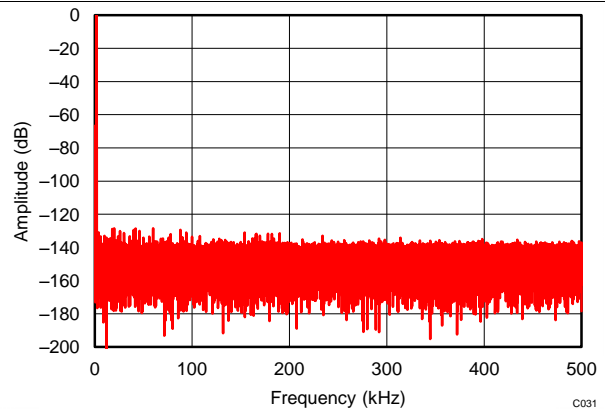

REF6241 driving REF pin of ADS8881,  
 $f_{IN} = 2\text{ kHz}$ , SNR = 99 dB, THD = -123.6 dB

Figure 26. Typical FFT Plot

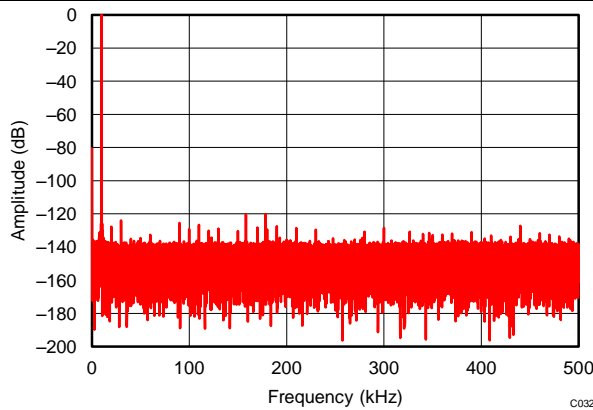

REF6241 driving REF pin of ADS8881,  
 $f_{IN} = 10\text{ kHz}$ , SNR = 97.2 dB, THD = -119.7 dB

Figure 27. Typical FFT Plot

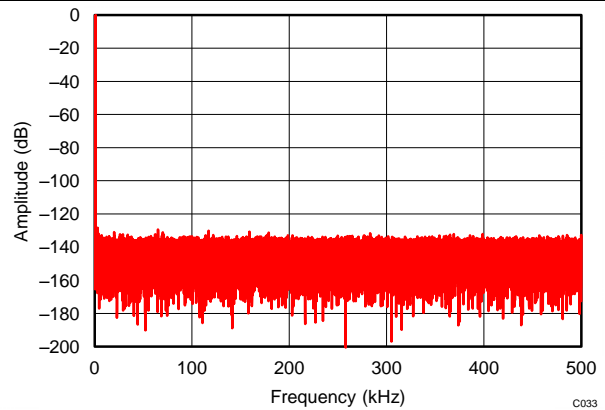

REF6225 driving REF pin of ADS8881,  
 $f_{IN} = 1\text{ kHz}$ , SNR = 95.4 dB, THD = -124 dB

Figure 28. Typical FFT Plot

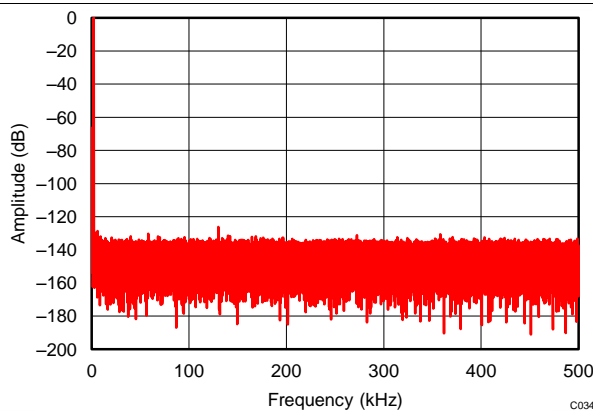

REF6225 driving REF pin of ADS8881,  
 $f_{IN} = 2\text{ kHz}$ , SNR = 95.4 dB, THD = -123.5 dB

Figure 29. Typical FFT Plot

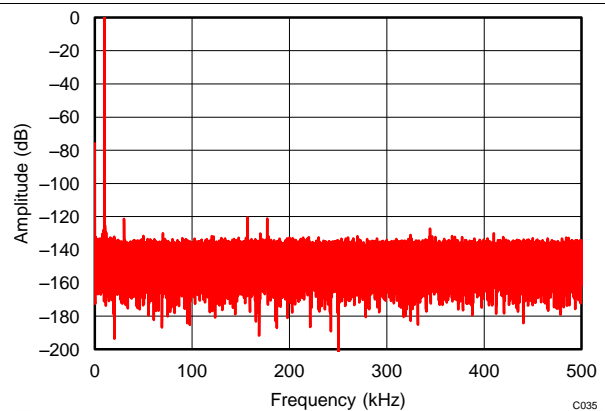

REF6225 driving REF pin of ADS8881,  
 $f_{IN} = 10\text{ kHz}$ , SNR = 94.0 dB, THD = -119.3 dB

Figure 30. Typical FFT Plot

### Typical Characteristics (continued)

at  $T_A = 25^\circ\text{C}$ ,  $I_L = 0\text{ mA}$ , and  $V_{IN} = 5\text{ V}$ , using REF6225 (unless otherwise noted)

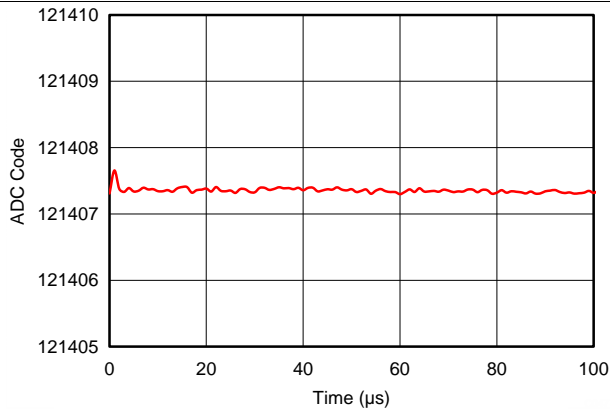

REF6250 driving REF pin of ADS8881 operating at 1 MSPS, positive full-scale input to ADS8881

**Figure 31. Reference Droop**

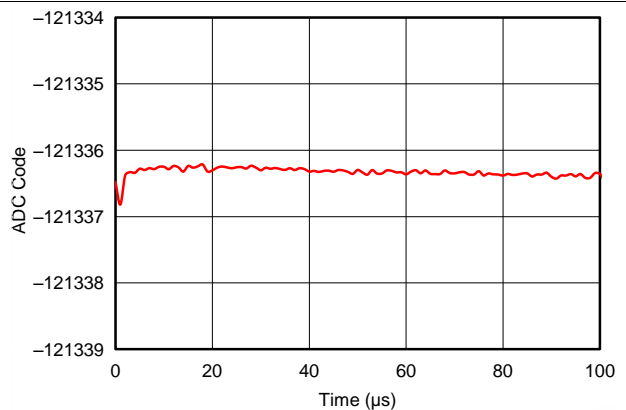

REF6250 driving REF pin of ADS8881 operating at 1 MSPS, negative full-scale input to ADS8881

**Figure 32. Reference Droop**

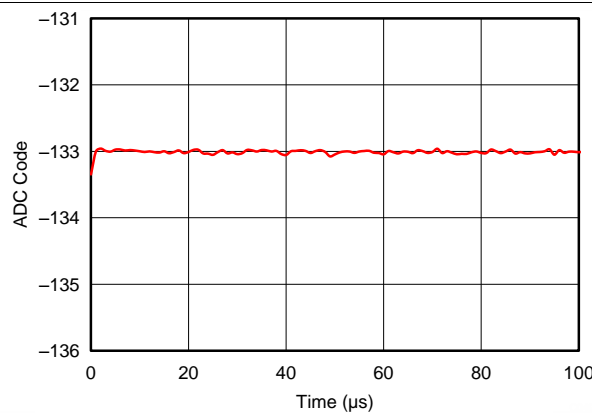

REF6250 driving REF pin of ADS8881 operating at 1 MSPS,  $A_{INP} = A_{INN} = V_{REF} / 2$  for ADS8881

**Figure 33. Reference Droop**

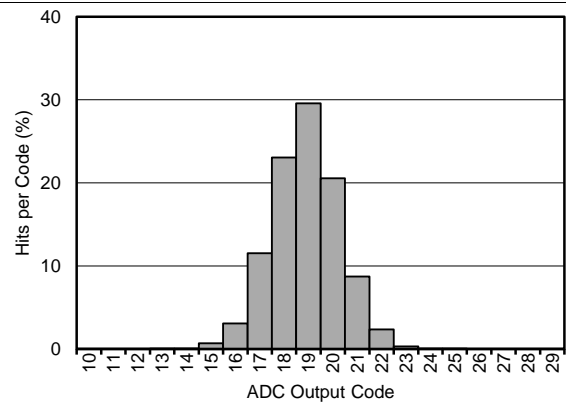

$A_{INP} = A_{INN} = V_{REF} / 2$  for ADS8881, sampling rate = 1 MSPS

**Figure 34. DC Input Histogram**

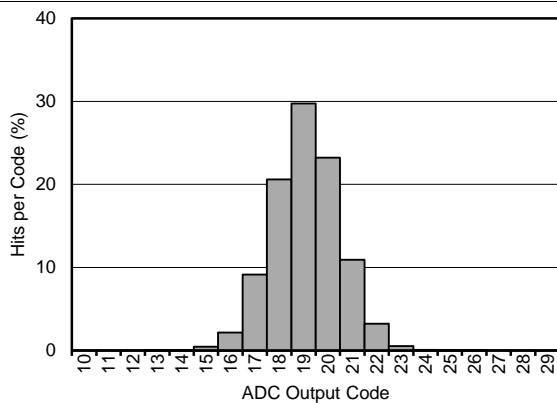

$A_{INP} = A_{INN} = V_{REF} / 2$  for ADS8881, sampling rate = 500 kSPS

**Figure 35. DC Input Histogram**

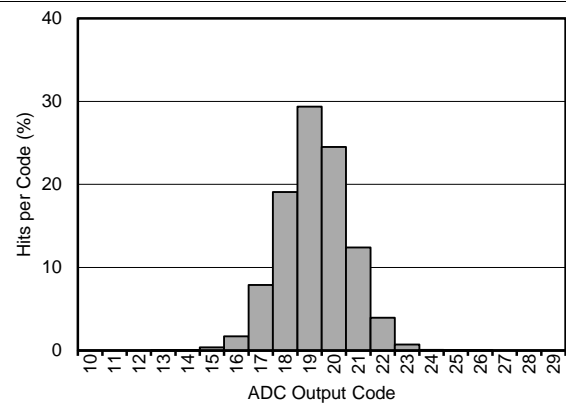

$A_{INP} = A_{INN} = V_{REF} / 2$  for ADS8881, sampling rate = 100 kSPS

**Figure 36. DC Input Histogram**

Typical Characteristics (continued)

at  $T_A = 25^\circ\text{C}$ ,  $I_L = 0\text{ mA}$ , and  $V_{IN} = 5\text{ V}$ , using REF6225 (unless otherwise noted)

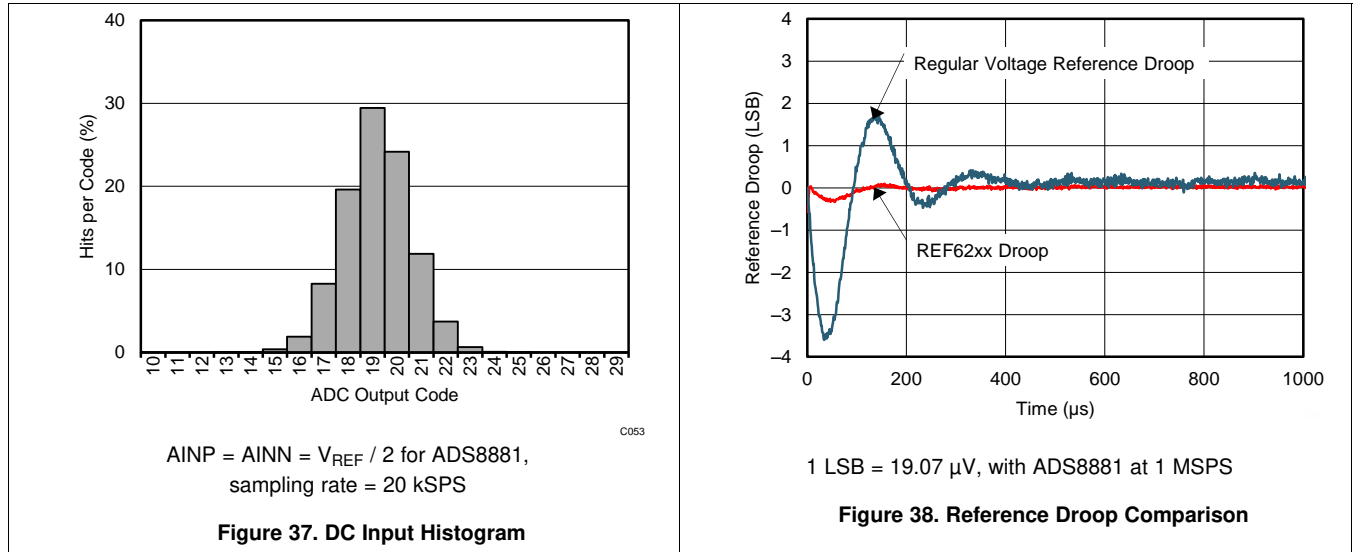

## 8 Parameter Measurement Information

### 8.1 Solder Heat Shift

The materials used in the manufacture of the REF62xx have differing coefficients of thermal expansion, and result in stress on the device die when the part is heated. Mechanical and thermal stress on the device die sometimes causes the output voltages to shift, degrading the initial accuracy specifications of the product. Reflow soldering is a common cause of this error.

In order to illustrate this effect, a total of 128 devices were soldered on eight printed circuit boards (PCBs), with 16 devices on each PCB, using lead-free solder paste, and the manufacturer-suggested reflow profile. The reflow profile is as shown in [Figure 39](#). The printed circuit board is comprised of FR4 material. The board thickness is 1.65 mm and the area is 101.6 mm × 127 mm.

The reference output voltage is measured before and after the reflow process; the typical shift is displayed in [Figure 40](#). Although all tested units exhibit very low shifts (< 0.03%), higher shifts are also possible depending on the size, thickness, and material of the PCB.

The histogram displays the typical shift for exposure to a single reflow profile. Exposure to multiple reflows, as is common on PCBs with surface-mount components on both sides, causes additional shifts in the output bias voltage. If the PCB is exposed to multiple reflows, solder the device in the final pass to minimize exposure to thermal stress.

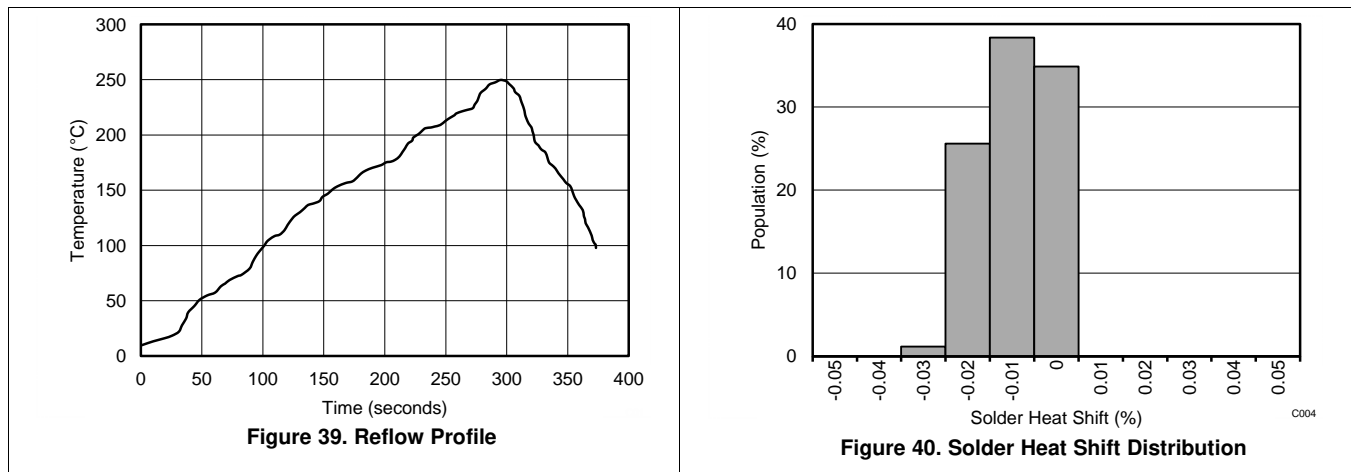

## 8.2 Thermal Hysteresis

Thermal hysteresis for the device is defined as the change in output voltage after operating the device at 25°C, cycling the device through the specified temperature range, and returning to 25°C. Thermal hysteresis was measured with the REF62xx soldered to a PCB, similar to a real-world application. The PCB was baked at 150°C for 30 minutes before thermal hysteresis was measured. Thermal hysteresis is expressed as:

$$V_{\text{HYST}} = \left( \frac{|V_{\text{PRE}} - V_{\text{POST}}|}{V_{\text{NOM}}} \right) \cdot 10^6 \text{ (ppm)}$$

where

- $V_{\text{HYST}}$  = thermal hysteresis (in units of ppm).
- $V_{\text{NOM}}$  = the specified output voltage.
- $V_{\text{PRE}}$  = output voltage measured at 25°C pretemperature cycling.
- $V_{\text{POST}}$  = output voltage measured after the device has cycled from 25°C through the specified temperature range of 0°C to 70°C and returns to 25°C. (1)

Typical thermal hysteresis distribution is shown in [Figure 41](#) and [Figure 42](#).

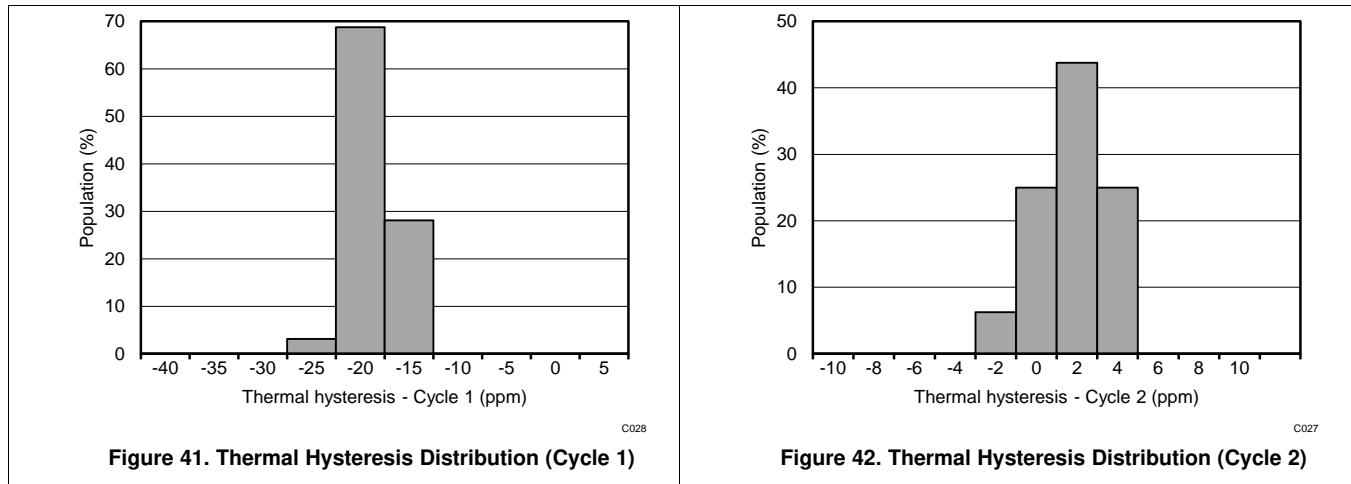

### 8.3 Reference Droop Measurements

Many applications, such as event-triggered and multiplexed data-acquisition systems, require the very first conversion of the ADC to have 18-bit or greater precision. These types of data-acquisition systems capture data in bursts, and are also called burst-mode, data-acquisition systems. Achieving 18-bit precision for the first sample is a very difficult using a conventional voltage reference because the voltage reference droop limits the accuracy of the first few conversions. The REF62xx have an integrated ADC drive buffer that makes sure the reference droop is less than 1 LSB at 18-bit precision when used with the ADS8881, even at full throughput. [Figure 43](#) and [Figure 44](#) show the REF62xx output voltage droop when driving the REF pin of the ADS8881 at positive and negative full-scale inputs, respectively.

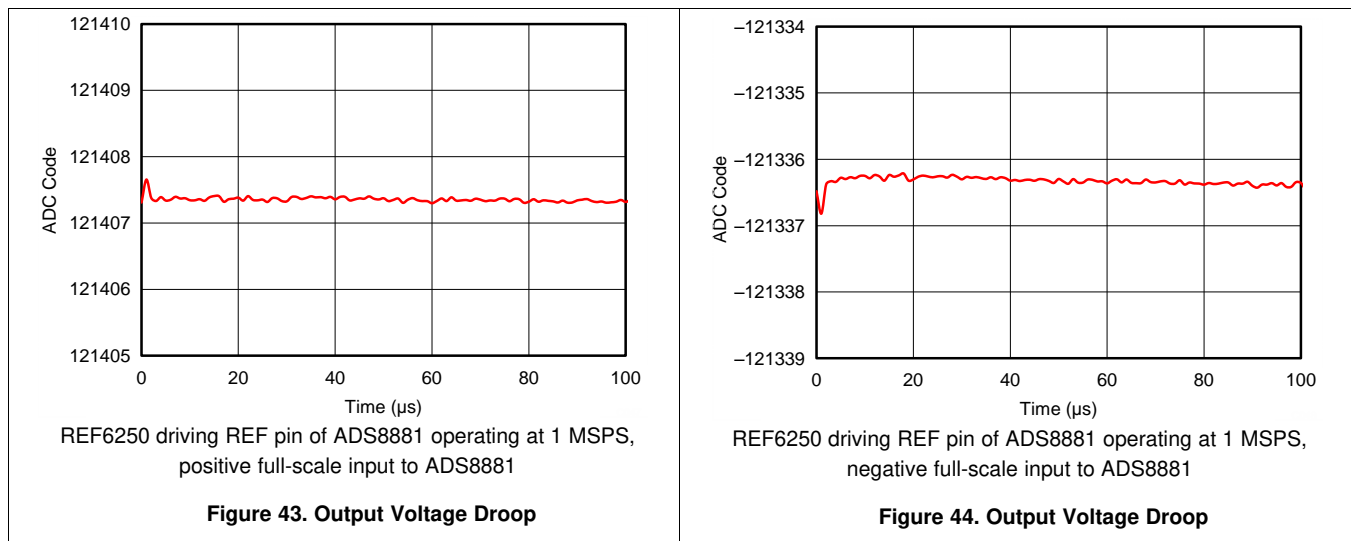

Direct measurement of the reference droop to 18-bit accuracy can be a challenging process. Therefore, the plots in [Figure 43](#) and [Figure 44](#) were obtained by processing the output code of the ADC. The ADC output code is given by:

$$C = (\text{Input Voltage} / V_{\text{REF}}) \times 2^N \quad (2)$$

If the input voltage is kept constant,  $V_{\text{REF}}$  is computed by monitoring the ADC output code  $C$ . The ADC code usually has six to seven LSBs of code spread due to the inherent noise of the ADC. In order to measure reference droop, this noise must be reduced drastically. Noise reduction is done by averaging the output code multiple times, as described in the next paragraph.



## Reference Droop Measurements (continued)

Figure 45 shows the setup that was used to measure the reference droop. The output ADC code was captured using a field-programmable gate array (FPGA), and post-processing was done on a personal computer. The input to the THS4521, and hence in turn to the ADS8881, is a constant dc voltage (close to positive or negative full-scale because this condition is the worst-case for charge drawn from the REF pin). The dc source must have extremely low noise. After the REF62xx device is powered up and stable, the FPGA sends commands to the ADS8881 to capture data in bursts. The ADS8881 is initially in idle mode for 100 ms. The FPGA then sends a command to the ADS8881 to perform 100 conversions at 1 MSPS. The ADC code corresponding to these 100 conversions (one burst of data) is stored as the first row in a 1000 × 100 dimensional array. This operation is repeated 1000 times, and the data corresponding to each burst is stored in a new row of the 1000 × 100 dimensional array. Finally, each column in this array is averaged to get a final data-set of 100 elements. This final data-set now has code spread that is much less than 1 LSB because most of the noise has now been removed through averaging. This data-set was plotted on a graph with X axis = column number (each column number corresponds to 1 μs of time because the sampling rate is 1 MSPS), and Y axis = ADC output code to obtain reference-droop measurements.

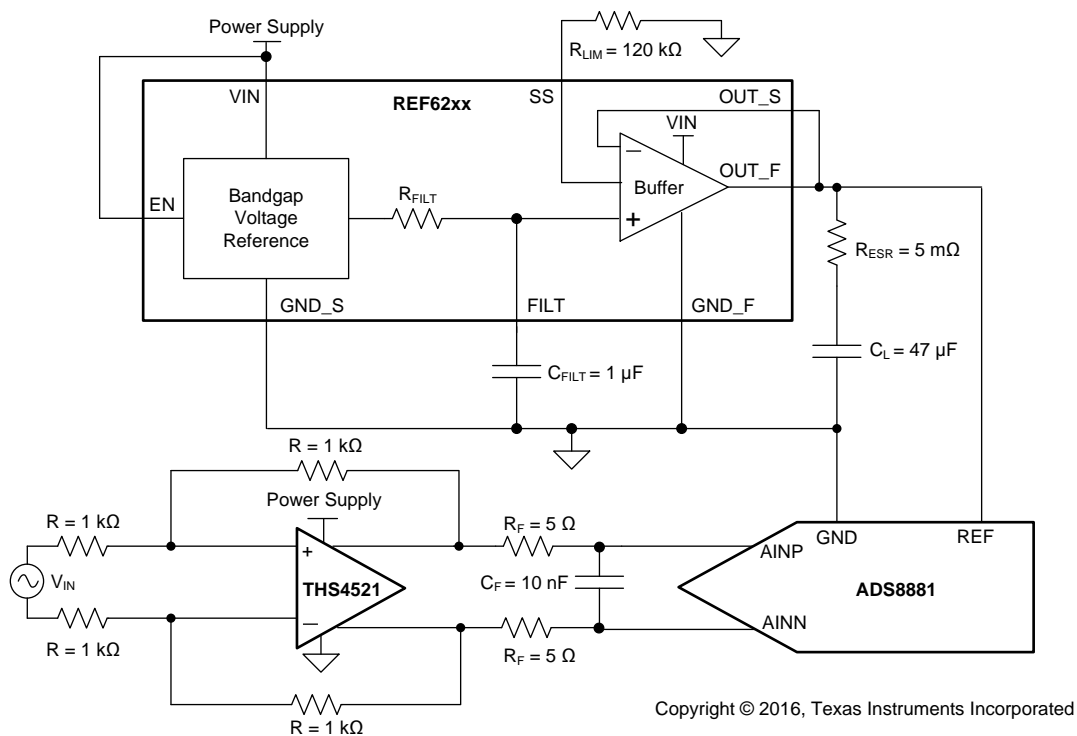
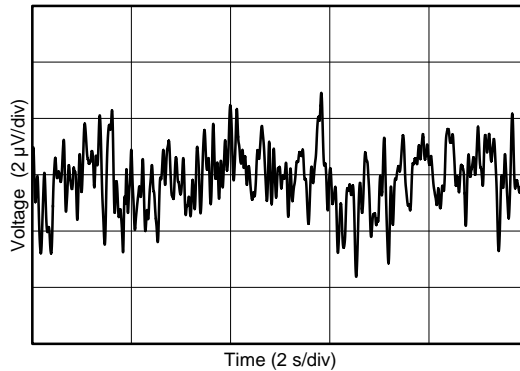

Figure 45. Burst-Mode Measurement Setup

### 8.4 1/f Noise Performance

Typical 0.1-Hz to 10-Hz voltage noise for the REF6225 is shown in Figure 46. The 1/f noise scales with output voltage, but remains  $3 \mu\text{V}_{\text{pp}}/\text{V}$  for all the variants. Peak-to-peak noise measurement setup is shown in Figure 47.



C021

Figure 46. 0.1-Hz to 10-Hz Noise

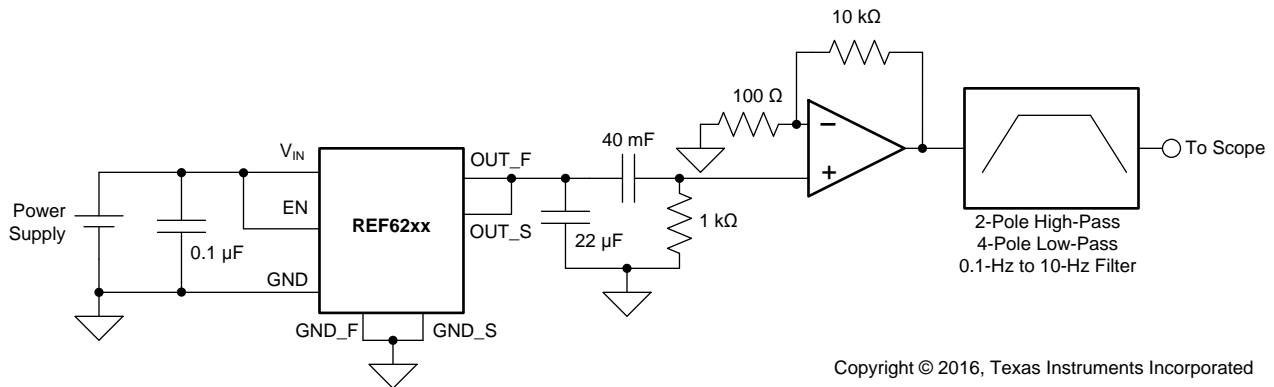

Copyright © 2016, Texas Instruments Incorporated

Figure 47. 0.1-Hz to 10-Hz Noise Measurement Setup

## 9 Detailed Description

### 9.1 Overview

Most SAR ADCs, and a few delta-sigma ADCs, switch binary-weighted capacitors onto the REF pin during the conversion process. The magnitude of the capacitance switched onto the REF pin during each conversion depends on the input signal to the ADC. If a voltage reference is directly connected to the REF pin of these ADCs, the reference voltage droops because of the dynamic input signal dependent load of the binary-weighted capacitors. Because the reference voltage droop now has input signal dependence, significant degradation in THD and linearity for the system occurs.

In order to support this dynamic load and preserve the ADC linearity, distortion and noise performance, the output of the voltage reference must be buffered with a low-output impedance (high-bandwidth) buffer. The REF62xx family of voltage references have an integrated low output impedance buffer that enables the user to directly drive the REF pin of a SAR ADC, while preserving ADC linearity and distortion. In addition, the total noise in the full bandwidth of the REF62xx is extremely low, thus preserving the noise performance of the ADC. [Voltage-Reference Impact on Total Harmonic Distortion \(SLYY097\)](#) correlates the effect of reference settling to ADC distortion, and how the REF62xx achieves lowest distortion with minimal components and lowest power consumption.

The output voltage of the REF62xx does not droop below 1 LSB (18-bit), even during the first conversion while driving the REF pin of the ADS8881. This feature is useful in burst-mode, event-triggered, equivalent-time sampling, and variable-sampling-rate data-acquisition systems. [Functional Block Diagram](#) shows a simplified schematic of the REF62xx.

### 9.2 Functional Block Diagram

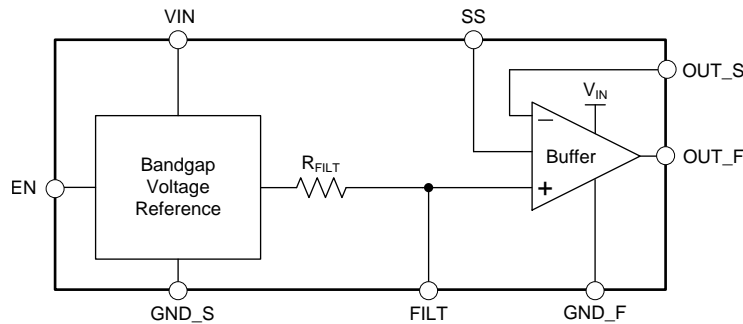

## 9.3 Feature Description

### 9.3.1 Integrated ADC Drive Buffer

Many ADC data sheets specify a few microamps of average current draw from the REF pin. Almost all voltage references provide these few microamps of average current; but not all voltage references are practical for driving a high-resolution, high-throughput SAR ADC because the peak current drawn can be very high when the capacitors are switched on the REF pin. The worst-case demand for the voltage reference is during a burst-mode conversion, when the ADC is idle for a very long time, before a conversion is initiated, and the first sample converted is expected to be precise. Usually, a large capacitor is connected between the REF pin and ground pin (or sometimes between the REFP and REFM pins) of the ADC to smoothen the current load and reduce the burden on the voltage reference. The voltage reference must then be capable of providing the average current required to completely charge the reference capacitor, but without causing the reference voltage to droop significantly. Most voltage references lack the ability to completely charge the reference capacitor, and settle when the binary-weighted capacitors are being switched onto the REF pin because of the large output impedance. Usually, voltage references have output impedances in the range of 10's of ohms at frequencies higher than 100 Hz. The output voltage of the voltage reference must be buffered with a low output impedance (usually high bandwidth) amplifier to achieve excellent linearity and distortion performance.

The key amplifier specifications to be considered when designing a reference buffer for a high-precision ADC are: low offset, low drift, wide bandwidth, and low output impedance. While it is possible to select an amplifier that sufficiently meets all these requirements, the amplifier comes at a cost of excessive power consumption. For example, the [OPA350](#) is a 38-MHz bandwidth amplifier with a maximum offset of 0.5 mV, and low offset drift of 4  $\mu\text{V}/^\circ\text{C}$ , but consumes a quiescent current of 5.2mA. This is because (from an amplifier design perspective) offset and drift are dc specifications, whereas bandwidth, low output impedance, and high capacitive drive capability are high-frequency specifications. Therefore, achieving all the performance in one amplifier requires power. However, a more efficient design to meet the low power budget is to use a composite reference buffer, which uses an amplifier with superior high-frequency specifications in the feedback loop of a dc precision amplifier to get the overall performance at much lower power consumption. [Figure 48](#) shows such a composite amplifier design with the [OPA333](#) (dc precision amplifier) and [THS4281](#) (high-bandwidth amplifier). This reference buffer design requires three devices, and a large number of external components. This solution still consumes close to 2 mA of quiescent current.

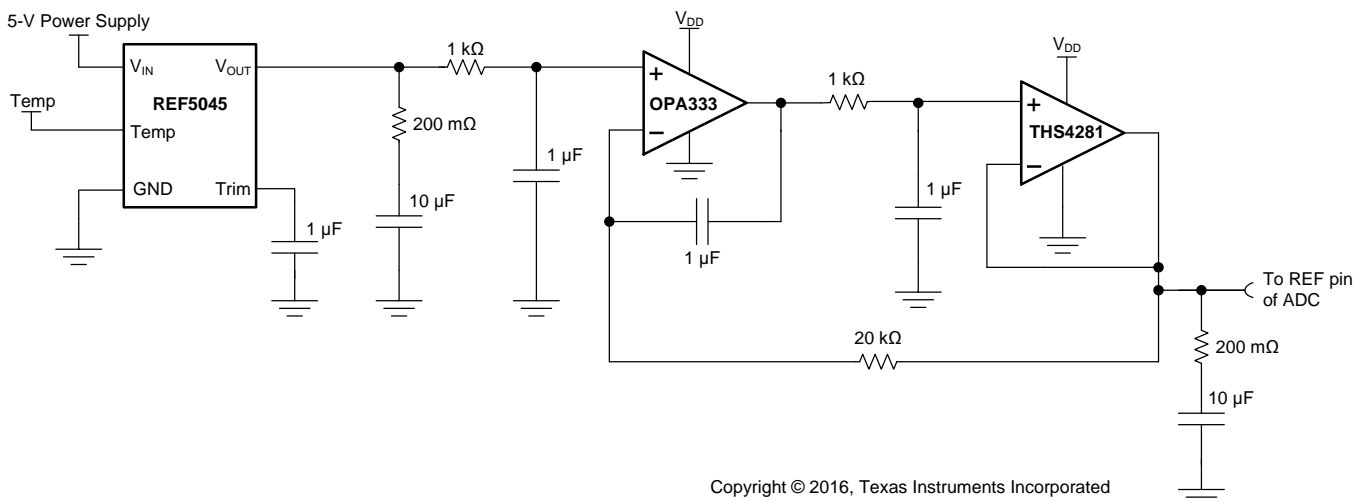

**Figure 48. Composite Amplifier Reference Buffer**

The REF62xx family of voltage references have an integrated low output impedance buffer (ADC drive buffer); therefore, there is no need for an external buffer while driving the REF pin of high-precision, high-throughput SAR ADCs, as shown in [Figure 49](#). The ADC drive buffer of the REF62xx is capable of replenishing a charge of 70 pC on a 47- $\mu\text{F}$  capacitor in 1  $\mu\text{s}$ , without allowing the voltage on the capacitor to droop more than 1 LSB at 18-bit precision. The REF62xx are trimmed at multiple temperatures in production, achieving a max drift of just 3

Feature Description (continued)

ppm/°C between 0°C and 70 °C for both the voltage reference and the buffer combined, while operating at a typical quiescent current of 820  $\mu$ A. The reference drift is guaranteed from 0°C and 70 °C. The REF62xx can operate from -55°C to 125°C without getting damaged. Figure 50 compares the output impedance of a regular voltage reference (REF20xx) and a voltage reference with integrated ADC drive buffer (REF62xx). Figure 51 compares the burst-mode, reference-settling performance of a regular voltage reference and the REF62xx.

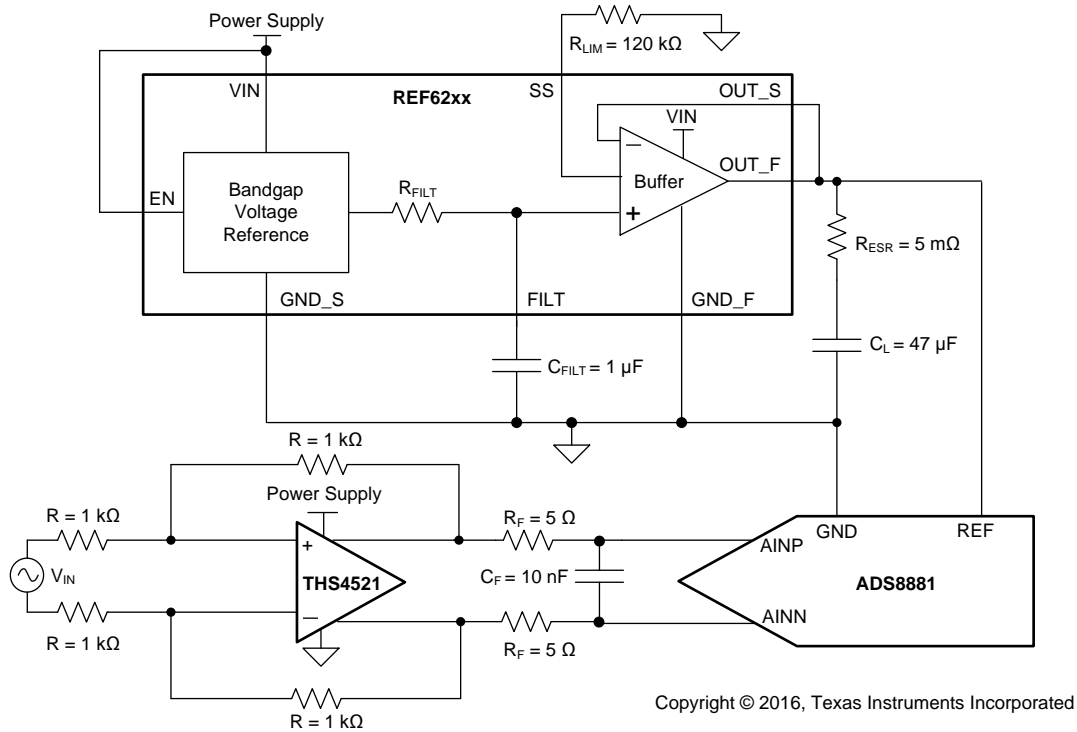
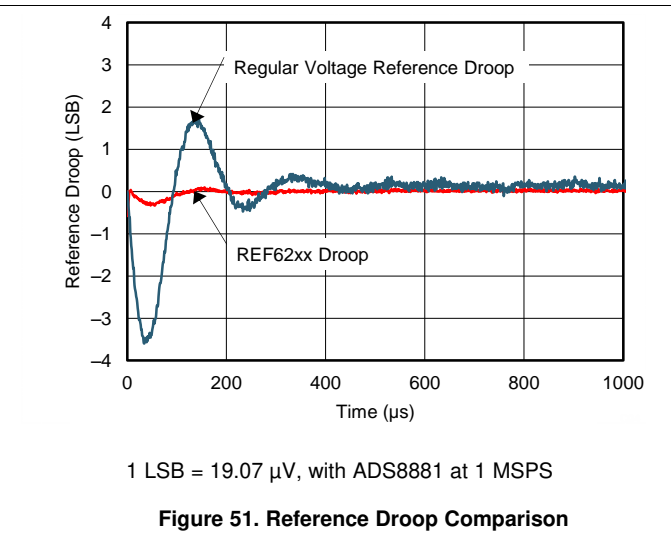
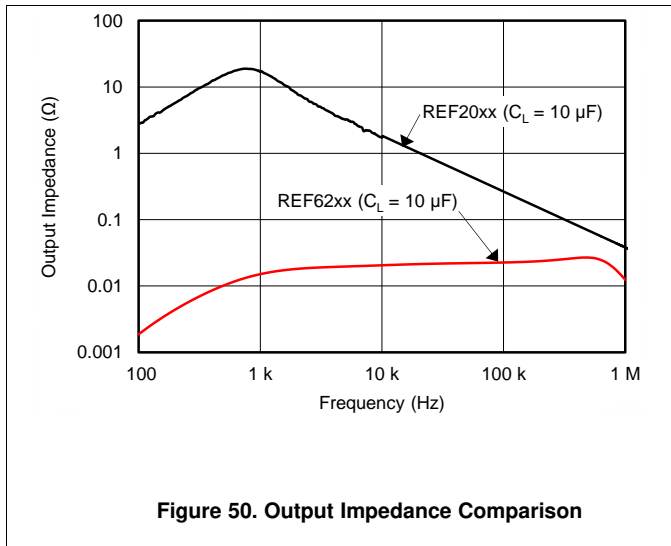

Figure 49. REF62xx Driving REF Pin of ADS8881 SAR ADC



## Feature Description (continued)

### 9.3.2 Temperature Drift

The REF62xx family is designed for minimal drift error, defined as the change in output voltage over temperature. The drift is calculated using the box method, as described by the following equation:

$$\text{Drift} = \left( \frac{V_{\text{REF(MAX)}} - V_{\text{REF(MIN)}}}{V_{\text{REF}} \cdot \text{Temperature Range}} \right) \cdot 10^6 \quad (\text{ppm}) \quad (3)$$

### 9.3.3 Load Current

The REF6225, REF6230, REF6233 and REF6241 are specified to deliver current load of  $\pm 4$  mA. The REF6245 is specified to deliver  $\pm 3.5$  mA, and the REF6250 is specified to deliver  $\pm 3$  mA. The REF62xx are protected from short circuits at the output by limiting the output short-circuit current.

The short-circuit current limit ( $I_{\text{SC}}$ ) of the REF62xx family of devices is adjusted by connecting a resistor ( $R_{\text{SS}}$ ) on the SS pin. The short-circuit current limit when the REF62xx device is sourcing current can be calculated as shown in [Equation 4](#):

$$I_{\text{SC}} = (80 \cdot 10^{-9}) \cdot R_{\text{SS}} + (3 \cdot 10^{-3}) \quad (4)$$

The short circuit current limit when the REF62xx device is sinking is calculated as shown in [Equation 5](#):

$$I_{\text{SC}} = (115 \cdot 10^{-9}) \cdot R_{\text{SS}} + (4.6 \cdot 10^{-3}) \quad (5)$$

The recommended output current of the REF62xx also depends on the resistor connected to the SS pin. The recommended output current (sourcing and sinking) for the REF6225, REF6230, REF6233 and REF6241 is given by [Equation 6](#):

$$I_{\text{L}} = (31.25 \cdot 10^{-9}) \cdot R_{\text{SS}} + (0.25 \cdot 10^{-3}) \quad (6)$$

The recommended output current (sourcing and sinking) for the REF6245 is given by [Equation 7](#):

$$I_{\text{L}} = (27.08 \cdot 10^{-9}) \cdot R_{\text{SS}} + (0.25 \cdot 10^{-3}) \quad (7)$$

The recommended output current (sourcing and sinking) for the REF6250 is given by [Equation 8](#):

$$I_{\text{L}} = (23.75 \cdot 10^{-9}) \cdot R_{\text{SS}} + (0.15 \cdot 10^{-3}) \quad (8)$$

The temperature of the device increases according to [Equation 9](#):

$$T_{\text{J}} = T_{\text{A}} + P_{\text{D}} \cdot R_{\theta\text{JA}}$$

where:

- $T_{\text{J}}$  = junction temperature ( $^{\circ}\text{C}$ ).
  - $T_{\text{A}}$  = ambient temperature ( $^{\circ}\text{C}$ ).
  - $P_{\text{D}}$  = power dissipated (W).
  - $R_{\theta\text{JA}}$  = junction-to-ambient thermal resistance ( $^{\circ}\text{C}/\text{W}$ ).
- (9)

The REF62xx maximum junction temperature must not exceed the absolute maximum rating of  $150^{\circ}\text{C}$ .

## Feature Description (continued)

### 9.3.4 Stability

The REF62xx family of voltage references are stable with output capacitor values ranging from 10  $\mu\text{F}$  to 47  $\mu\text{F}$ . At a low output-capacitor value of 10  $\mu\text{F}$ , an effective series resistance (ESR) of 20 m $\Omega$  to 100 m $\Omega$  is required for stability; whereas, at a higher value of 47  $\mu\text{F}$ , an ESR of 5 m $\Omega$  to 100 m $\Omega$  is required. The shaded region in [Figure 52](#) shows the stable region of operation for the REF62xx devices.

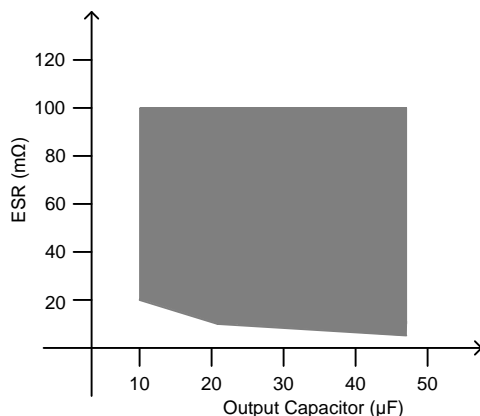

**Figure 52. Stable Output Capacitor Range**

A capacitor of value 1  $\mu\text{F}$  is required at the FILT pin for stability and noise performance. A low ESR (5 m $\Omega$  to 20 m $\Omega$ ) is easily achieved by increasing the PCB trace length, thus eliminating the need for a discrete resistor. Higher values of ESR (greater than 20 m $\Omega$ , but lesser than 100 m $\Omega$ ) can be intentionally added to increase the output bandwidth of the REF62xx. This higher ESR improves the transient performance of the REF62xx, but worsens noise performance because of increased bandwidth.

## 9.4 Device Functional Modes

When the EN pin of the REF62xx is pulled high, the device is in active mode. The device must be in active mode for normal operation.

To place the REF62xx into a shutdown mode, pull the ENABLE pin low. When in shutdown mode, the output of the device becomes high impedance and the quiescent current of the device reduces to 1  $\mu\text{A}$  (typ). See the enable pin voltage parameter in the [Electrical Characteristics](#) table for logic high and logic low voltage levels.

## 10 Applications and Implementation

### NOTE

Information in the following applications sections is not part of the TI component specification, and TI does not warrant its accuracy or completeness. TI's customers are responsible for determining suitability of components for their purposes. Customers should validate and test their design implementation to confirm system functionality.

### 10.1 Application Information

Many applications, such as event-triggered and multiplexed data-acquisition systems, require the very first conversion of the ADC to have 18-bit or greater precision. These types of data acquisition systems capture data in bursts, and are also called burst-mode, data-acquisition systems. Achieving 18-bit precision for the first sample is very difficult using a conventional voltage reference because the voltage reference droop limits the accuracy of the first few conversions. Furthermore, variable-sampling-rate systems require that the gain error of the system does not vary with sampling rate. The primary objective of this design example is to demonstrate the lowest distortion and noise, burst-mode data-acquisition block with low power consumption, using an 18-bit SAR ADC operating at a throughput of 1 MSPS, for a 1-kHz, full-scale, pure sine-wave input.

### 10.2 Typical Application

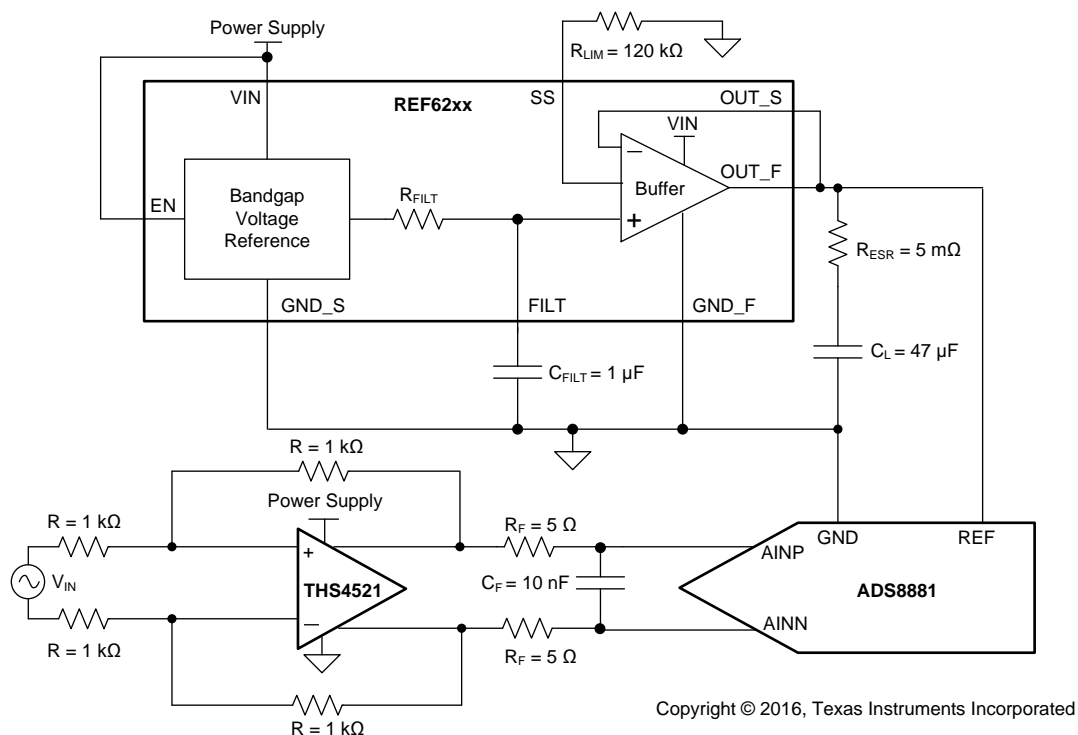

Figure 53. 18-bit, 1-MSPS, Burst-Mode Data Acquisition system

#### 10.2.1 Design Requirements

1. Burst-mode support (see [Reference Droop Measurements](#) section for more details)
2. ENOB > 16 bits
3. THD < -120 dB
4. Power consumption < 50 mW
5. Throughput = 1 MSPS



## Typical Application (continued)

### 10.2.2 Detailed Design Procedure

The data acquisition system shown in [Figure 53](#) has three major contributors to the noise and accuracy in the system: the input driver, the reference with driver, and the data converter. Each analog block is carefully designed so that the data converter specifications limit the system specifications. The [THS4551](#), a fully differential operational amplifier is used to drive the 18-bit ADC ([ADS8881](#)). The charge-kickback RC filter at the output of the THS4551 is used to reduce the charge kickback created by the opening and closing of the sampling switch inside the ADC. Design the RC filter so that the voltage at the sampling capacitor settles to 18-bit accuracy within the acquisition time of the ADC.

Data-acquisition systems require stable and accurate voltage references in order to perform the most accurate data conversion. The REF62xx family of voltage references have integrated an ADC drive buffer, and can therefore drive the REF pin of the ADS8881 directly, without the need for an external reference buffer. See the [Integrated ADC Drive Buffer](#) section for more details about reference-buffer requirements. Correct output capacitor selection for the REF62xx is very important in this design. The [Stability](#) section describes the ESR requirements of the output capacitor for stability and burst-mode requirements. A capacitance of 1  $\mu$ F is connected to the FILT pin to reduce broadband noise of the REF62xx.

#### 10.2.2.1 Results

[Table 1](#) summarizes the measured results.

**Table 1. Measured Results**

SPECIFICATION	MEASURED RESULT
SNR	100.5 dB
ENOB	16.4
THD	-125.9 dB
Throughput	1 MSPS
Burst mode	First sample > 18-bit precision
Power consumption	40 mW

### 10.2.3 Application Curves

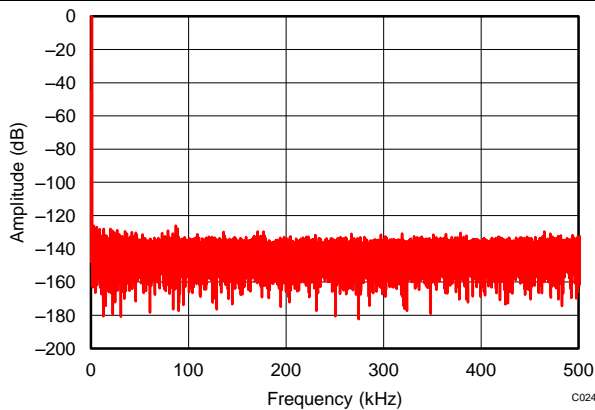

REF6250 driving REF pin of ADS8881,  
 $f_{IN} = 1 \text{ kHz}$ , SNR = 100.5 dB, THD = -125.9 dB

**Figure 54. Typical FFT Plot**

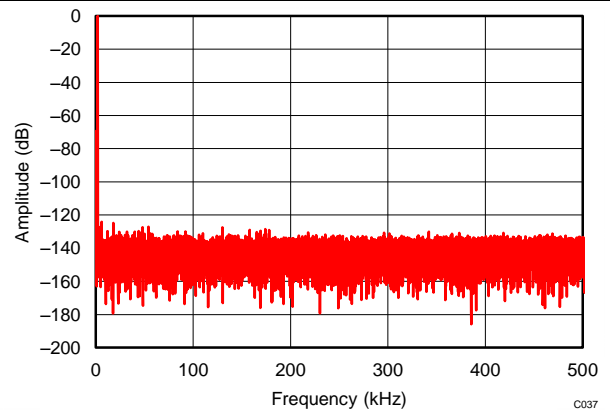

REF6250 driving REF pin of ADS8881,  
 $f_{IN} = 2 \text{ kHz}$ , SNR = 100.4 dB, THD = -123.9 dB

**Figure 55. Typical FFT Plot**

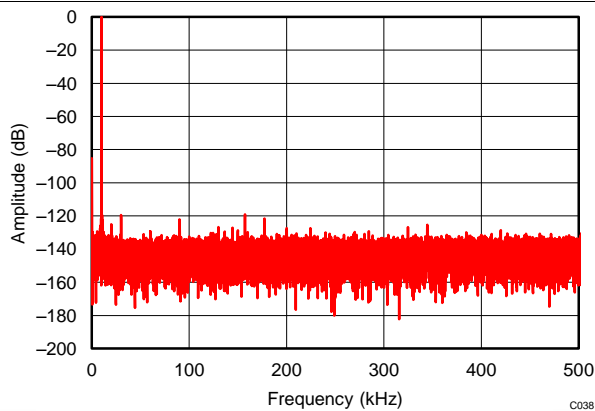

REF6250 driving REF pin of ADS8881,  
 $f_{IN} = 10 \text{ kHz}$ , SNR = 99.2 dB, THD = -119.4 dB

**Figure 56. Typical FFT Plot**

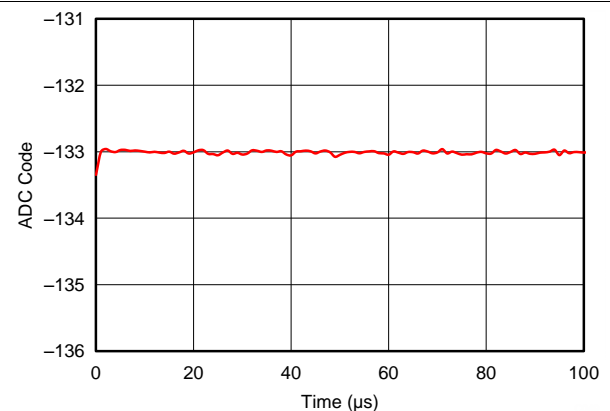

REF6250 driving REF pin of ADS8881 operating at 1 MSPS,  
 $A_{INP} = A_{INN} = V_{REF} / 2$  for ADS8881

**Figure 57. Reference Droop**

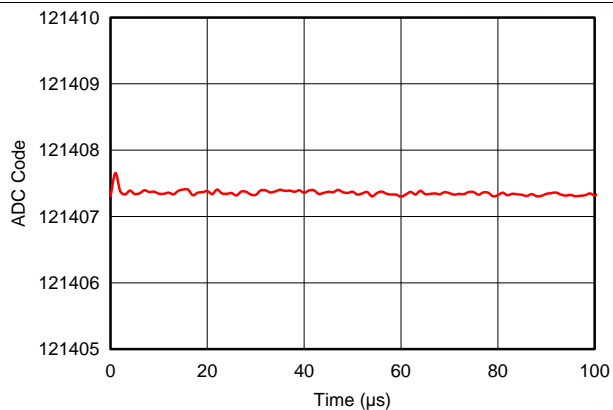

REF6250 driving REF pin of ADS8881 operating at 1 MSPS,  
 positive full-scale input to ADS8881

**Figure 58. Reference Droop**

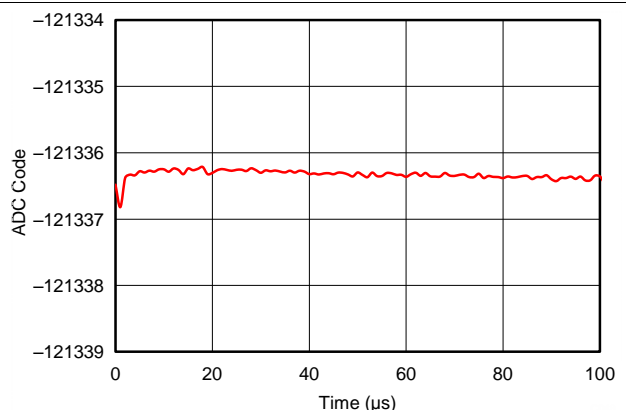

REF6250 driving REF pin of ADS8881 operating at 1 MSPS,  
 negative full-scale input to ADS8881

**Figure 59. Reference Droop**

## 11 Power Supply Recommendations

The REF62xx family of references have extremely low dropout voltage. The dropout specifications can be found in the [Electrical Characteristics](#) section. A minimum 0.1  $\mu\text{F}$  decoupling capacitor must be connected between the VIN and GND\_F pins of the REF62xx. A typical dropout voltage versus load is shown in [Figure 60](#).

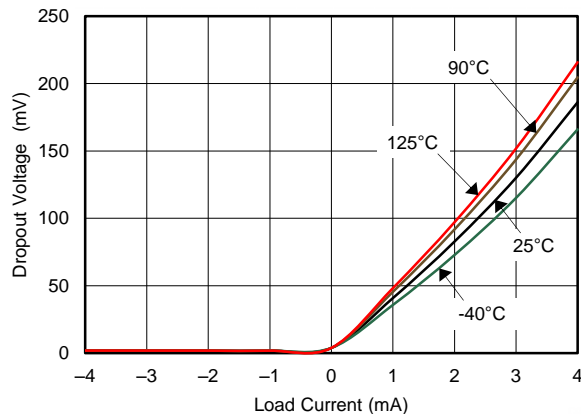

**Figure 60. Dropout Voltage vs Load Current**

## 12 Layout

### 12.1 Layout Guidelines

Figure 61 illustrates an example of a PCB layout for a data-acquisition system using the REF62xx. Some key considerations are:

- Connect low-ESR, 0.1- $\mu$ F ceramic bypass capacitors between the VIN pin and ground.
- Place the REF62xx output capacitor ( $C_L$ ) and the ADC as close to each other as possible.
- Run two separate traces between VOUT\_F, VOUT\_S and the output capacitor, as shown in Figure 61.
- Short the GND\_F and GND\_S pins with a solid plane, and extend this plane to connect to the output capacitor  $C_L$ , as shown in Figure 61.
- Use a solid ground plane to help distribute heat and reduces electromagnetic interference (EMI) noise pickup.
- Place the external components as close to the device as possible. This configuration prevents parasitic errors (such as the Seebeck effect) from occurring.
- Do not run sensitive analog traces in parallel with digital traces. Avoid crossing digital and analog traces if possible, and only make perpendicular crossings when absolutely necessary.

### 12.2 Layout Example

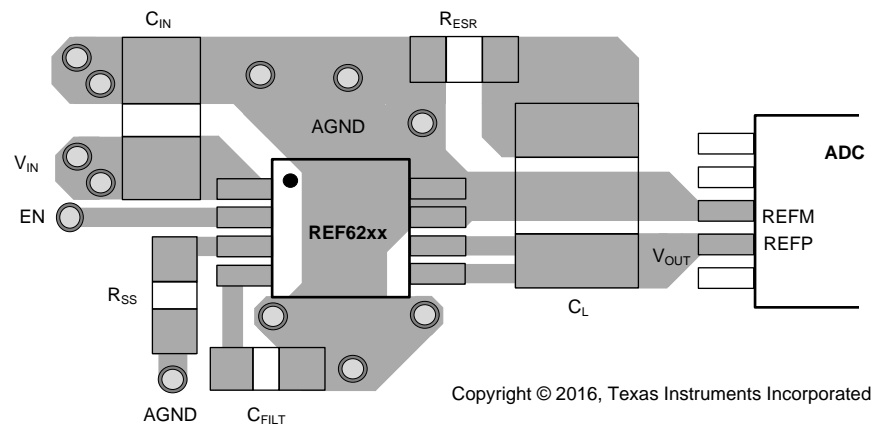

**Figure 61. Layout Example**

## 13 Device and Documentation Support

### 13.1 Documentation Support

#### 13.1.1 Related Documentation

For related documentation see the following:

- [ADS8881x 18-Bit, 1-MSPS, Serial Interface, microPower, Miniature, True-Differential Input, SAR Analog-to-Digital Converter Data Sheet](#) (SBAS547)
- [ADS127L01 24-Bit, High-Speed, Wide-Bandwidth Analog-to-Digital Converter Data Sheet](#) (SBAS607)
- [REF6025EVM-PDK User's Guide](#) (SBAU258)
- [Voltage-Reference Impact on Total Harmonic Distortion](#) (SLYY097)

### 13.2 Related Links

The following table lists quick access links. Categories include technical documents, support and community resources, tools and software, and quick access to sample or buy.

**Table 2. Related Links**

PARTS	PRODUCT FOLDER	SAMPLE & BUY	TECHNICAL DOCUMENTS	TOOLS & SOFTWARE	SUPPORT & COMMUNITY
REF6225	<a href="#">Click here</a>	<a href="#">Click here</a>	<a href="#">Click here</a>	<a href="#">Click here</a>	<a href="#">Click here</a>
REF6230	<a href="#">Click here</a>	<a href="#">Click here</a>	<a href="#">Click here</a>	<a href="#">Click here</a>	<a href="#">Click here</a>
REF6233	<a href="#">Click here</a>	<a href="#">Click here</a>	<a href="#">Click here</a>	<a href="#">Click here</a>	<a href="#">Click here</a>
REF6241	<a href="#">Click here</a>	<a href="#">Click here</a>	<a href="#">Click here</a>	<a href="#">Click here</a>	<a href="#">Click here</a>
REF6245	<a href="#">Click here</a>	<a href="#">Click here</a>	<a href="#">Click here</a>	<a href="#">Click here</a>	<a href="#">Click here</a>
REF6250	<a href="#">Click here</a>	<a href="#">Click here</a>	<a href="#">Click here</a>	<a href="#">Click here</a>	<a href="#">Click here</a>

### 13.3 Receiving Notification of Documentation Updates

To receive notification of documentation updates, navigate to the device product folder on ti.com. In the upper right corner, click on *Alert me* to register and receive a weekly digest of any product information that has changed. For change details, review the revision history included in any revised document.

### 13.4 Community Resources

The following links connect to TI community resources. Linked contents are provided "AS IS" by the respective contributors. They do not constitute TI specifications and do not necessarily reflect TI's views; see TI's [Terms of Use](#).

**TI E2E™ Online Community** *TI's Engineer-to-Engineer (E2E) Community*. Created to foster collaboration among engineers. At e2e.ti.com, you can ask questions, share knowledge, explore ideas and help solve problems with fellow engineers.

**Design Support** *TI's Design Support* Quickly find helpful E2E forums along with design support tools and contact information for technical support.

### 13.5 Trademarks

E2E is a trademark of Texas Instruments.  
All other trademarks are the property of their respective owners.

### 13.6 Electrostatic Discharge Caution



This integrated circuit can be damaged by ESD. Texas Instruments recommends that all integrated circuits be handled with appropriate precautions. Failure to observe proper handling and installation procedures can cause damage.

ESD damage can range from subtle performance degradation to complete device failure. Precision integrated circuits may be more susceptible to damage because very small parametric changes could cause the device not to meet its published specifications.

## 13.7 Glossary

[SLYZ022](#) — *TI Glossary*.

This glossary lists and explains terms, acronyms, and definitions.

## 14 Mechanical, Packaging, and Orderable Information

The following pages include mechanical packaging and orderable information. This information is the most current data available for the designated devices. This data is subject to change without notice and revision of this document. For browser-based versions of this data sheet, refer to the left-hand navigation.

**PACKAGING INFORMATION**

Orderable Device	Status (1)	Package Type	Package Drawing	Pins	Package Qty	Eco Plan (2)	Lead finish/ Ball material (6)	MSL Peak Temp (3)	Op Temp (°C)	Device Marking (4/5)	Samples
REF6225IDGKR	ACTIVE	VSSOP	DGK	8	2500	RoHS & Green	NIPDAU	Level-2-260C-1 YEAR	-40 to 125	16ZV	<a href="#">Samples</a>
REF6225IDGKT	ACTIVE	VSSOP	DGK	8	250	RoHS & Green	NIPDAU	Level-2-260C-1 YEAR	-40 to 125	16ZV	<a href="#">Samples</a>
REF6230IDGKR	ACTIVE	VSSOP	DGK	8	2500	RoHS & Green	NIPDAU	Level-2-260C-1 YEAR	-40 to 125	17CV	<a href="#">Samples</a>
REF6230IDGKT	ACTIVE	VSSOP	DGK	8	250	RoHS & Green	NIPDAU	Level-2-260C-1 YEAR	-40 to 125	17CV	<a href="#">Samples</a>
REF6233IDGKR	ACTIVE	VSSOP	DGK	8	2500	RoHS & Green	NIPDAU	Level-2-260C-1 YEAR	-40 to 125	17DV	<a href="#">Samples</a>
REF6233IDGKT	ACTIVE	VSSOP	DGK	8	250	RoHS & Green	NIPDAU	Level-2-260C-1 YEAR	-40 to 125	17DV	<a href="#">Samples</a>
REF6241IDGKR	ACTIVE	VSSOP	DGK	8	2500	RoHS & Green	NIPDAU	Level-2-260C-1 YEAR	-40 to 125	17EV	<a href="#">Samples</a>
REF6241IDGKT	ACTIVE	VSSOP	DGK	8	250	RoHS & Green	NIPDAU	Level-2-260C-1 YEAR	-40 to 125	17EV	<a href="#">Samples</a>
REF6245IDGKR	ACTIVE	VSSOP	DGK	8	2500	RoHS & Green	NIPDAU	Level-2-260C-1 YEAR	-40 to 125	17FV	<a href="#">Samples</a>
REF6245IDGKT	ACTIVE	VSSOP	DGK	8	250	RoHS & Green	NIPDAU	Level-2-260C-1 YEAR	-40 to 125	17FV	<a href="#">Samples</a>
REF6250IDGKR	ACTIVE	VSSOP	DGK	8	2500	RoHS & Green	NIPDAU	Level-2-260C-1 YEAR	-40 to 125	17GV	<a href="#">Samples</a>
REF6250IDGKT	ACTIVE	VSSOP	DGK	8	250	RoHS & Green	NIPDAU	Level-2-260C-1 YEAR	-40 to 125	17GV	<a href="#">Samples</a>

(1) The marketing status values are defined as follows:

**ACTIVE:** Product device recommended for new designs.

**LIFEBUY:** TI has announced that the device will be discontinued, and a lifetime-buy period is in effect.

**NRND:** Not recommended for new designs. Device is in production to support existing customers, but TI does not recommend using this part in a new design.

**PREVIEW:** Device has been announced but is not in production. Samples may or may not be available.

**OBSOLETE:** TI has discontinued the production of the device.

(2) **RoHS:** TI defines "RoHS" to mean semiconductor products that are compliant with the current EU RoHS requirements for all 10 RoHS substances, including the requirement that RoHS substance do not exceed 0.1% by weight in homogeneous materials. Where designed to be soldered at high temperatures, "RoHS" products are suitable for use in specified lead-free processes. TI may reference these types of products as "Pb-Free".

**RoHS Exempt:** TI defines "RoHS Exempt" to mean products that contain lead but are compliant with EU RoHS pursuant to a specific EU RoHS exemption.

**Green:** TI defines "Green" to mean the content of Chlorine (Cl) and Bromine (Br) based flame retardants meet JS709B low halogen requirements of <=1000ppm threshold. Antimony trioxide based flame retardants must also meet the <=1000ppm threshold requirement.

- (3) MSL, Peak Temp. - The Moisture Sensitivity Level rating according to the JEDEC industry standard classifications, and peak solder temperature.
- (4) There may be additional marking, which relates to the logo, the lot trace code information, or the environmental category on the device.
- (5) Multiple Device Markings will be inside parentheses. Only one Device Marking contained in parentheses and separated by a "~" will appear on a device. If a line is indented then it is a continuation of the previous line and the two combined represent the entire Device Marking for that device.
- (6) Lead finish/Ball material - Orderable Devices may have multiple material finish options. Finish options are separated by a vertical ruled line. Lead finish/Ball material values may wrap to two lines if the finish value exceeds the maximum column width.

**Important Information and Disclaimer:**The information provided on this page represents TI's knowledge and belief as of the date that it is provided. TI bases its knowledge and belief on information provided by third parties, and makes no representation or warranty as to the accuracy of such information. Efforts are underway to better integrate information from third parties. TI has taken and continues to take reasonable steps to provide representative and accurate information but may not have conducted destructive testing or chemical analysis on incoming materials and chemicals. TI and TI suppliers consider certain information to be proprietary, and thus CAS numbers and other limited information may not be available for release.

In no event shall TI's liability arising out of such information exceed the total purchase price of the TI part(s) at issue in this document sold by TI to Customer on an annual basis.



DGK (S-PDSO-G8)

PLASTIC SMALL-OUTLINE PACKAGE

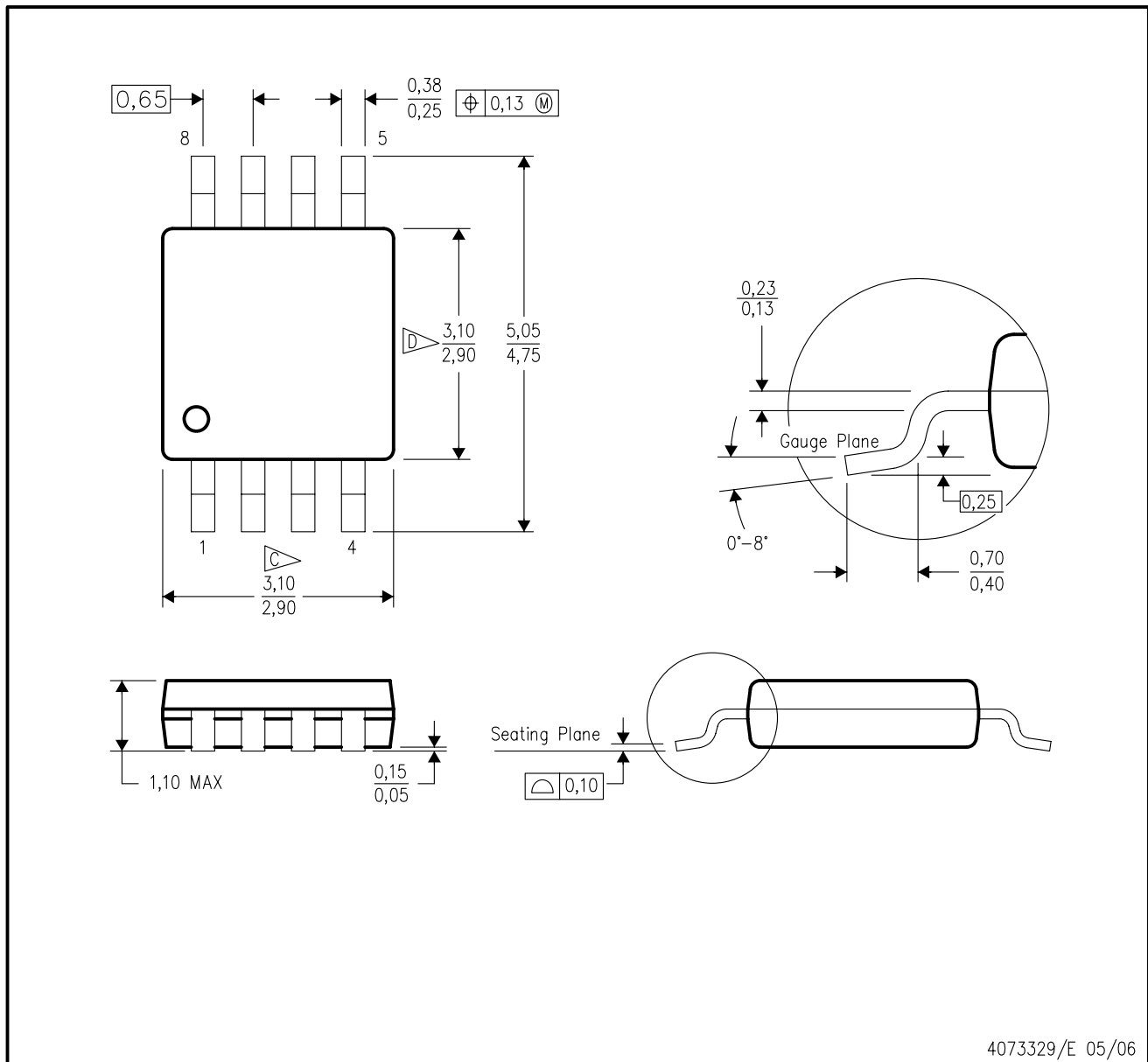

4073329/E 05/06

- NOTES:
- A. All linear dimensions are in millimeters.
  - B. This drawing is subject to change without notice.
  - C. Body length does not include mold flash, protrusions, or gate burrs. Mold flash, protrusions, or gate burrs shall not exceed 0.15 per end.
  - D. Body width does not include interlead flash. Interlead flash shall not exceed 0.50 per side.
  - E. Falls within JEDEC MO-187 variation AA, except interlead flash.

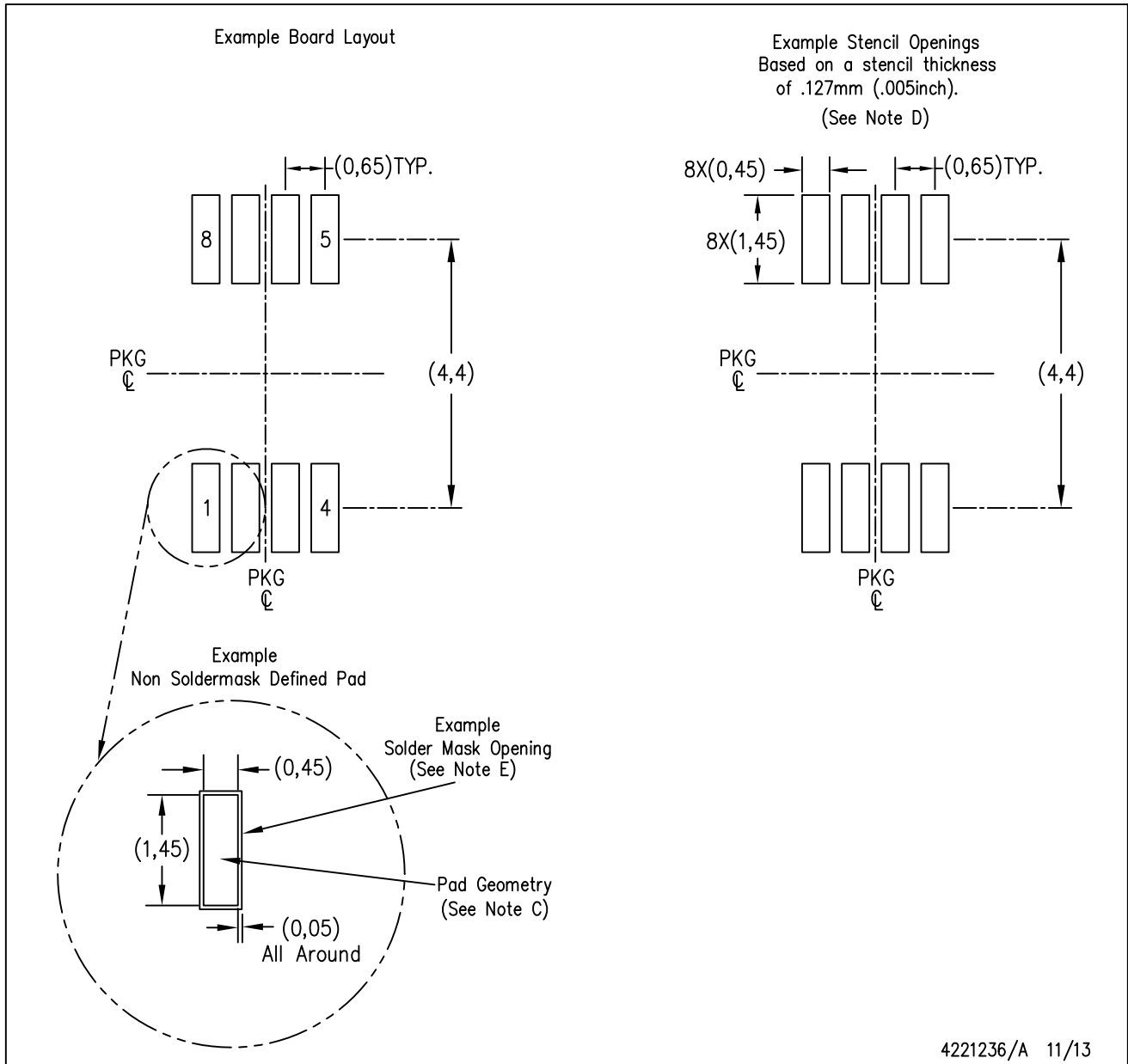

- NOTES:
- A. All linear dimensions are in millimeters.
  - B. This drawing is subject to change without notice.
  - C. Publication IPC-7351 is recommended for alternate designs.
  - D. Laser cutting apertures with trapezoidal walls and also rounding corners will offer better paste release. Customers should contact their board assembly site for stencil design recommendations. Refer to IPC-7525 for other stencil recommendations.
  - E. Customers should contact their board fabrication site for solder mask tolerances between and around signal pads.

## IMPORTANT NOTICE AND DISCLAIMER

TI PROVIDES TECHNICAL AND RELIABILITY DATA (INCLUDING DATASHEETS), DESIGN RESOURCES (INCLUDING REFERENCE DESIGNS), APPLICATION OR OTHER DESIGN ADVICE, WEB TOOLS, SAFETY INFORMATION, AND OTHER RESOURCES "AS IS" AND WITH ALL FAULTS, AND DISCLAIMS ALL WARRANTIES, EXPRESS AND IMPLIED, INCLUDING WITHOUT LIMITATION ANY IMPLIED WARRANTIES OF MERCHANTABILITY, FITNESS FOR A PARTICULAR PURPOSE OR NON-INFRINGEMENT OF THIRD PARTY INTELLECTUAL PROPERTY RIGHTS.

These resources are intended for skilled developers designing with TI products. You are solely responsible for (1) selecting the appropriate TI products for your application, (2) designing, validating and testing your application, and (3) ensuring your application meets applicable standards, and any other safety, security, or other requirements. These resources are subject to change without notice. TI grants you permission to use these resources only for development of an application that uses the TI products described in the resource. Other reproduction and display of these resources is prohibited. No license is granted to any other TI intellectual property right or to any third party intellectual property right. TI disclaims responsibility for, and you will fully indemnify TI and its representatives against, any claims, damages, costs, losses, and liabilities arising out of your use of these resources.

TI's products are provided subject to TI's Terms of Sale ([www.ti.com/legal/termsofsale.html](http://www.ti.com/legal/termsofsale.html)) or other applicable terms available either on [ti.com](http://ti.com) or provided in conjunction with such TI products. TI's provision of these resources does not expand or otherwise alter TI's applicable warranties or warranty disclaimers for TI products.

Mailing Address: Texas Instruments, Post Office Box 655303, Dallas, Texas 75265  
Copyright © 2020, Texas Instruments Incorporated