

Double Balanced Mixer

17 - 53 GHz



MAMX-011122

Rev. V3

Features

- Passive Mixer - No Bias Required
- Low Conversion Loss: 8 dB
- Nominal LO drive of +15 dBm
- 20 dBm IIP3
- 40 dB LO to IF Isolation
- Wide IF Bandwidth: DC to 20 GHz
- 3 mm 12-Lead AQFN
- RoHS* Compliant

Applications

- Test & Measurement
- Microwave Radio
- Radar

Description

MAMX-011122 is a double balanced mixer MMIC. The mixer offers wide bandwidth, low conversion loss and high linearity.

Functional Schematic

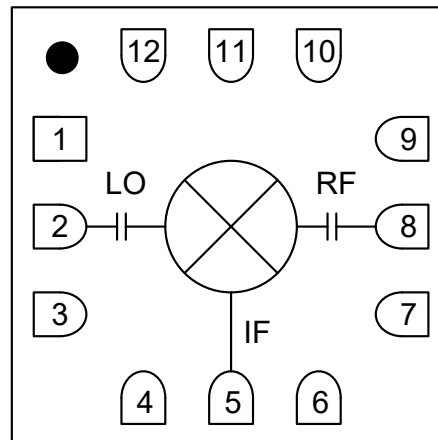

Pin Configuration

Pin #	Function
1,3,4,6,7,9	GND
2	LO
5	IF
8	RF
10 - 12	NC ³
13	GND ⁴

3. MACOM recommends connecting unused package pins to ground.
4. The exposed pad centered on the package bottom must be connected to RF, DC and thermal ground.

Ordering Information

Part Number	Package
MAMX-011122	Bulk
MAMX-011122-TR0100	100 Piece Reel ¹
MAMX-011122-TR0500	500 Piece Reel ¹
MAMX-011122-SMB	Sample Board ²

1. Reference Application Note M513 for reel size information.
2. All sample boards include 3 loose parts.

* Restrictions on Hazardous Substances, compliant to current RoHS EU directive.

Double Balanced Mixer

17 - 53 GHz



MAMX-011122

Rev. V3

Electrical Specifications⁵: $F_{IF} = 1 \text{ GHz}$, $P_{LO} = 15 \text{ dBm}$, $T_A = +25^\circ\text{C}$, $Z_0 = 50 \Omega$

Parameter	Test Conditions	Units	Min.	Typ.	Max.
LO and RF Frequency	—	GHz	17	—	53
IF Frequency	—	GHz	0	—	20
LO Power	—	dBm	—	15	—
Conversion Loss	17 - 50 GHz 50 - 53 GHz	dB	—	8 10	12 —
Input P1dB	17 - 53 GHz	dBm	—	9	—
Input IP3	$P_{RF} = -10 \text{ dBm/tone}$, $\Delta f = 1 \text{ MHz}$	dBm	—	20	—
Input IP2	$P_{RF} = -10 \text{ dBm/tone}$, $\Delta f = 1 \text{ MHz}$	dBm	—	40	—
Isolation LO-to-RF	17 - 53 GHz	dB	—	40	—
Isolation LO-to-IF	17 - 53 GHz	dB	—	40	—
Isolation RF-to-IF	17 - 30 GHz 30 - 53 GHz	dB	—	25 40	—
RF Return Loss	RF = 41 GHz	dB	—	6	—
LO Return Loss	LO = 41 GHz	dB	—	8	—
IF Return Loss	IF = 1 GHz	dB	—	12	—

5. All specifications refer to down-conversion operation, unless otherwise noted.

Absolute Maximum Ratings^{6,7}

Parameter	Absolute Maximum
LO Power	23 dBm
RF or IF Power	20 dBm
Storage Temperature	-65°C to +150°C

6. Exceeding any one or combination of these limits may cause permanent damage to this device.
7. MACOM does not recommend sustained operation near these survivability limits.

Maximum Operating Condition

Parameter	Maximum
LO Power	19 dBm
Junction Temperature ⁸	+150°C
Operating Temperature	-40°C to +85°C

8. Operating at nominal conditions with $T_J \leq +150^\circ\text{C}$ will ensure $MTTF > 1 \times 10^6$ hours. Thermal resistance, Θ_{JC} is TBD° C/W.

Handling Procedures

Please observe the following precautions to avoid damage:

Static Sensitivity

These electronic devices are sensitive to electrostatic discharge (ESD) and can be damaged by static electricity. Proper ESD control techniques should be used when handling these devices. The ESD JEDEC classification is Class 1B HBM.

Double Balanced Mixer

17 - 53 GHz



MAMX-011122

Rev. V3

PCB Layout

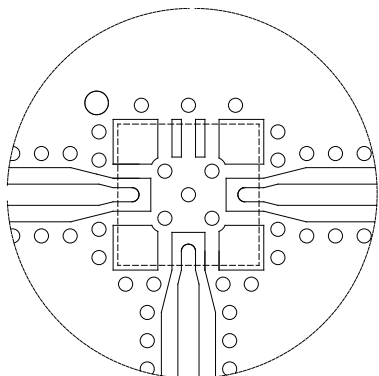

DXF available on request based on 10 mil RO4350 substrate.

Application Schematic

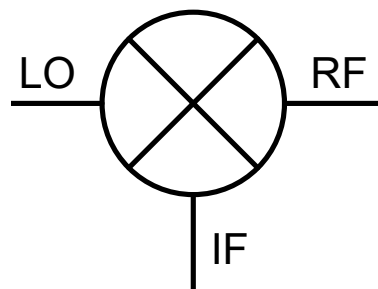

No external parts required for operation of MAMX-011088.

Evaluation Board

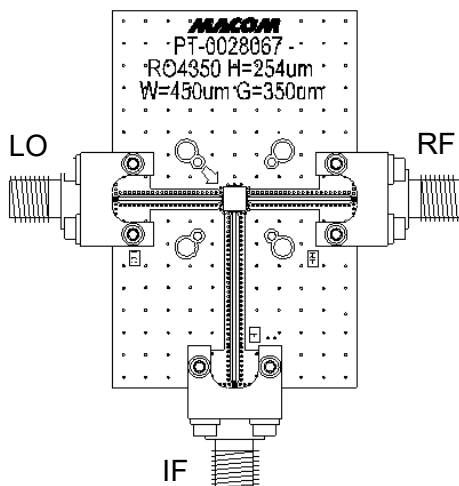

Evaluation Board Losses

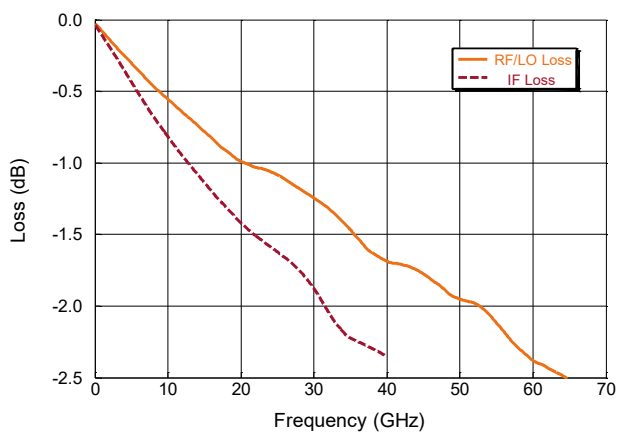

Double Balanced Mixer

17 - 53 GHz



MAMX-011122

Rev. V3

Typical Performance Curves: Down Conversion Mode, Upper Side Band (USB), Low Side LO @ 25°C. IF = 1 GHz

Conversion Loss vs. Frequency

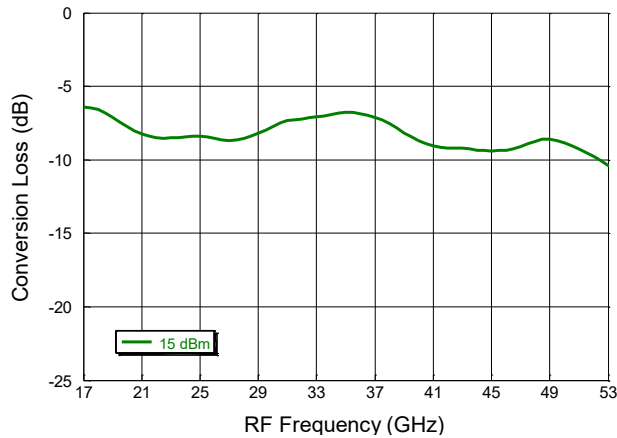

Conversion Loss over LO Drive

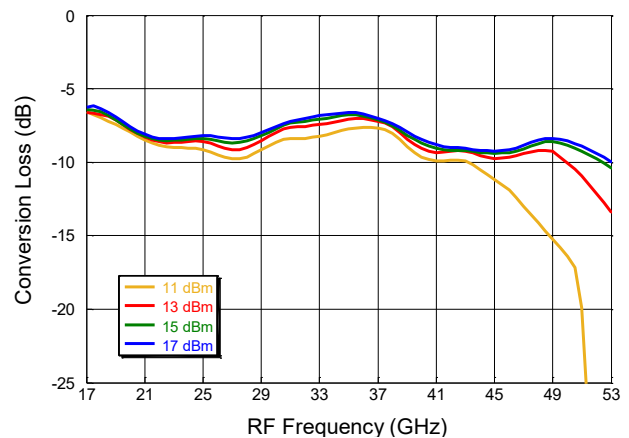

IIP3 over LO Drive vs. RF Frequency

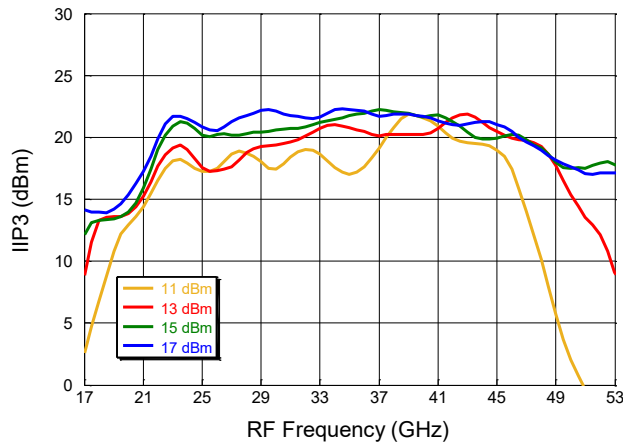

IIP2 over LO Drive vs. RF Frequency

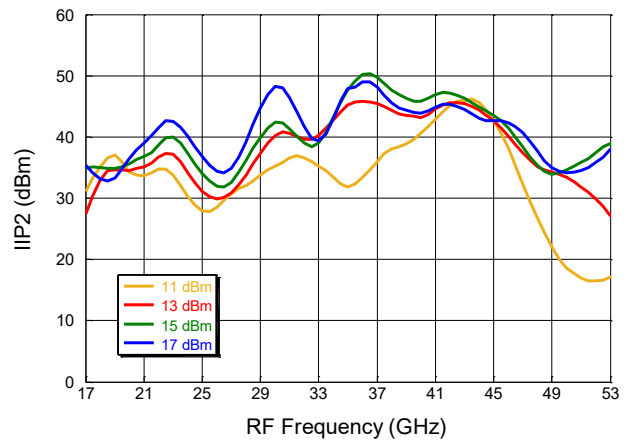

P1dB vs. RF Frequency

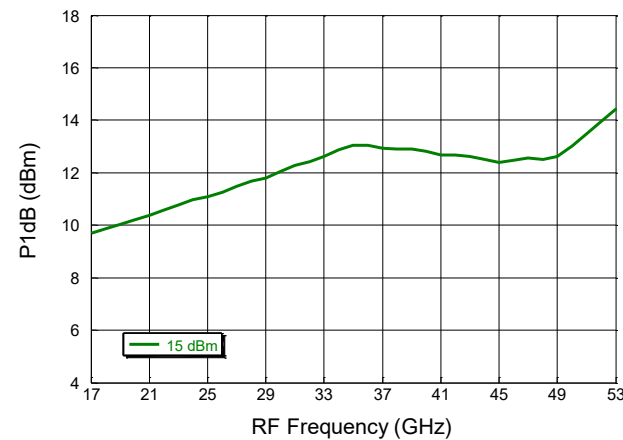

Isolations vs. RF Frequency

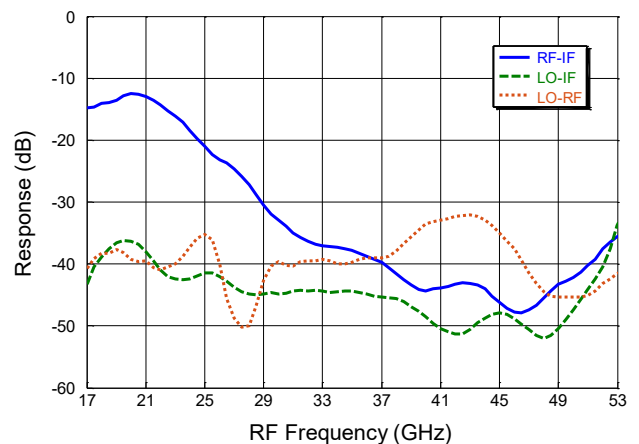

Double Balanced Mixer

17 - 53 GHz



MAMX-011122

Rev. V3

Typical Performance Curves: Down Conversion Mode, Upper Side Band (USB), Low Side LO @ 25°C. IF = 1 GHz

RF Return Loss vs. RF Frequency

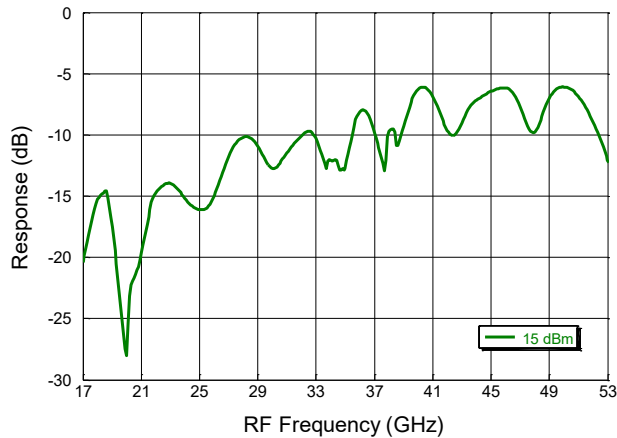

LO Return Loss vs. RF Frequency

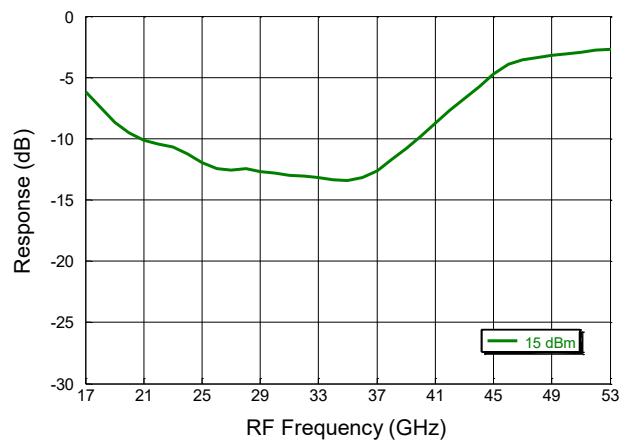

IF Return Loss vs. IF Frequency

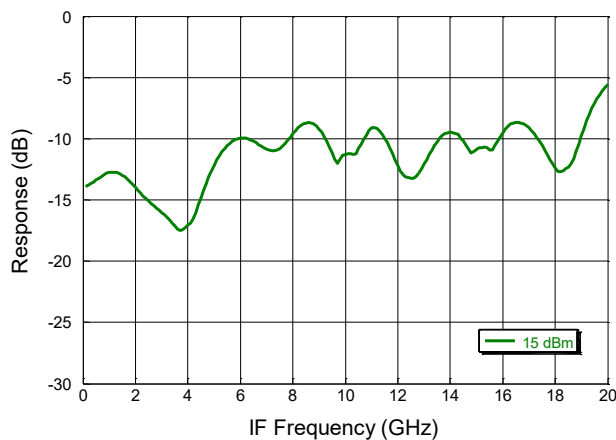

IF Bandwidth vs. IF Frequency

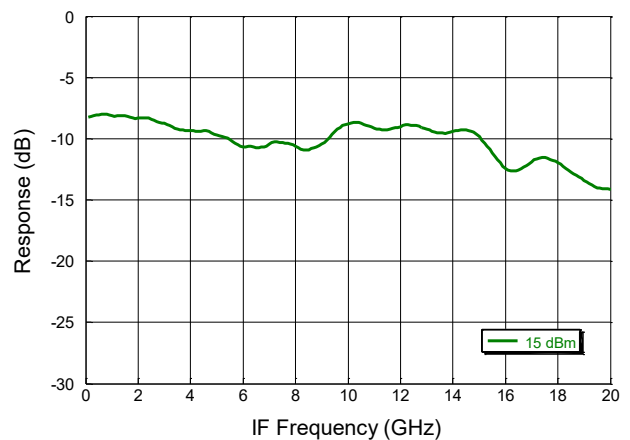

2RF x 2LO Spurious Suppression

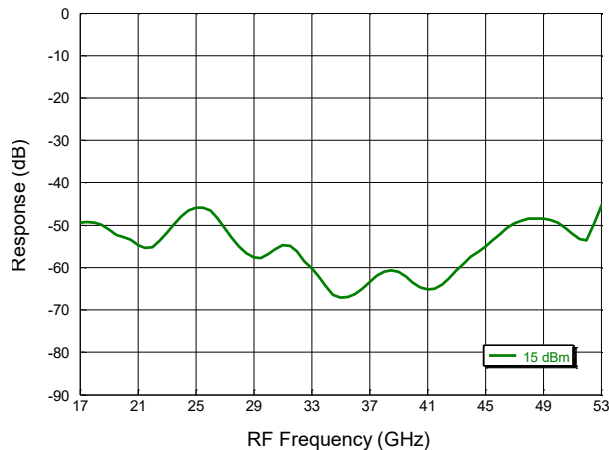

Double Balanced Mixer

17 - 53 GHz



MAMX-011122

Rev. V3

Typical Performance Curves: Down Conversion Mode, Upper Side Band (USB), Over Temperature. IF = 1 GHz

Conversion Loss over Temperature @ $P_{LO} = 15$ dBm

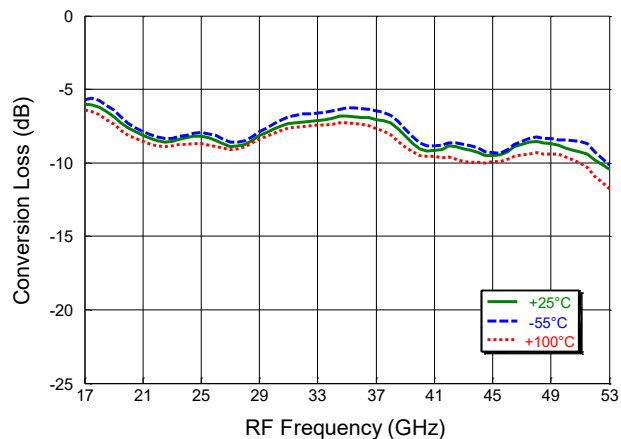

IIP2 over Temperature @ $P_{LO} = 15$ dBm

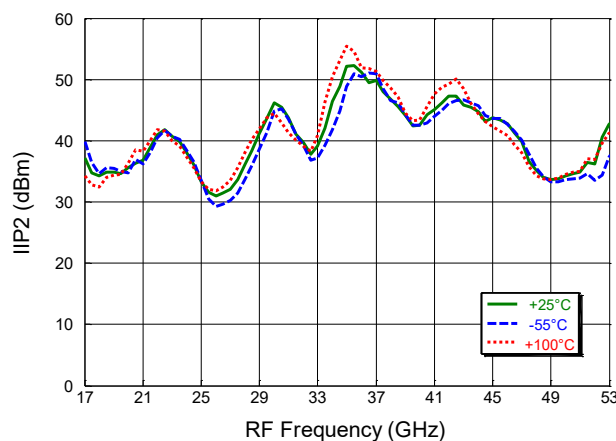

IIP3 over Temperature @ $P_{LO} = 15$ dBm

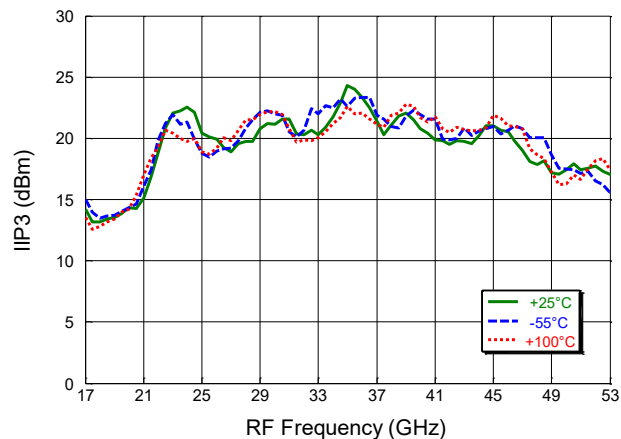

Double Balanced Mixer

17 - 53 GHz



MAMX-011122

Rev. V3

Typical Performance Curves: Down Conversion Mode, Upper Side Band (USB), Low Side LO @ 25°C. IF = 100 MHz

Conversion Loss vs. Frequency

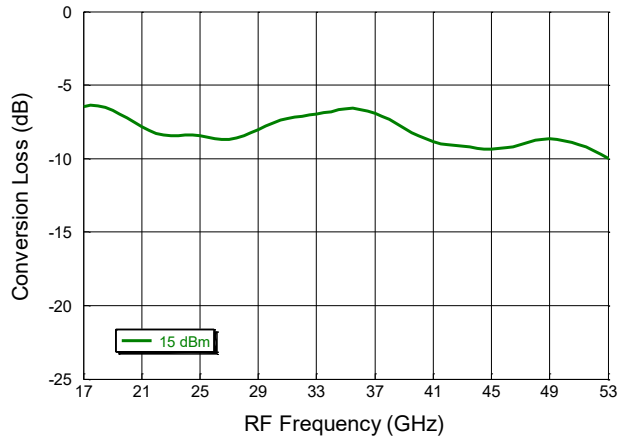

Conversion Loss over LO Drive

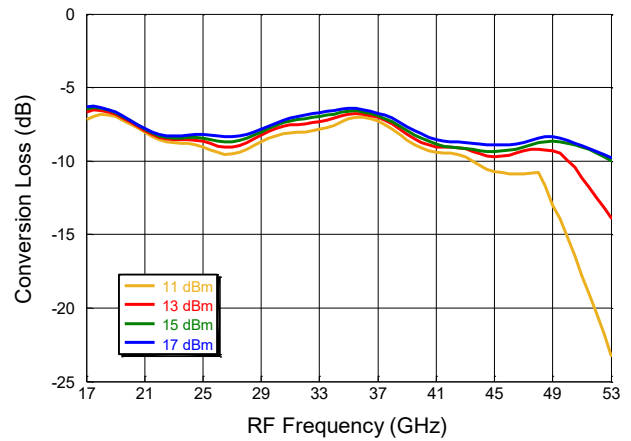

IIP3 over LO Drive vs. RF Frequency

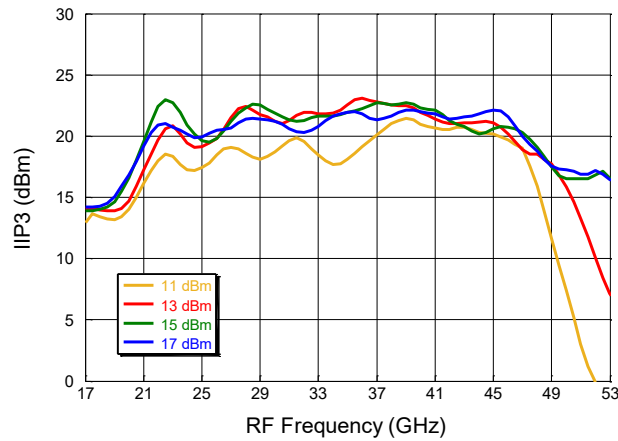

IIP2 over LO Drive vs. RF Frequency

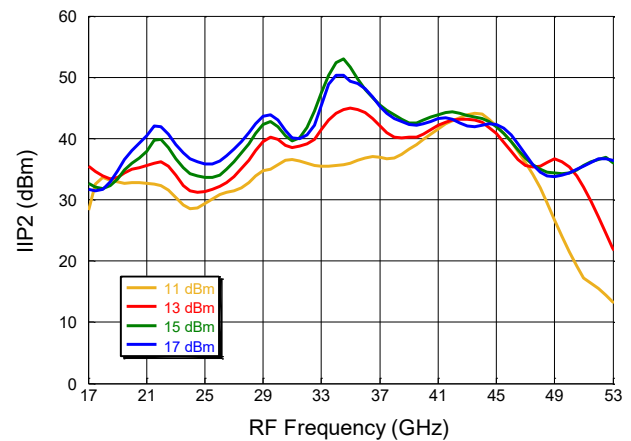

Double Balanced Mixer

17 - 53 GHz



MAMX-011122

Rev. V3

Typical Performance Curves: Down Conversion Mode, Upper Side Band (USB), Low Side LO @ 25°C. IF = 10 GHz

Conversion Loss vs. Frequency

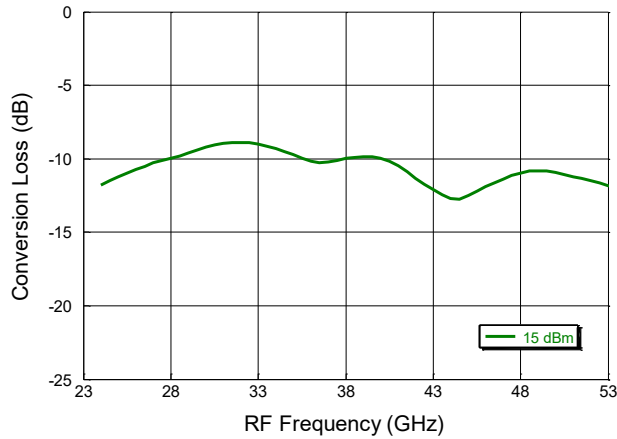

Conversion Loss over LO Drive

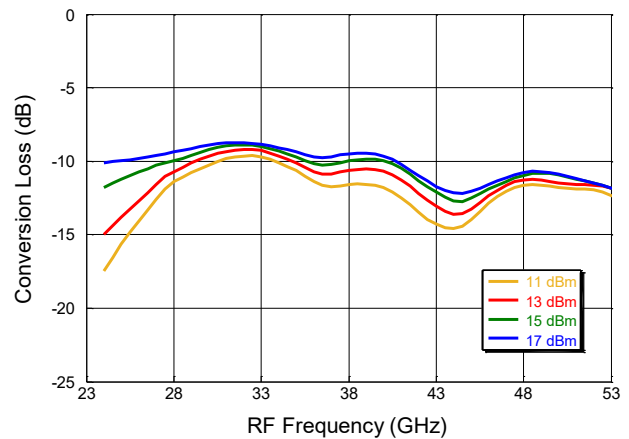

IIP3 over LO Drive vs. RF Frequency

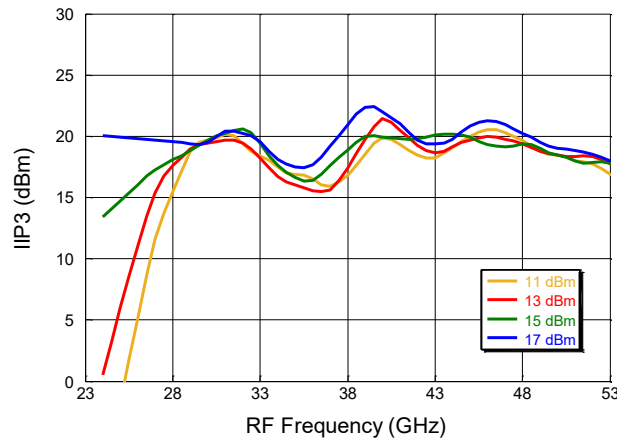

IIP2 over LO Drive vs. RF Frequency

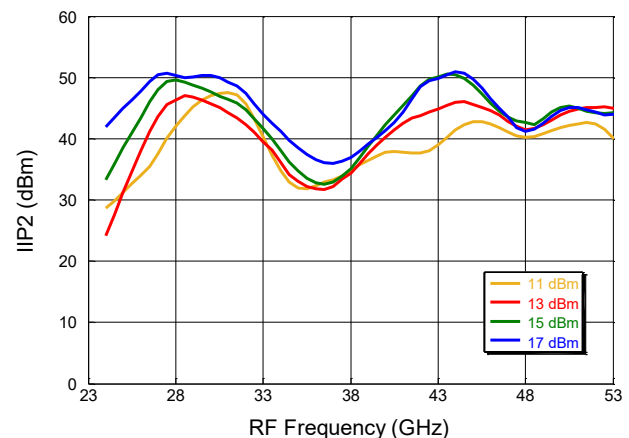

Double Balanced Mixer

17 - 53 GHz



MAMX-011122

Rev. V3

Typical Performance Curves: Down Conversion Mode, Upper Side Band (USB), Low Side LO @ 25°C. IF = 20 GHz

Conversion Loss vs. Frequency

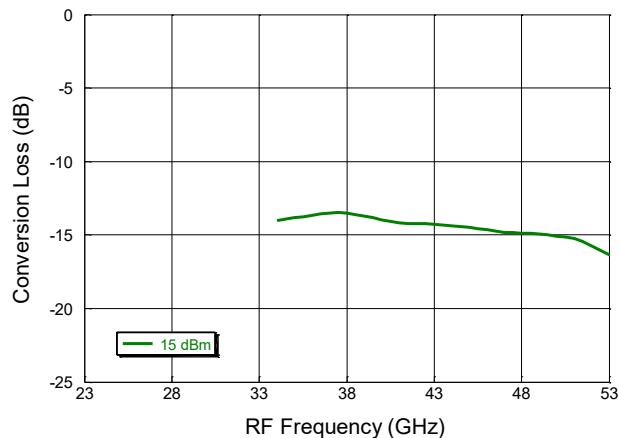

Conversion Loss over LO Drive

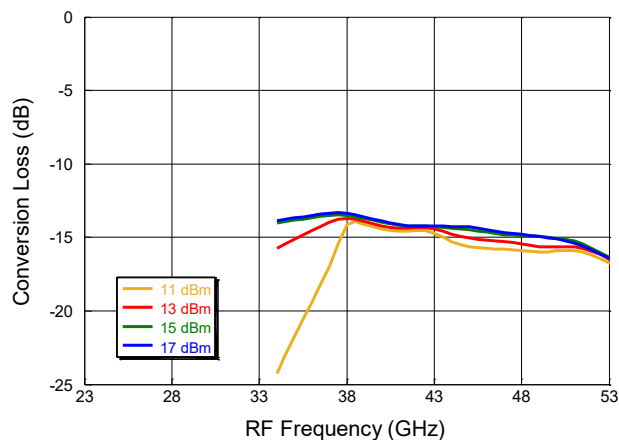

IIP3 over LO Drive vs. RF Frequency

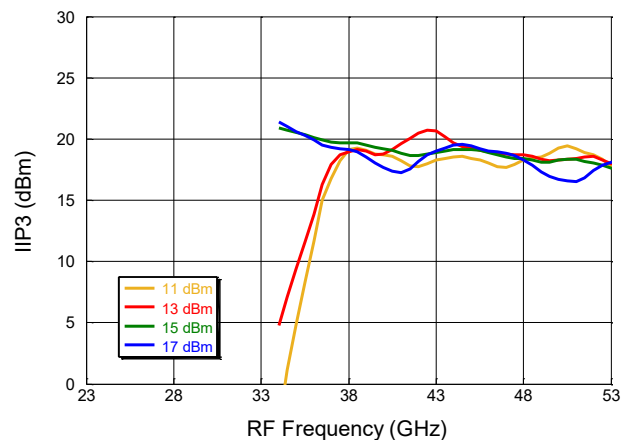

Double Balanced Mixer

17 - 53 GHz



MAMX-011122

Rev. V3

Typical Performance Curves: Up Conversion Mode, Upper Side Band (USB),
Low Side LO @ 25°C. IF = 1 GHz

Conversion Loss vs. Frequency

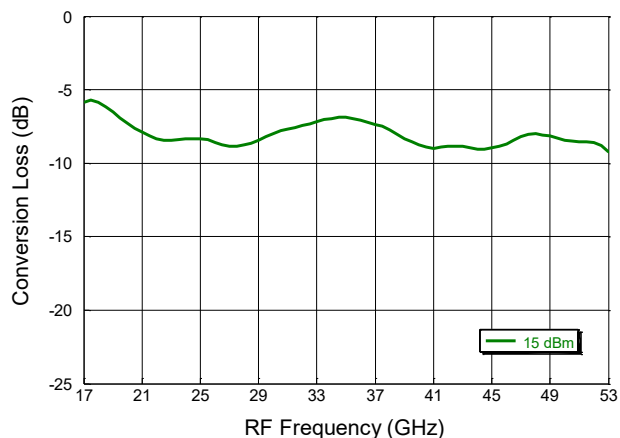

Conversion Loss over LO Drive

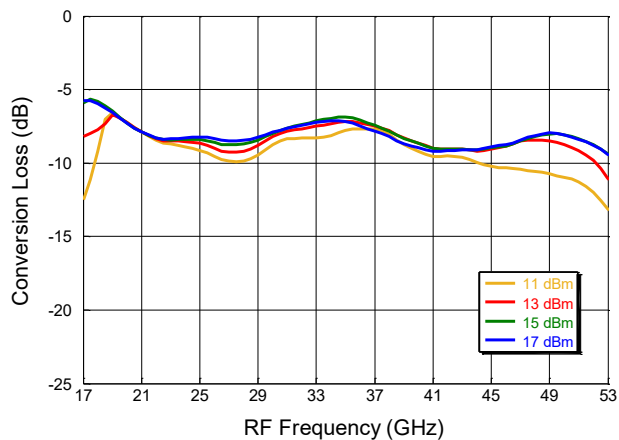

Double Balanced Mixer

17 - 53 GHz



MAMX-011122

Rev. V3

MxN Spurious Rejection at IF Port (dBc IF)

RF = 25 GHz @ -15 dBm

LO = 24 GHz @ +15 dBm

mxRF	nxLO				
	0	1	2	3	4
0	X	5	16	X	X
1	14	0	12	48	X
2	X	66	46	54	X
3	X	X	84	55	71
4	X	X	X	X	X

RF = 35 GHz @ -15 dBm

LO = 34 GHz @ +15 dBm

mxRF	nxLO				
	0	1	2	3	4
0	X	7	X	X	X
1	30	0	38	X	X
2	X	85	71	77	X
3	X	X	X	86	90
4	X	X	X	X	X

RF = 45 GHz @ -15 dBm

LO = 44 GHz @ +15 dBm

mxRF	nxLO				
	0	1	2	3	4
0	X	6	X	X	X
1	35	0	51	X	X
2	X	82	56	80	X
3	X	X	X	81	X
4	X	X	X	X	X

Double Balanced Mixer

17 - 53 GHz



MAMX-011122

Rev. V3

Lead-Free 3 mm 12-Lead QFN[†]

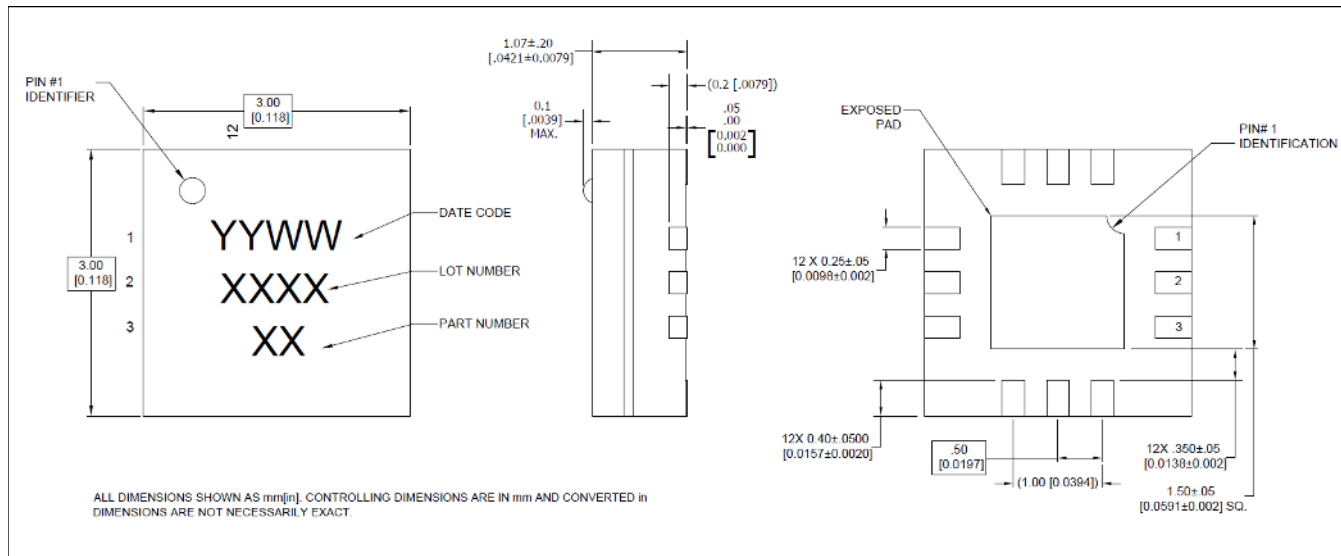

[†] Reference Application Note S2083 for lead-free solder reflow recommendations.
 Meets JEDEC moisture sensitivity level 1 requirements.
 Plating is 100% matte tin over copper.

Double Balanced Mixer

17 - 53 GHz



MAMX-011122

Rev. V3

MACOM Technology Solutions Inc. ("MACOM"). All rights reserved.

These materials are provided in connection with MACOM's products as a service to its customers and may be used for informational purposes only. Except as provided in its Terms and Conditions of Sale or any separate agreement, MACOM assumes no liability or responsibility whatsoever, including for (i) errors or omissions in these materials; (ii) failure to update these materials; or (iii) conflicts or incompatibilities arising from future changes to specifications and product descriptions, which MACOM may make at any time, without notice. These materials grant no license, express or implied, to any intellectual property rights.

THESE MATERIALS ARE PROVIDED "AS IS" WITH NO WARRANTY OR LIABILITY, EXPRESS OR IMPLIED, RELATING TO SALE AND/OR USE OF MACOM PRODUCTS INCLUDING FITNESS FOR A PARTICULAR PURPOSE, MERCHANTABILITY, INFRINGEMENT OF INTELLECTUAL PROPERTY RIGHT, ACCURACY OR COMPLETENESS, OR SPECIAL, INDIRECT, INCIDENTAL, OR CONSEQUENTIAL DAMAGES WHICH MAY RESULT FROM USE OF THESE MATERIALS.

MACOM products are not intended for use in medical, lifesaving or life sustaining applications. MACOM customers using or selling MACOM products for use in such applications do so at their own risk and agree to fully indemnify MACOM for any damages resulting from such improper use or sale.