

Features

- Lead Free Finish/RoHS Compliant (Note 1) ("P" Suffix Designates RoHS Compliant. See Ordering Information)
- Blocking Voltage: 800 to 1800V
- Three Phase Bridge and a Thyristor
- Isolated Module Package

Applications

- Inverter for AC or DC Motor Control
- Current Stabilized Power Supply
- Switching Power Supply

**100 Amp
Three Phase
Bridge + Thyristor
800~1800 Volts**

MCC Part Number	V_{RRM}/V_{DRM}	V_{RSM}
MT100DT08L1	800V	900V
MT100DT12L1	1200V	1300V
MT100DT16L1	1600V	1700V
MT100DT18L1	1800V	1900V

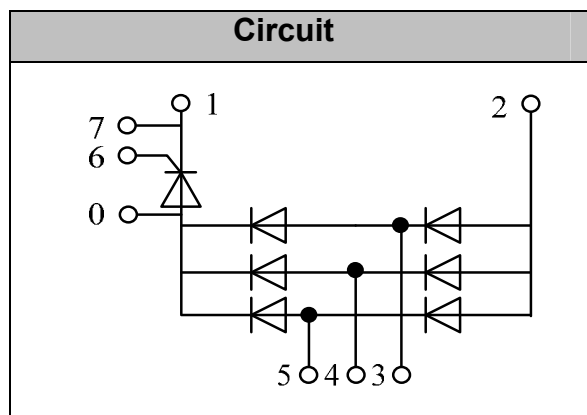
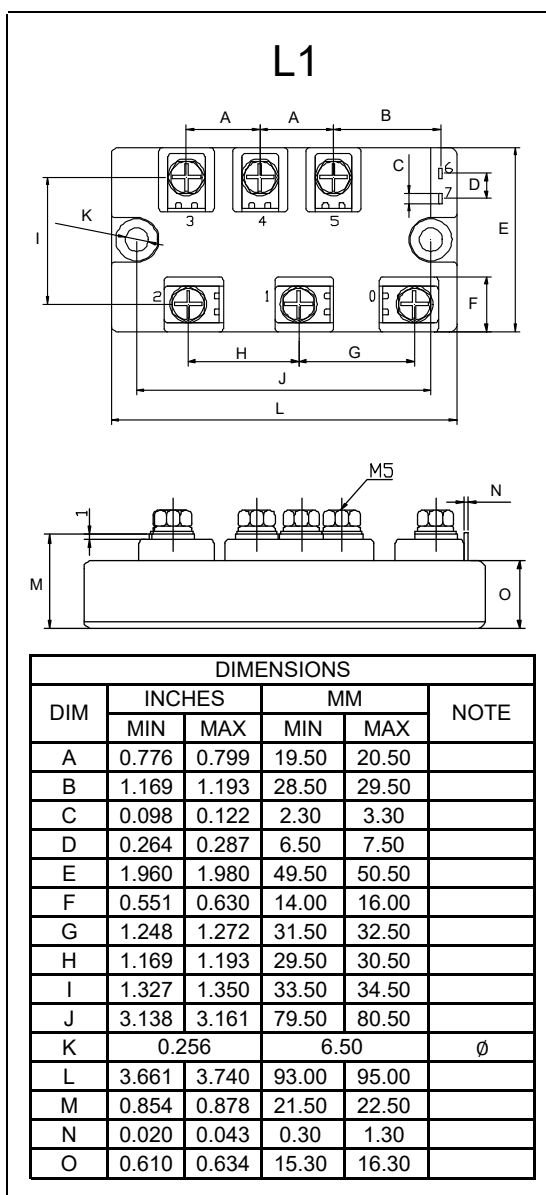
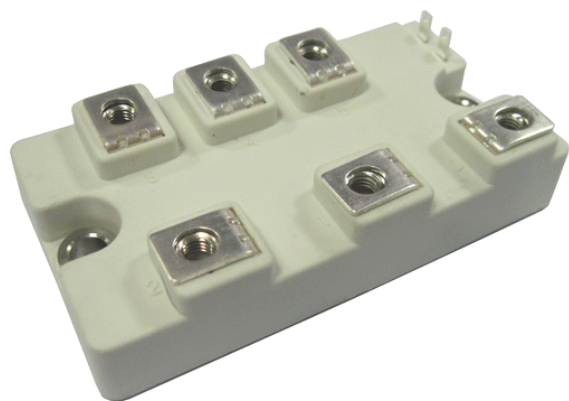

◆ Diode

Maximum Ratings

Symbol	Item	Conditions	Values	Units
ID	Output Current(D.C.)	Tc=100°C Three Phase Full Wave	100	A
IFSM	Surge Forward Current	t=10mS Tvj =45°C	1200	A
i ² t	Circuit Fusing Consideration		7200	A ² s
Visol	Isolation Breakdown Voltage(R.M.S)	a.c.50HZ;r.m.s.;1Min	3000	V
Tvj	Operating Junction Temperature		-40 to +150	°C
Tstg	Storage Temperature		-40 to +125	°C
Mt	Mounting Torque	To Terminals(M5)	3±15%	Nm
Ms		To Heatsink(M5)	3±15%	Nm
Weight		Module (Approximately)	210	g

Thermal Characteristics

Symbol	Item	Conditions	Values	Units
Rth _(J-C)	Thermal Impedance, Max.	Junction to Case(Total)	0.18	°C/W
Rth _(C-S)	Thermal Impedance, Max.	Case to Heatsink	0.10	°C/W

Electrical Characteristics

Symbol	Item	Conditions	Values	Units
VFM	Forward Voltage Drop, Max.	T=25°C IF =100A	1.35	V
I _{RRM}	Repetitive Peak Reverse Current, Max.	Tvj =25°C VRD=VRRM Tvj =150°C VRD=VRRM	≤0.5 ≤6	mA mA

◆Thyristor Maximum Ratings

Symbol	Item	Conditions	Values	Units
I_{TAV}	Average On-State Current	$T_c=92^{\circ}\text{C}$, Single Phase Half Wave 180° Conduction	100	A
I_{TSM}	Surge On-State Current	$T_{VJ}=45^{\circ}\text{C}$ $t=10\text{ms}$ (50Hz), Sine $V_R=0$	1200	A
i^2t	Circuit Fusing Consideration		7200	A^2s
Visol	Isolation Breakdown Voltage(R.M.S)	a.c.50Hz;r.m.s.;1 Min	3000	V
T_{vj}	Operating Junction Temperature		-40 to +125	$^{\circ}\text{C}$
T_{stg}	Storage Temperature		-40 to +125	$^{\circ}\text{C}$
M_t	Mounting Torque	To Terminals(M5)	$3\pm 15\%$	Nm
M_s		To Heatsink(M5)	$3\pm 15\%$	Nm
di/dt	Critical Rate of Rise of On-State Current	$T_{VJ}=T_{VJM}$, $V_D=1/2V_{DRM}$, $I_G=100\text{mA}$ $di_G/dt=0.1\text{A}/\mu\text{s}$	150	$\text{A}/\mu\text{s}$
dv/dt	Critical Rate of Rise of Off-State Voltage, Min.	$T_J=T_{VJM}$, $V_D=2/3V_{DRM}$, Linear Voltage Rise	500	$\text{V}/\mu\text{s}$

Electrical and Thermal Characteristics

Symbol	Item	Conditions	Values			Units
			Min.	Typ.	Max.	
V_{TM}	Peak On-State Voltage	$T=25^{\circ}\text{C}$ $I_T=100\text{A}$			1.25	V
I_{RRM}/I_{DRM}	Repetitive Peak Reverse Current / Repetitive Peak Off-State Current	$T_{VJ}=T_{VJM}$, $V_R=V_{RRM}$, V_D $=V_{DRM}$			20	mA
V_{GT}	Gate Trigger Voltage	$T_{VJ}=25^{\circ}\text{C}$, $V_D=6\text{V}$		1	3	V
I_{GT}	Gate Trigger Current	$T_{VJ}=25^{\circ}\text{C}$, $V_D=6\text{V}$		65	150	mA
I_H	Hoding Current	$T_{VJ}=25^{\circ}\text{C}$, $V_D=6\text{V}$		120	220	mA
I_L	latching Current	$T_{VJ}=25^{\circ}\text{C}$, $R=33\Omega$		180	400	mA
$R_{th(J-C)}$	Thermal Impedance	Junction to Case			0.26	$^{\circ}\text{C}/\text{W}$
$R_{th(C-S)}$	Thermal Impedance	Case to Heatsink			0.10	$^{\circ}\text{C}/\text{W}$

Performance Curves

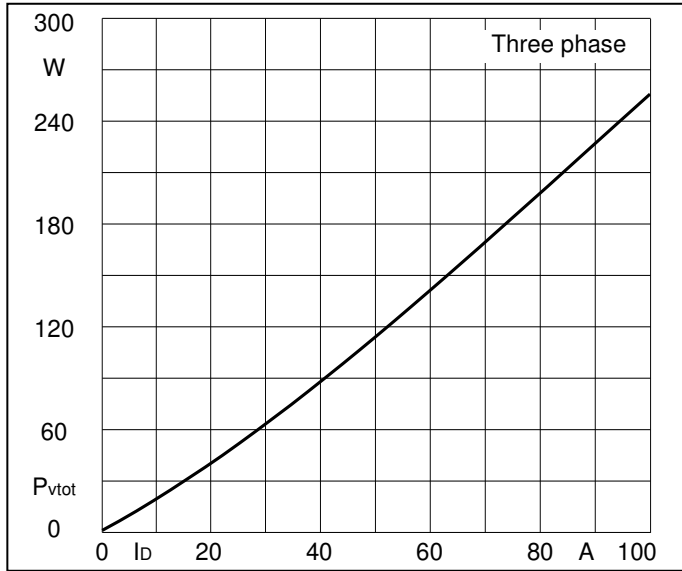

Fig1. Power dissipation

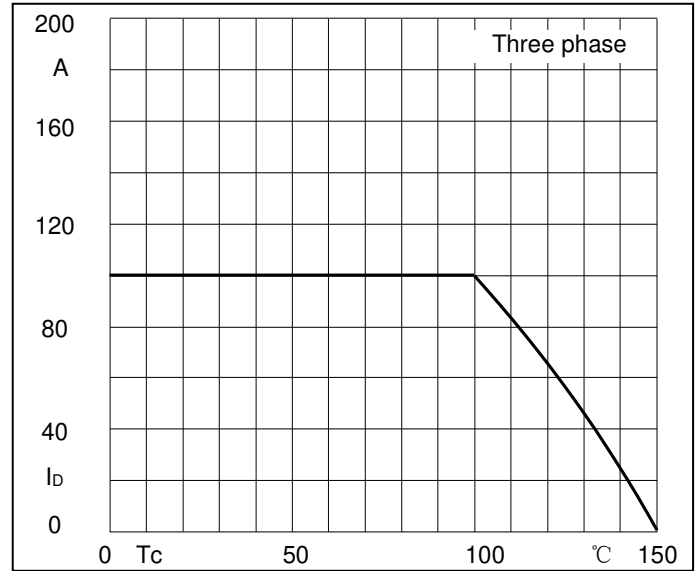

Fig2. Forward Current Derating Curve

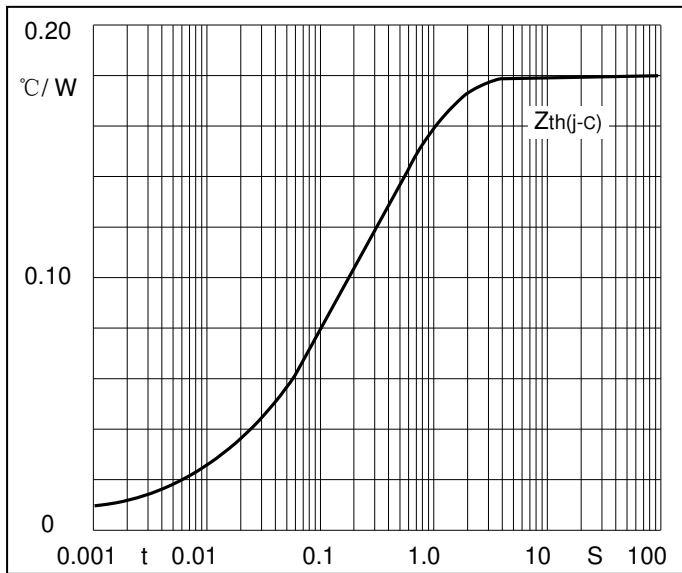

Fig3. Transient thermal impedance

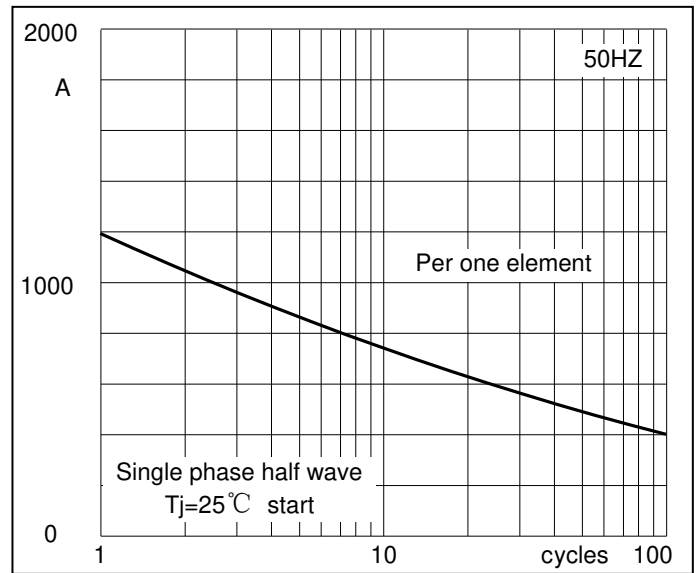

Fig4. Max Non-Repetitive Forward Surge Current

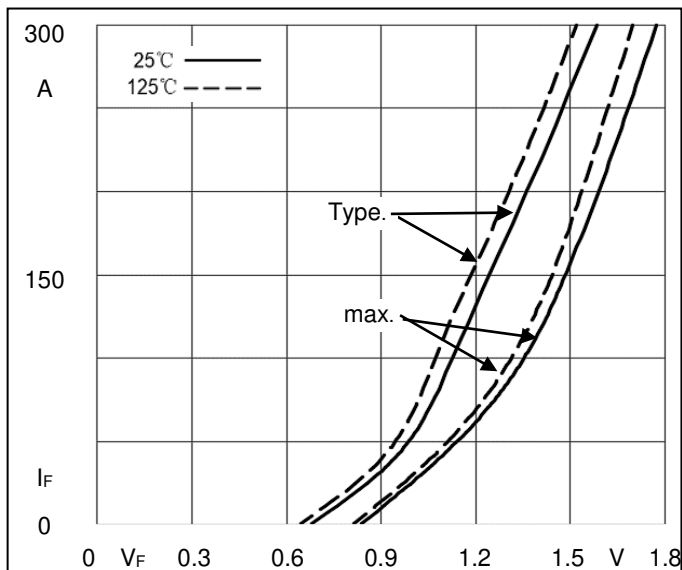

Fig5. Diode Forward Characteristics

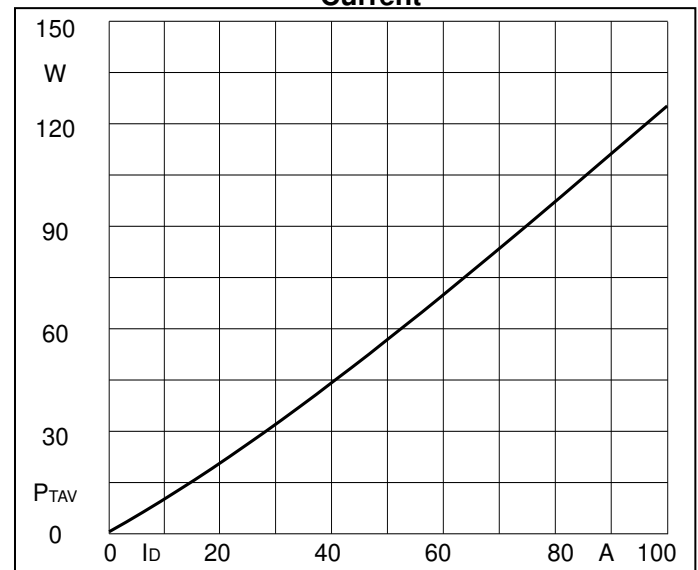

Fig6. SCR Power dissipation

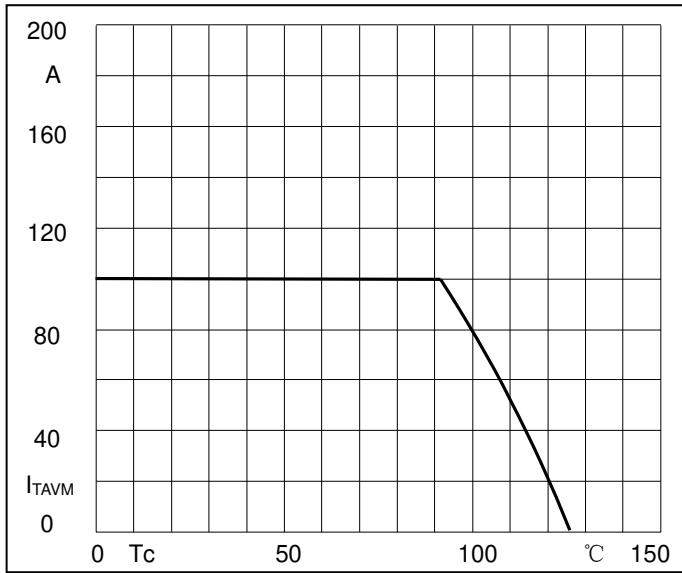

Fig7. SCR Forward Current Derating Curve

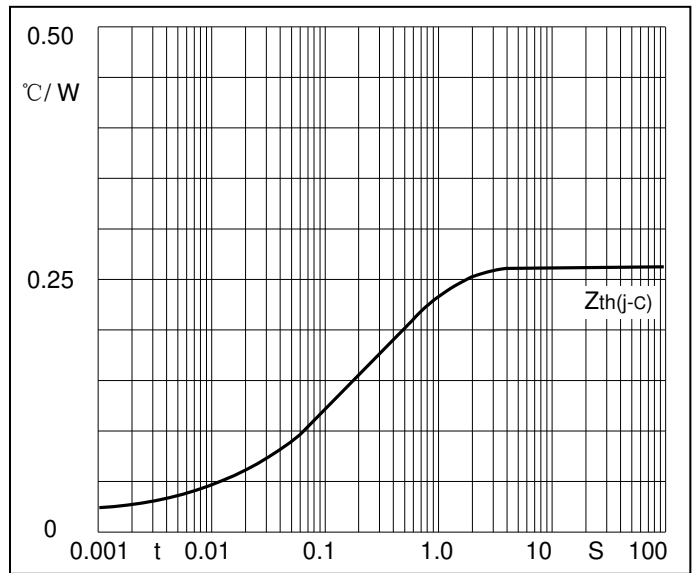

Fig8. SCR Transient thermal impedance

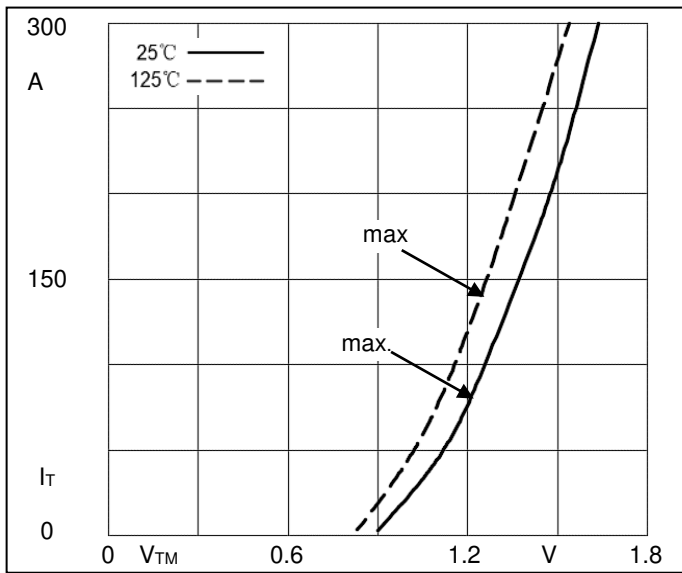

Fig9. SCR Forward Characteristics

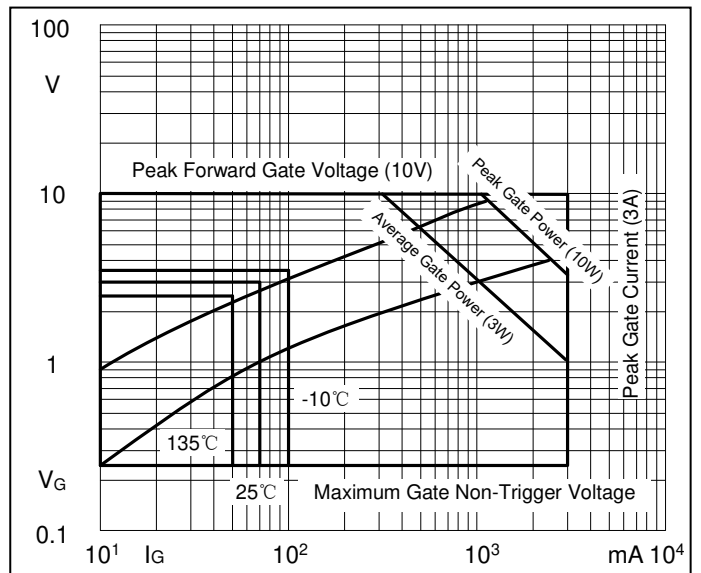

Fig10. Gate trigger Characteristics

Ordering Information

Device	Packing
Part Number-BP	Bulk: 6PCS/BOX ;60PCS/CTN

*****IMPORTANT NOTICE*****

Micro Commercial Components Corp. reserves the right to make changes without further notice to any product herein to make corrections, modifications, enhancements, improvements, or other changes. *Micro Commercial Components Corp.* does not assume any liability arising out of the application or use of any product described herein; neither does it convey any license under its patent rights, nor the rights of others. The user of products in such applications shall assume all risks of such use and will agree to hold *Micro Commercial Components Corp.* and all the companies whose products are represented on our website, harmless against all damages.

*****LIFE SUPPORT*****

MCC's products are not authorized for use as critical components in life support devices or systems without the express written approval of Micro Commercial Components Corporation.

*****CUSTOMER AWARENESS*****

Counterfeiting of semiconductor parts is a growing problem in the industry. Micro Commercial Components (MCC) is taking strong measures to protect ourselves and our customers from the proliferation of counterfeit parts. MCC strongly encourages customers to purchase MCC parts either directly from MCC or from Authorized MCC Distributors who are listed by country on our web page cited below. Products customers buy either from MCC directly or from Authorized MCC Distributors are genuine parts, have full traceability, meet MCC's quality standards for handling and storage. **MCC will not provide any warranty coverage or other assistance for parts bought from Unauthorized Sources.** MCC is committed to combat this global problem and encourage our customers to do their part in stopping this practice by buying direct or from authorized distributors.